

Fujikin®



PRODUCT CATALOG









V® COLLECTION









Index

Introduction	P
Introduction	1
Application & Achievement	2
Application	3, 4
Delivery Records	5, 6
Products Information	8–192

Fittings	8	
V-Lok Tube Fittings Double Rings Compression and Bite Type Stainless Steel	9	
PDW Tube Fittings Double Rings Compression and Bite Type Brass	85	

Valves	104		
Ball Valves	Manual Valves VUBV, VUBVS, VUBVT, VUBVST-920 Series	105	
	Automatic Operate Valves APR, APDM-VUBV, VUBVS-920 Series	111	
3-Pieces Ball Valves	Manual Valves VUBV-915 Series	115	
	Automatic Operate Valves APR, APDM-VUBV-915 Series	118	
Trunnion Ball Valves	Manual Valves VUBV, VUBVT-941, 968 Series	121	
Plug Valves	Manual Valves VUP-920 Series	127	
Union-Bonnet Needle Valves	Manual Valves VUH-941, 968 Series	131	
Integral-Bonnet Needle Stop Valves	Manual Valves VUH, VUN-934 Series	135	
Brass Needle Stop Valves	Manual Valves PDS, PDWVP Series	139	

Valves		104	
Instrument Manifolds / Gauge Valves	VUT, VUTW-141 Series	145	
Bellows Valves	VUBF, VUBFD-96 Series	161	
Toggle Valves	VUK-91 Series	169	
Relief Valves	VURF-041L Series	173	
Check Valves	VUCL-941 Series	177	

Other Related Products		180	
Automatic Flow Control Valve Series			
	Diaphragm Type Mini Control Valves MINUCON Series	181	
	Electric Valves SR100 Series	182	
	Electric Valves SR100E Series	183	
	Electric Valves AR2000 Series	184	
	Electric Valves SR100M Series	184	
Others			
FINE BUBBLE Leak Detection Fluid		187	

Technical Data		188
	V-Lok Tube Fittings PERFORMANCE CONFIRMATION TEST RESULTS	189
Technical Data	CERTIFICATE V-Lok Tube Fittings	192
	REMARKS Special Materials	193
	Oil-free Products	

Index	194
--------------------	------------

Introduction

Process & Instrumentation Valve Equipment for Oil & Gas and General Industries

Fujikin Incorporated's flow control technologies are state of the art everywhere: earth, ocean and sky.

Fujikin Incorporated

has become the top manufacturing corporation for not only specific-purpose valves but also super high precision flow control systems. Our cutting edge technology is used in every area that demands the highest technology.



Semiconductor



Solar and Fuel Cells



Aerospace



Marine Vessels



Iron and Steel



Nano Devices



Medical, Pharmaceutical and Food



Ocean Development



Petrochemicals



Cryogenic Equipment

Application & Achievement

Process & Instrumentation Valve Equipment for Oil & Gas and General Industries



Oil & Gas Production



Petrochemicals & Chemicals



Petroleum Refining



GTL / DME



LNG



Oil Platform

Holding a share of more than 80% of instrumentation valves for Oil & Gas plant in Japan, **Fujikin** contributes to safety, security and reliability of the nuclear power stations also.

Application



Electric Steam Trace Construction Example Layout

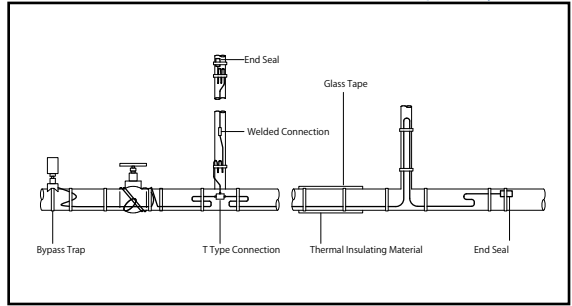

Gas Sampling System Layout

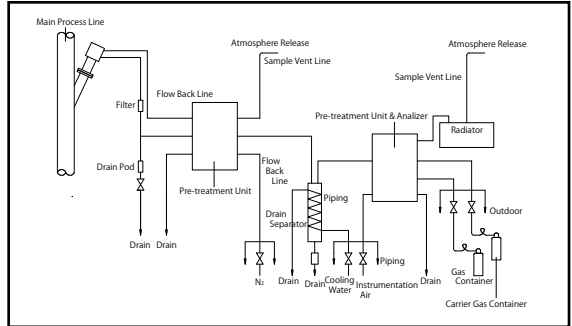

Air Header System Layout

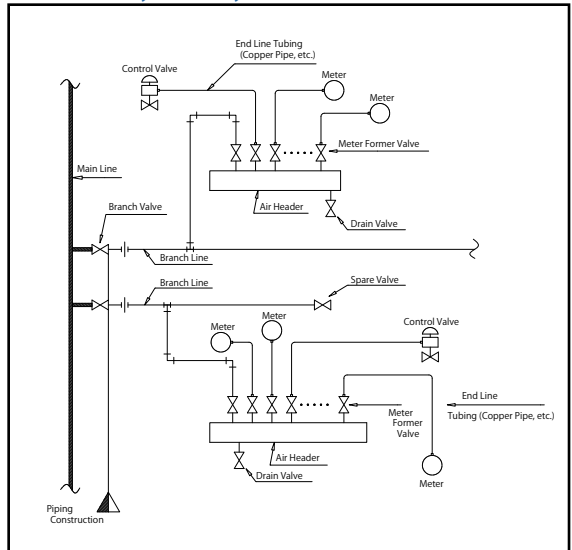

Floor Mount Line Model

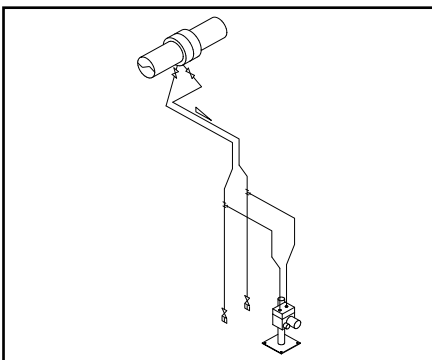

Sampling Nozzle: Horizontal Direction Model

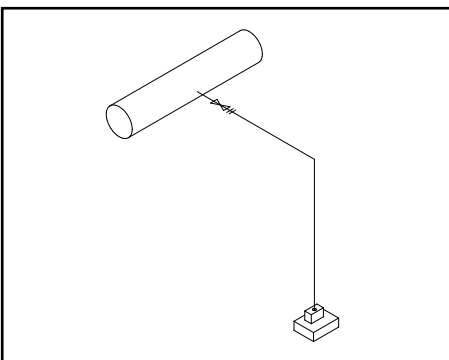

General Liquid Line Model

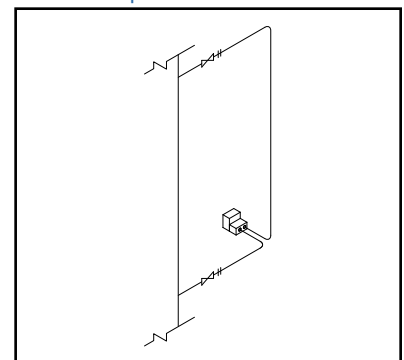

① Differential Pressure Transmitter

- Tube Fittings : **V-Lok** SERIES **P9**
- Union-Bonnet Needle valves : VUH-934P SERIES **P135**
- Ball Valves : VUBV SERIES **P105**
- Instrument Manifolds/Valves : VUT SERIES **P145**

② Pressure Transmitter

- Tube Fittings : **V-Lok** SERIES **P9**
- Union-Bonnet Needle valves : VUH-934P SERIES **P135**
- Ball Valves : VUBV SERIES **P105**
- Instrument Manifolds/Valves : VUT SERIES **P145**

③ Liquid Level Meter by Differential Pressure

- Tube Fittings : **V-Lok** SERIES **P9**
- Union-Bonnet Needle valves : VUH-934P SERIES **P135**
- Ball Valves : VUBV SERIES **P105**
- Instrument Manifolds/Valves : VUT SERIES **P145**

④ Sampling Line

- Tube Fittings : **V-Lok** SERIES **P9**
- Union-Bonnet Needle valves : VUH-934P SERIES **P135**
- Ball Valves : VUBV SERIES **P105**
- Bellows Valves : VUBF SERIES **P161**
- Check Valves : VUCL SERIES **P177**
- Plug Valves : VUP SERIES **P127**

⑤ Analyzing Equipment

- Tube Fittings : **V-Lok** SERIES **P9**
- Union-Bonnet Needle valves : VUH-934P SERIES **P135**
- Ball Valves : VUBV SERIES **P105**
- Bellows Valves : VUBF SERIES **P161**
- Check Valves : VUCL SERIES **P177**
- Plug Valves : VUP SERIES **P127**
- Afcon **P181**

⑥ Air Line

- Tube Fittings : **V-Lok** SERIES **P9**
- Tube Fittings : PDW **P85**
- Union-Bonnet Needle valves : VUH-934P SERIES **P135**
- PDS **P139**
- Ball Valves : VUBV SERIES **P105**

⑦ Steam Tracing Line

- Tube Fittings : **V-Lok** SERIES **P9**
- Tube Fittings : PDW **P85**
- Union-Bonnet Needle valves : VUH-934P SERIES **P135**
- PDS **P139**

⑧ Pilot Plant / Experiment Plant

- Tube Fittings : **V-Lok** SERIES **P9**
- Union-Bonnet Needle valves : VUH-934P SERIES **P135**
- Ball Valves : VUBV SERIES **P105**
- Bellows Valves : VUBF SERIES **P161**
- Check Valves : VUCL SERIES **P177**
- Plug Valves : VUP SERIES **P127**
- Afcon **P181**

⑨ NACE STANDARD Line

- Tube Fittings : **V-Lok** SERIES **P9**
- Union-Bonnet Needle valves : VUH-934P SERIES **P135**
- Ball Valves : VUBV SERIES **P105**
- Instrument Manifolds/Valves : VUT SERIES **P145**
- Bellows Valves : VUBF SERIES **P161**
- Check Valves : VUCL SERIES **P177**
- Toggle Valves : VUK **P169**
- Plug Valves : VUP SERIES **P127**
- Afcon **P181**

⑩ Differential Pressure Transmitter

- Tube Fittings : **V-Lok** SERIES **P9**
- Union-Bonnet Needle valves : VUH-934P SERIES **P135**
- Ball Valves : VUBV SERIES **P105**
- Instrument Manifolds/Valves : VUT SERIES **P145**

⑪ Pressure Transmitter

- Tube Fittings : **V-Lok** SERIES **P9**
- Union-Bonnet Needle valves : VUH-934P SERIES **P135**
- Ball Valves : VUBV SERIES **P105**
- Instrument Manifolds/Valves : VUT SERIES **P145**

⑫ Air Line

- Tube Fittings : **V-Lok** SERIES **P9**
- Tube Fittings : PDW **P85**
- Union-Bonnet Needle valves : VUH-934P SERIES **P135**
- PDS **P139**
- Ball Valves : VUBV SERIES **P105**



V-Lok Tube Fittings



PDW Tube Fittings



Ball Valves



3-Pieces Ball Valves



Trunnion Ball Valves



Plug Valves



Union-Bonnet Needle Valves



Integral-Bonnet Needle Stop Valves



Brass Needle Stop Valves



Instrument Manifolds / Gauge Valves



Bellows Valves



Toggle Valves



Relief Valves



Check Valves

Delivery Records

Process & Instrumentation Valve Equipment for Oil & Gas and General Industries



 **CHINA**
EO, EG PLANT
FGD PLANT

 **JAPAN**
ETHYLENE PLANT
REFINERY
COAL THERMAL
POWER PLANT
CHEMICAL GRADE
METHANOL PLANT
EO EG PLANT
POLYACETAL PLANT
PETROCHEMICAL PLANT

 **TAIWAN**
AROMATICS
TEREPHTHALIC ACID PLANT
PTA PLANT

 **VIETNAM**
REFINERY
COAL THERMAL
POWER PLANT
STEEL PLANT
BIOETHANOL PLANT

 **SINGAPORE**
PETROCHEMICAL PLANT
ETHYLENE PLANT
PTA PLANT
BISPHENOL PLANT

 **INDONESIA**
PETROCHEMICAL PLANT
SAP - CHEMICAL PLANT
SURFACTANT
- CHEMICAL PLANT

Fittings

V-Lok Tube Fittings Double Rings Compression and Bite Type Stainless Steel

PDW Tube Fittings Double Rings Compression and Bite Type Brass

Overview of V-Lok Tube Fittings

V-Lok is a high performance tube fitting that combines the sealing properties and quality control technologies required for power plant instrumentation fittings, other industries, and the ultra-pure construction required used in fittings used in semiconductor manufacturing equipment.

V-Lok is new value series that provides high performance, cost effectiveness, and quick delivery.

V-Lok tube fittings combine leading edge manufacturing technology and exceptional cost performance.

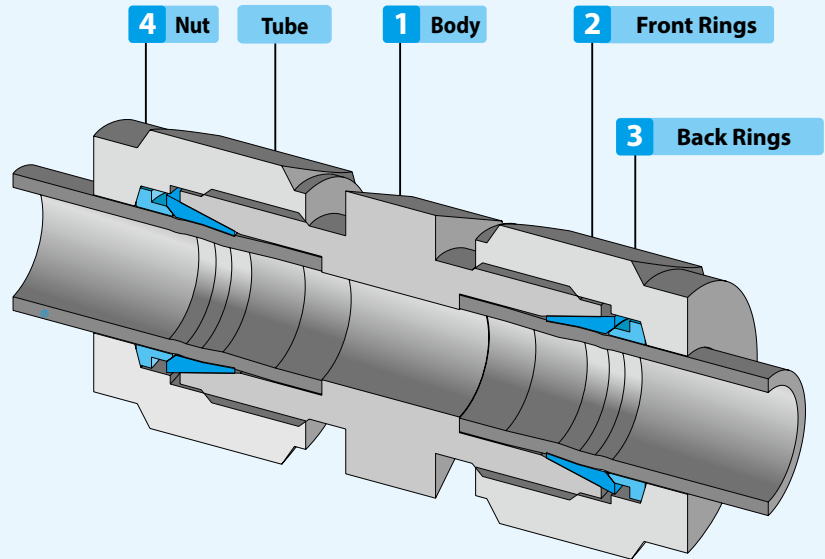
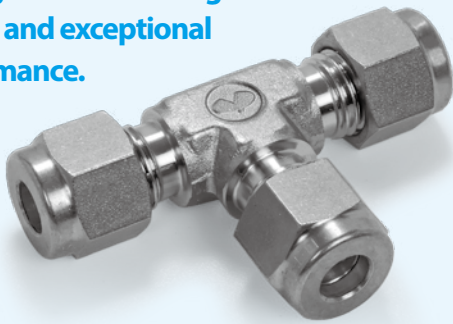

V-Lok Tube Fittings are composed of four parts:
1. Body 2. Front Rings 3. Back Rings 4. Nut

V-Lok How Does it Works?

The V-Lok Tube Fittings is a mechanism used both to seal and to grip tubing. The mechanical advantage and geometry of this kind of fitting produces a leak-tight assembly.

To assemble, simply insert the tube into the complete assembly until the tube bottoms-out against the shoulder of the fitting body (1). The two Rings are driven forward between the nut (4) and fitting body using the mechanical force created by rotating the nut clockwise. The back Rings (3) is driven against the tapered rear of the front Rings (2) and the front Rings is driven by force into the tapered mouth of the body.

The back Rings is swaged radially inwards on the tube while lifting the front Rings out to form a full-faced seal on the tapered surface of the body. The 1 1/4 turn of the nut from the hand tight position assures consistent drive of the sealing parts. This ensures an effective seal against high pressure as well as ultra high vacuum conditions.

V-Lok Installation Instructions

V-Lok fittings are supplied assembled and hand tight. Disassembly before use can allow the entry of dirt or other particles.

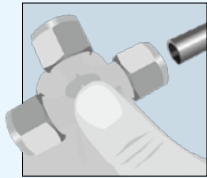

Insert the tubing completely into the V-Lok tube fittings.
Check that the tube point contacts with the fitting body shoulder and that the nut is hand tight until it cannot be tightened further. At this point it is recommended that a scribe mark be drawn on the hex of the nut extending onto the fitting body. This mark will serve as an indicator for the starting point and proper pull-up.

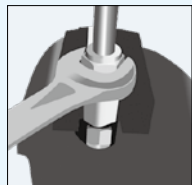

Tighten the nut.
1 1/4 turn of the nut are required for 1/4" (6 mm) and larger fittings (see Fig. A). 3/4 turn of the nut is required for 3/16" (4 mm) and smaller fittings (see Fig. B).
Plugs (part number: VUWJP) and port connectors (part number: VUW-PC): First tighten the nuts manually, and then use a wrench to tighten them a further 1/4 turn only for sizes of 6 mm or more, 1/8 turn only for sizes of 3/16 in. or less. Assembly is then complete.

Figure A

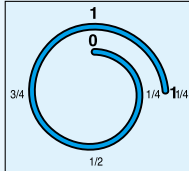
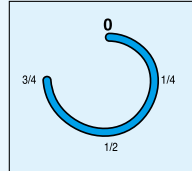

Figure B



Reassembly Instructions

V-Lok tube fittings may be disconnected and reconnected repeatedly, without loss of the leak-tight seal.

1. Before reassembling the parts, ensure that there is no foreign matter on the sealing diagonal face of the fitting body and the front Rings.
2. Insert the front Rings until it reaches the body, and then manually tighten the nut enough.
3. With a wrench, tighten the nut approximately 1/4 turn. Assembly is then complete.
4. Plugs (part number: VUWJP) and port connectors (part number: VUW-PC): First tighten the nuts manually, and then use a wrench to tighten them a further 1/4 turn only for sizes of 6 mm or more, 1/8 turn only for sizes of 3/16 in. or less. Assembly is then complete.

Note:

1. After reassembly, the fitting body and nut should return to their original position, or be tightened slightly further.
2. For fittings with nominal diameters between 1.6mm (1/16"OD) and 4.8mm, tighten the nut 1/6 turn.
3. For fittings with nominal diameters of 15.88mm (5/8"OD) or larger, it may occasionally be necessary to tighten the nut 1/4 turn or more.
4. Don't use the gap inspection gauge for reassembly.

Before Installation

1. Use an austenitic stainless steel tube with a seamless bright anneal finish, a hardness of Hv200 or less, and a tolerance within ± 0.1 mm of the tube O.D..
2. Please refer to "Tubing Data" on page 12 for recommended tube wall thickness.
3. There should be no visible scratches 30mm from either end of the tube. Remove any foreign matter.
4. Scratches on the tube may cause leaks. It is therefore important to handle the tube carefully to reduce the risk of leak. Please do not drag tube when taking out of the shelf and drag on the floor to avoid scratching on the tube.
5. Before assembling the fittings, cut the tubes to the required length.
6. Use a tube cutter to cut the tube. To attain a leak-free connection, the tubing must be cut squarely. A high-quality tube cutter with an appropriate blade for the tubing material is recommended.
If it is necessary to use a different method, for example hacksaw cut ting, be sure to cut the tube at a right angle, and then remove burrs carefully from the outer circumference by filing at a 45° angle to the center line.
7. Tube cutter blades should be replaced regularly to maintain sharpness.
8. Before tightening the fitting, ensure that the tube and the fitting are properly aligned.
9. Before tightening the fitting, ensure that its body has been secured using a wrench. Never hold the nut in place while attempting to tighten the body.

10. Carry out tube bending with a tube bender of the required size.
Refer to the following figure and the bending size shown in the right table.

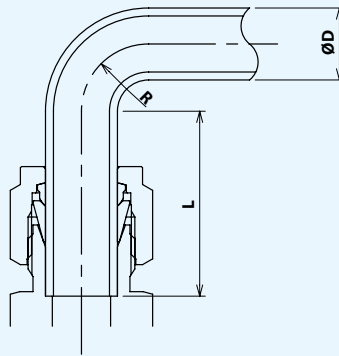

Attention!

A small amount of grease has been applied to the wetted area of this product. Please kindly contact **Fujikin**, if you require high cleaning level. We can recommend you F900 Tube Fittings(FINELOK·PURE), UJR Fittings, UPG® Fittings, etc. as an appropriate alternative product. We've surely checked the safety for this product in the condition of pressurized with Oxygen at 400°C. However, Improper handling with Oxygen gas system may result in a system failure or a serious fire accident. When using Oxygen gas with this product, you are kindly requested to take a proper handling for safety purpose on your own authority and responsibility.

Post-assembly: Inspection with a "No-Go" gauge (New Fittings Only)

1. Position the "No-Go" gauge next to the gap between the nut and body.
2. If the gauge cannot fit into the gap, the fitting is sufficiently tightened.
3. If the gauge can enter the gap, additional tightening is required.

Note: Do not use the "No-Go" gauge on retightened or pre-tightened fittings.

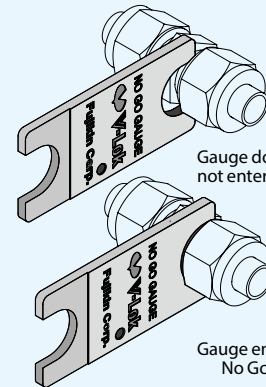

Ordering Information for the V-Lok "No-Go" gauge

Part No.	Fitting Size
G-VUW - 9.52 x 6.35	1/4", 6mm, 3/8", 8mm
G-VUW - 12.7 x 10	10mm, 1/2", 12mm

Tube bending size table

Unit: mm

Nominal Dia. (Tube O.D.)	Length of straight tube part		Bend Radius (Min.)	
	D	L		
mm	Inch	L1	L2	R
—	1/16	17	11	—
2.3	1/8	25	15	9.5
4	3/16	26	16	11.1
6	1/4	28	17	14.3
8	5/16	30	18	17.5
10	3/8	33	19.5	23.8
12	1/2	41	26	38.1
14, 15, 16	5/8	42	27	57.1
18, 20, 22	3/4, 7/8	44	27	76.2
25	1	52	33	88.9

L1: Length recommended by **Fujikin**.
L2: Length in the case where the minimum dimension is required.

Physical Differences and Marking

V-Lok Metric Fittings:

Tee & Elbow (see Fig. 1)

Body marked: MM

Straight Connectors: (see Fig. 2)

Body: Stepped shoulder
marked: F-CARP 316 AV⁽¹⁾

Nut: (see Figs.1 & 2) Stepped shoulder
marked: V-LOK 316 6M⁽²⁾ SD8⁽¹⁾

Fig. 1 Back side

V-LOK 316 6M SD8

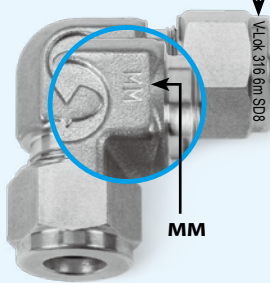

Fig. 1 Front side

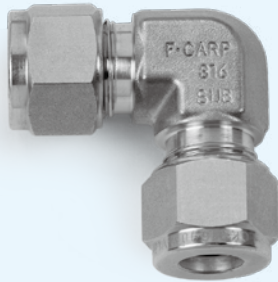
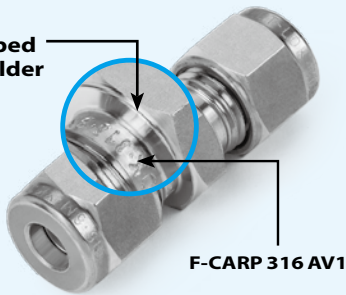

Fig. 2

Stepped
Shoulder



F-CARP 316 AV1

V-Lok INCH FITTINGS:

Tee & Elbow: (See Fig. 3)

Straight Fittings: (see Fig. 4)

Body: Shoulder marked:

F-CARP 316 AV2⁽¹⁾

Nut: (See Fig. 3 & 4): Shoulder
marked V-LOK 316 1/2⁽²⁾ BU2⁽¹⁾

(1): Material Batch

(2): Tube O.D.

Fig. 3 Back side

V-LOK 316 1/2 BU2

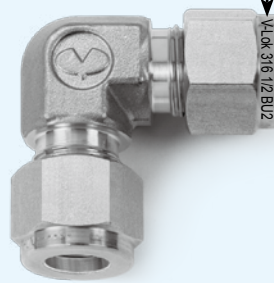

Fig. 3 Front side

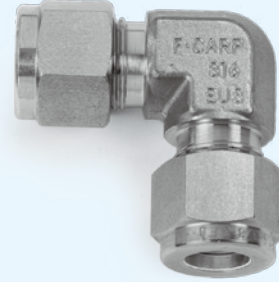

Fig. 4



F-CARP 316 AV2

V-Lok Tubing Data

Table 1-1 Maximum Allowable Working Pressure Of Stainless Steel Each Tube Wall Thickness (Inch Size)

Tube Wall Thickness	0.010	0.012	0.014	0.016	0.020	0.028	0.035	0.049	0.065	0.083	0.095	0.109	0.120
Nom. Dia. (Inch)	Maximum Allowable Working Pressure (psig)												
1/16	5590	6860	8130	9450	12060								
1/8						8540	10950						
3/16						5490	7090	10290					
1/4						4090	5190	7590	10290				
5/16							4090	5880	8090				
3/8							3350	4840	6540				
1/2							2630	3740	5140	6740			
5/8								2940	4040	5250	6040		
3/4								2430	3350	4240	4940	5840	
7/8								2040	2840	3640	4240	4840	
1									2390	3080	3590	4190	4690

(UNIT : psig)

Table 1-2 Maximum Allowable Working Pressure Of Stainless Steel Each Tube Wall Thickness (mm Size)

Tube Wall Thickness	0.028	0.031	0.039	0.047	0.059	0.071	0.079	0.087	0.098	0.11	0.118
Nom. Dia. (mm)	Maximum Allowable Working Pressure (psig)										
2	7540	10870									
3		9710									
4		6960	9570								
6		4490	6090	7830	10290						
8			4490	5650	7540	8090					
10			3480	4350	5800	7390					
12			2900	3620	4780	5940	6810				
14			2320	2900	3910	4930	5510	6230			
15			2170	2750	3620	4490	5220	5800			
16				2460	3330	4200	4780	5360	5800		
18				2170	2900	3770	4200	4640	5360		
20				2030	2610	3330	3770	4200	4780	5510	
22				1740	2320	2900	3330	3770	4350	4930	
25						2610	2900	3330	3770	4200	4640

Table 2: Factors Used To Determine Allowable Working Pressure At Higher Temperature

°F	°C	A.I.S.I. 316
200	93	1
400	204	0.96
600	316	0.85
800	427	0.79
1000	538	0.76
1200	649	0.37

To determine allowable pressure at higher temperatures, multiply allowable working pressure from Tables 1 by factors shown in Table 2. For example: The allowable pressure for Type 316 stainless steel, size 1/2" O.D. x 0.049" wall at 800°F(427°C) would be equivalent to 3750 psi x 0.79 = 2962.5 psi. Regarding Min. Nominal Wall Thickness, please refer to Table 3.

Table 3: Gas Application Tubing

in		mm	
Tube O.D.	Min. Nominal Wall Thickness	Tube O.D.	Min. Nominal Wall Thickness
1/8" (3.17mm)	0.028" (0.7mm)	3 mm	0.8 mm
3/16" (4.76mm)	0.028" (0.7mm)	6 mm	0.8 mm
1/4" (6.35mm)	0.028" (0.7mm)	8 mm	1 mm
5/16" (7.93mm)	0.035" (0.89mm)	10 mm	1 mm
3/8" (9.52mm)	0.035" (0.89mm)	12 mm	1 mm
1/2" (12.7mm)	0.049" (1.24mm)	14 mm	1.2 mm
5/8" (15.87mm)	0.065" (1.65mm)	16 mm	1.5 mm
3/4" (19.05mm)	0.065" (1.65mm)	18 mm	1.5 mm
7/8" (22.22mm)	0.083" (2.1mm)	20 mm	1.8 mm
1" (25.4mm)	0.083" (2.1mm)	22 mm	2 mm
		25 mm	2.2 mm

For gas applications, we recommend tubing with a greater wall thickness. Table 3 shows the recommended min.wall thicknesses for greater safety and efficiency.

- Attention!**
- The value of Table 1 is a maximum allowable working pressure calculated from the tube thickness. The maximum allowable working pressure of the fitting is limited from the value of this table according to the application regulations, and use it, please after considering the application regulations and the standard of used equipment.
 - There is a possibility that the seal decreases remarkably, and consult separately, please when it is used for a long time exceeding 400°C.























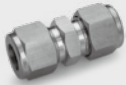

Applicable Fluid

Air, Nitrogen gas, Inert gas like Helium, and non - corrosive gas and liquid.

V-Lok Part Number Designation

All orders should include material description and ordering information (See product table).

V	U	W	H	6.35	B
Product Series	Material	Type of Tube Fittings	Connector Type	Nominal Diameter	Thread Size
	Stainless Steel	Double Rings Compression and Bite Type	Male Connector	Outer Diameter of Tube	R1/4

V-Lok Index					
Front Rings 15 S 	Tube Fittings to Female Thread Connectors (NPT) 24, 25 G 	Male Connectors (G) 40 H 			
Back Rings 15 R 	Tube Fittings to Female Thread Connectors (Rc) 26, 27 G 	Male Connectors (UNF) 41 H 			
Inserts For Soft Plastic Tubing ... 16 IN 	Tube Fittings to Female Thread Connectors (G) 28 G 	Male Connectors (NPT) 42 H 			
Nuts 16 N 	Reducers 29, 30, 31 R 	Male Connectors (UNF) 42 H 			
Unions 17 F 	Port Connectors 32 PC 	Male Pipe Weld Connectors ... 43 R 			
Reducing Unions 18, 19 F 	Reducing Port Connectors 33 PC 	Tube Socket Weld Unions 44 R 			
Union Tees 20 T 	Male Connectors (NPT) 34, 35 H 	Flange Unions 44 RF 			
Reducing Union Tees 21, 22 T 	Male Connectors (R) 36, 37 H 				
Union Elbows 23 L 	Male Connectors (G) 38, 39 H 				

V-Lok Index		
Male Elbows (NPT).....45, 46 L 	Male Branch Tees (R).....57 TS 	Plugs.....66 JP 
Male Elbows (R).....47, 48 L 	Female Branch Tees (NPT).....58 TG 	Female Tube Adapters (NPT).....67, 68 GA 
Male Pipe Weld Elbows.....49 LR 	Female Branch Tees (Rc).....59 TG 	Female Tube Adapters (Rc).....69, 70 GA 
Tube Socket Weld Elbows.....49 LR 	Bulkhead Unions.....60 P 	Male Tube Adapters (NPT).....71, 72 A 
Female Elbows (NPT).....50 LG 	Bulkhead Female Connectors (NPT).....61 GP 	Male Tube Adapters (R).....73, 74 A 
Female Elbows (Rc).....51 LG 	Bulkhead Female Connectors (Rc).....61 GP 	Male Nuts.....75 
Male Run Tees (NPT).....52 TL 	Bulkhead Reducers.....61 RP 	Unions For Chromatograph...75 
Male Run Tees (R).....53 TL 	Bulkhead Male Connectors (NPT).....62 HP 	Reducing Unions For Chromatograph.....75 
Female Run Tees (NPT).....54 TLG 	Bulkhead Male Connectors (R).....63 HP 	Union Tees For Chromatograph.....75 
Female Run Tees (Rc).....55 TLG 	Union Crosses.....64 X 	Male Positionable Branch Tees Male Positionable Elbows...76,77 
Male Branch Tees (NPT).....56 TS 	Caps.....65 JC 	Mounting Dimensions.....78 ISO Parallel Thread.....79,80,81 Stop Collar.....82 Pipe Fittings, Adapters.....83,84 UJB,UJS,UJN

Front Rings

S

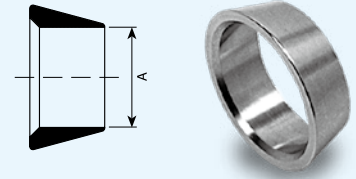

Metric		Inch		
Part Numbers	A Tube O.D.	Part Numbers	A Tube O.D.	
	mm		in	mm
VUW-2S	2	VUW-1.6S	1/16	1.6
VUW-3S	3	VUW-3.2S	1/8	3.2
VUW-4S	4	VUW-4.8S	3/16	4.8
VUW-6S	6	VUW-6.35S	1/4	6.35
VUW-8S	8	VUW-7.93S	5/16	7.93
VUW-10S	10	VUW-9.52S	3/8	9.52
VUW-12S	12	VUW-12.7S	1/2	12.7
VUW-14S	14	VUW-15.88S	5/8	15.88
VUW-15S	15	VUW-19.05S	3/4	19.05
VUW-16S	16	VUW-22.22S	7/8	22.22
VUW-18S	18	VUW-25.4S	1	25.4
VUW-20S	20			
VUW-22S	22			
VUW-25S	25			

Rings Sets

All V-Lok Rings are available as sets.

Back Rings

R

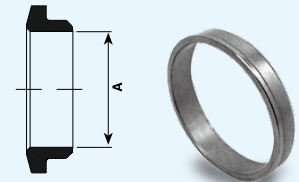

Metric		Inch		
Part Numbers	A Tube O.D.	Part Numbers	A Tube O.D.	
	mm		in	mm
VUW-2R	2	VUW-1.6R	1/16	1.6
VUW-3R	3	VUW-3.2R	1/8	3.2
VUW-4R	4	VUW-4.8R	3/16	4.8
VUW-6R	6	VUW-6.35R	1/4	6.35
VUW-8R	8	VUW-7.93R	5/16	7.93
VUW-10R	10	VUW-9.52R	3/8	9.52
VUW-12R	12	VUW-12.7R	1/2	12.7
VUW-14R	14	VUW-15.88R	5/8	15.88
VUW-15R	15	VUW-19.05R	3/4	19.05
VUW-16R	16	VUW-22.22R	7/8	22.22
VUW-18R	18	VUW-25.4R	1	25.4
VUW-20R	20			
VUW-22R	22			
VUW-25R	25			

Rings Sets

All V-Lok Rings are available as sets.

Tube Inserts

IN

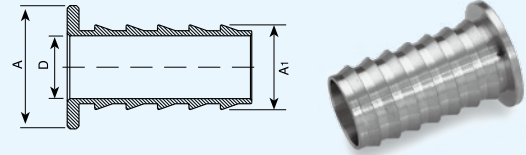

Metric			
Part Numbers	A Tube O.D.	A1 Tube I.D.	D
	mm	mm	mm
VUW-IN-6X4	6	4	2.8
VUW-IN-8X6	8	6	4.4
VUW-IN-10X8	10	8	6.4
VUW-IN-12X8-19	12	8	6.4
VUW-IN-12X10	12	10	8.3

Inch						
Part Numbers	A Tube O.D.		A1 Tube I.D.		D	
	in	mm	in	mm	in	mm
VUW-IN-4.8X3.2	3/16	4.8	1/8	3.2	0.09	2.3
VUW-IN-6.35X3.2	1/4	6.35	1/8	3.2	0.09	2.3
VUW-IN-6.35X4.3	1/4	6.35	0.17	4.3	0.11	2.7
VUW-IN-6.35X4.8	1/4	6.35	3/16	4.8	0.12	3.1
VUW-IN-7.93X3.2	5/16	7.93	1/8	3.2	0.09	2.3
VUW-IN-7.93X4.8	5/16	7.93	3/16	4.8	0.12	3
VUW-IN-7.93X6.35	5/16	7.93	1/4	6.35	0.18	4.6
VUW-IN-9.52X4.8	3/8	9.52	3/16	4.8	0.12	3.1
VUW-IN-9.52X6.35	3/8	9.52	1/4	6.35	0.18	4.6
VUW-IN-12.7X6.35	1/2	12.7	1/4	6.35	0.18	4.6
VUW-IN-12.7X9.52	1/2	12.7	3/8	9.52	0.31	7.8
VUW-IN-15.88X9.52	5/8	15.88	3/8	9.52	0.31	7.8
VUW-IN-15.88X12.7	5/8	15.88	1/2	12.7	0.44	11.1
VUW-IN-19.05X12.7	3/4	19.05	1/2	12.7	0.44	11.1
VUW-IN-19.05X15.88	3/4	19.05	5/8	15.88	0.56	14.2
VUW-IN-25.4X19.05	1	25.4	3/4	19.05	0.69	17.5

Nuts

N

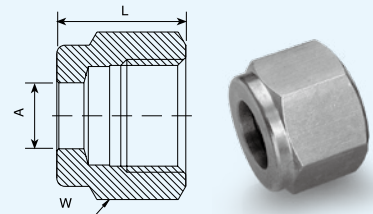

Metric			
Part Numbers	A Tube O.D.	W	L
	mm	mm	mm
VUW-2N	2	12	11.9
VUW-3N	3	12	11.9
VUW-4N	4	12	12
VUW-6N	6	14	12.7
VUW-8N	8	16	13.5
VUW-10N	10	19	15.1
VUW-12N	12	22	17.4
VUW-14N	14	25	17.4
VUW-15N	15	25	17.4
VUW-16N	16	25	17.4
VUW-18N	18	30	17.4
VUW-20N	20	32	17.4
VUW-22N	22	32	17.4
VUW-25N	25	38	20.6

Inch						
Part Numbers	A Tube O.D.		W		L	
	in	mm	in	mm	in	mm
VUW-1.6N	1/16	1.6	5/16	7.9	0.31	8
VUW-3.2N	1/8	3.2	7/16	11.1	0.47	11.9
VUW-4.8N	3/16	4.8	1/2	12.7	0.47	11.9
VUW-6.35N	1/4	6.35	9/16	14.3	0.5	12.7
VUW-7.93N	5/16	7.93	5/8	15.9	0.53	13.5
VUW-9.52N	3/8	9.52	11/16	17.5	0.56	14.3
VUW-12.7N	1/2	12.7	7/8	22.2	0.69	17.5
VUW-15.88N	5/8	15.88	1	25.4	0.69	17.5
VUW-19.05N	3/4	19.05	1 1/8	28.6	0.69	17.5
VUW-22.22N	7/8	22.22	1 1/4	31.8	0.69	17.5
VUW-25.4N	1	25.4	1 1/2	38.1	0.81	20.6

"D" - Dimension is minimum hole diameter - dimensions are for reference only, and are subject to change without notice.

Unions

F

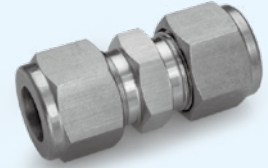
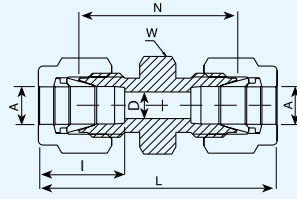

Tube (Metric) To Tube (Metric)

Part Numbers	A Tube O.D.		D		W		N		L		I	
	mm	mm	mm	mm	mm	mm	mm	mm	mm	mm	mm	mm
VUWF-2	2		1.7		12		22.4		35.6		12.9	
VUWF-3	3		2.4		12		22.1		35.3		12.9	
VUWF-4	4		2.4		12		24.1		37.3		13.7	
VUWF-6	6		4.8		14		26.2		41		15.3	
VUWF-8	8		6.4		15		28.2		43.2		16.2	
VUWF-10	10		7.9		18		31		46.2		17.2	
VUWF-12	12		9.5		22		31		51.2		22.8	
VUWF-14	14		11		24		31.8		52		22.8	
VUWF-15	15		12		24		31.8		52		24.4	
VUWF-16	16		12.7		24		31.8		52		24.4	
VUWF-18	18		15.1		27		33.3		53.5		24.4	
VUWF-20	20		15.9		30		34.8		55		26	
VUWF-22	22		18.3		30		34.8		55		26	
VUWF-25	25		21.8		35		40.4		65		31.3	

Tube (Inch) To Tube (Inch)

Part Numbers	A Tube O.D.		D		W		N		L		I	
	in	mm	in	mm	in	mm	in	mm	in	mm	in	mm
VUWF-1.6	1/16	1.6	0.05	1.3	5/16	7.9	0.69	17.5	0.99	25.2	0.34	8.6
VUWF-3.2	1/8	3.2	0.09	2.3	7/16	11.1	0.88	22.4	1.4	35.6	0.5	12.7
VUWF-4.8	3/16	4.8	0.12	3.1	7/16	11.1	0.95	24.1	1.47	37.3	0.54	13.7
VUWF-6.35	1/4	6.35	0.19	4.8	1/2	12.7	1.03	26.2	1.61	40.9	0.6	15.2
VUWF-7.93	5/16	7.93	0.25	6.4	9/16	14.3	1.11	28.2	1.69	42.9	0.64	16.3
VUWF-9.52	3/8	9.52	0.28	7.1	5/8	15.9	1.19	30.2	1.77	45	0.66	16.8
VUWF-12.7	1/2	12.7	0.41	10.4	13/16	20.6	1.22	31	2.02	51.3	0.9	22.9
VUWF-15.88	5/8	15.88	0.5	12.7	15/16	23.8	1.25	31.8	2.05	52.1	0.96	24.4
VUWF-19.05	3/4	19.05	0.62	15.8	1 1/16	27	1.31	33.3	2.11	53.6	0.96	24.4
VUWF-22.22	7/8	22.22	0.72	18.3	1 3/16	30.2	1.38	35.1	2.17	55.1	1.02	25.9
VUWF-25.4	1	25.4	0.88	22.3	1 3/8	34.9	1.59	40.4	2.55	64.8	1.23	31.2

"D" - Dimension is minimum hole diameter - dimensions are for reference only, and are subject to change without notice.

Reducing Unions

F

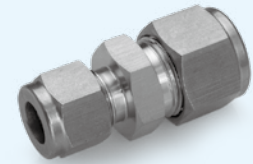
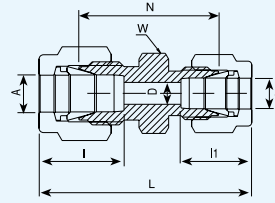

Tube (Metric) To Tube (Metric)

Part Numbers	A	A1	D	W	N	L	I	I1
	Tube O.D.	Tube O.D.	mm	mm	mm	mm	mm	mm
VUWF-3X2	3	2	1.7	12	22.1	35.3	12.9	12.9
VUWF-6X2	6	2	1.7	14	24.6	38.6	15.3	12.9
VUWF-6X3	6	3	2.3	14	24.6	38.6	15.3	12.9
VUWF-6X4	6	4	2.3	14	25.4	39.4	15.3	13.7
VUWF-8X6	8	6	4.8	15	27.4	42.3	16.2	15.3
VUWF-10X6	10	6	4.8	18	29.5	44.5	17.2	15.3
VUWF-10X8	10	8	6.4	18	30	45.1	17.2	16.2
VUWF-12X6	12	6	4.8	22	29.5	47	22.8	15.3
VUWF-12X8	12	8	6.4	22	30.2	47.8	22.8	16.2
VUWF-12X10	12	10	7.9	22	31	48.7	22.8	17.2
VUWF-16X10	16	10	7.9	24	31.8	49.5	24.4	17.2
VUWF-16X12	16	12	9.5	24	31.8	52	24.4	22.8
VUWF-18X12	18	12	9.5	27	33.3	53.5	24.4	22.8
VUWF-25X18	25	18	15.1	35	38.6	61	31.3	24.4
VUWF-25X20	25	20	15.9	35	39.9	62.3	31.3	26

Tube (Metric) To Tube (Inch)

Part Numbers	A	A1	D	W	N	L	I	I1
	Tube O.D.	Tube O.D.	mm	mm	mm	mm	mm	mm
VUWF-6.35X2	2	1/4	1.7	14	24	38.6	12.9	15.2
VUWF-3.2X3	3	1/8	2.3	12	22.1	35.2	12.9	12.7
VUWF-4X3.2	4	1/8	2.4	12	23.4	36.5	13.7	12.7
VUWF-6.35X4	4	1/4	2.4	14	25.4	39.4	13.7	15.2
VUWF-6X3.2	6	1/8	2.4	14	24.6	38.5	15.3	12.7
VUWF-6.35X6	6	1/4	4.8	14	26.2	41	15.3	15.2
VUWF-7.93X6	6	5/16	4.8	14	27.4	42.3	15.3	16.2
VUWF-8X3.2	8	1/8	2.4	15	25.9	39.9	16.2	12.7
VUWF-8X6.35	8	1/4	4.8	15	27.4	42.3	16.2	15.2
VUWF-9.52X8	8	3/8	6.4	16	29.5	44.3	16.2	16.8
VUWF-10X3.2	10	1/8	2.4	18	27.7	41.8	17.2	12.7
VUWF-10X6.35	10	1/4	4.8	18	29.5	44.5	17.2	15.2
VUWF-10X7.93	10	5/16	6.4	18	30	45.1	17.2	16.2
VUWF-10X9.52	10	3/8	7.1	18	31	46	17.2	16.8
VUWF-12X7.93	12	5/16	6.4	22	30.2	47.8	22.8	16.2
VUWF-12X9.52	12	3/8	7.1	22	31	48.4	22.8	16.8
VUWF-12.7X12	12	1/2	9.5	22	31	51.2	22.8	22.9
VUWF-15X12.7	15	1/2	10.4	24	31.8	52.1	24.4	22.9
VUWF-16X15.88	16	5/8	12.7	24	31.8	52	24.4	24.4
VUWF-19.05X18	18	3/4	15.1	27	33.3	53.5	24.4	24.4

"D" - Dimension is minimum hole diameter - dimensions are for reference only, and are subject to change without notice.

Reducing Unions (continued)

F

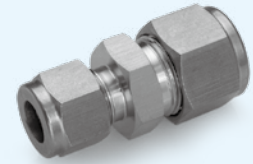
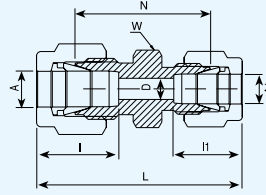

Tube (Inch) To Tube (Inch)

Part Numbers	A Tube O.D.		A1 Tube O.D.		D		W		N		L		I		I1	
	in	mm	in	mm	in	mm	in	mm	in	mm	in	mm	in	mm	in	mm
VUWF-3.2X1.6	1/8	3.2	1/16	1.6	0.05	1.3	7/16	11.1	0.81	20.6	1.22	31	0.5	12.7	0.34	8.6
VUWF-4.8X1.6	3/16	4.8	1/16	1.6	0.05	1.3	7/16	11.1	0.86	21.8	1.27	32.3	0.54	13.7	0.34	8.6
VUWF-4.8X3.2	3/16	4.8	1/8	3.2	0.09	2.3	7/16	11.1	0.92	23.4	1.44	36.6	0.54	13.7	0.5	12.7
VUWF-6.35X1.6	1/4	6.35	1/16	1.6	0.05	1.3	1/2	12.7	0.91	23.1	1.35	34.3	0.6	15.2	0.34	8.6
VUWF-6.35X3.2	1/4	6.35	1/8	3.2	0.09	2.3	1/2	12.7	0.97	24.6	1.52	38.6	0.6	15.2	0.5	12.7
VUWF-6.35X4.8	1/4	6.35	3/16	4.8	0.12	3.1	1/2	12.7	1	25.4	1.55	39.4	0.6	15.2	0.54	13.7
VUWF-7.93X3.2	5/16	7.93	1/8	3.2	0.09	2.3	9/16	14.3	1.01	25.7	1.56	39.6	0.64	16.3	0.5	12.7
VUWF-7.93X6.35	5/16	7.93	1/4	6.35	0.19	4.8	9/16	14.3	1.08	27.4	1.66	42.2	0.64	16.3	0.6	15.2
VUWF-9.52X1.6	3/8	9.52	1/16	1.6	0.05	1.3	5/8	15.9	1	25.4	1.44	36.6	0.66	16.8	0.34	8.6
VUWF-9.52X3.2	3/8	9.52	1/8	3.2	0.09	2.3	5/8	15.9	1.06	26.9	1.61	40.9	0.66	16.8	0.5	12.7
VUWF-9.52X6.35	3/8	9.52	1/4	6.35	0.19	4.8	5/8	15.9	1.12	28.5	1.7	43.2	0.66	16.8	0.6	15.2
VUWF-9.52X7.93	3/8	9.52	5/16	7.93	0.25	6.35	5/8	15.9	1.16	29.5	1.74	44.2	0.66	16.8	0.64	16.3
VUWF-12.7X3.2	1/2	12.7	1/8	3.2	0.09	2.3	13/16	20.6	1.12	28.4	1.78	45.2	0.9	22.9	0.5	12.7
VUWF-12.7X6.35	1/2	12.7	1/4	6.35	0.19	4.8	13/16	20.6	1.16	29.5	1.85	47	0.9	22.9	0.6	15.2
VUWF-12.7X9.52	1/2	12.7	3/8	9.52	0.28	7.1	13/16	20.6	1.22	31	1.91	48.5	0.9	22.9	0.66	16.8
VUWF-15.88X9.52	5/8	15.88	3/8	9.52	0.28	7.1	15/16	23.8	1.25	31.8	1.94	49.3	0.96	24.4	0.66	16.8
VUWF-15.88X12.7	5/8	15.88	1/2	12.7	0.41	10.4	15/16	23.8	1.25	31.8	2.05	52.1	0.96	24.4	0.9	22.9
VUWF-19.05X6.35	3/4	19.05	1/4	6.35	0.19	4.8	1 1/16	27	1.25	31.8	1.94	49.3	0.96	24.4	0.6	15.2
VUWF-19.05X9.52	3/4	19.05	3/8	9.52	0.28	7.1	1 1/16	27	1.31	33.3	2	50.8	0.96	24.4	0.66	16.8
VUWF-19.05X12.7	3/4	19.05	1/2	12.7	0.41	10.4	1 1/16	27	1.31	33.3	2.11	53.6	0.96	24.4	0.9	22.9
VUWF-19.05X15.88	3/4	19.05	5/8	15.88	0.5	12.7	1 1/16	27	1.31	33.3	2.11	53.6	0.96	24.4	0.96	24.4
VUWF-25.4X12.7	1	25.4	1/2	12.7	0.41	10.4	1 3/8	34.9	1.5	38.1	2.38	60.5	1.23	31.2	0.9	22.9
VUWF-25.4X19.05	1	25.4	3/4	19.05	0.62	15.8	1 3/8	34.9	1.5	38.1	2.38	60.5	1.23	31.2	0.96	24.4

"D" - Dimension is minimum hole diameter - dimensions are for reference only, and are subject to change without notice.

Union Tees

T

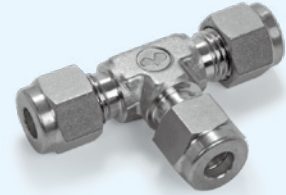
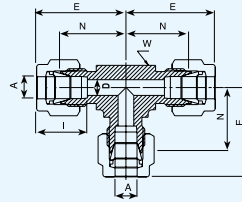

All Tube (Metric)

Part Numbers	A Tube O.D.		D		W		N		E		I	
	mm	mm	mm	mm	in	mm	mm	mm	mm	mm	mm	mm
VUWT-2	2		1.7		3/8	9.5		15.7		22.3		12.9
VUWT-3	3		2.4		3/8	9.5		15.7		22.3		12.9
VUWT-4	4		2.4		1/2	12.7		18.8		25.4		13.7
VUWT-6	6		4.8		1/2	12.7		19.6		27		15.3
VUWT-8	8		6.4		5/8	15.9		22.4		29.9		16.2
VUWT-10	10		7.9		11/16	17.5		23.9		31.5		17.2
VUWT-12	12		9.5		13/16	20.6		25.9		36		22.8
VUWT-14	14		11		15/16	23.8		28.7		38.8		24.4
VUWT-15	15		12		15/16	23.8		28.7		38.8		24.4
VUWT-16	16		12.7		15/16	23.8		28.7		38.8		24.4
VUWT-18	18		15.1		1 1/16	27		29.7		39.8		24.4
VUWT-20	20		15.9		1 3/8	34.9		34.5		44.6		26
VUWT-22	22		18.3		1 3/8	34.9		34.5		44.6		26
VUWT-25	25		21.8		1 3/8	34.9		36.8		49.1		31.3

All Tube (Inch)

Part Numbers	A Tube O.D.		D		W		N		E		I	
	in	mm	in	mm	in	mm	in	mm	in	mm	in	mm
VUWT-1.6	1/16	1.6	0.05	1.3	3/8	9.5	0.55	14	0.7	17.8	0.34	8.6
VUWT-3.2	1/8	3.2	0.09	2.3	3/8	9.5	0.62	15.8	0.88	22.4	0.5	12.7
VUWT-4.8	3/16	4.8	0.12	3	1/2	12.7	0.7	17.8	0.96	24.4	0.54	13.7
VUWT-6.35	1/4	6.35	0.19	4.8	1/2	12.7	0.77	19.6	1.06	26.9	0.6	15.2
VUWT-7.93	5/16	7.93	0.25	6.4	5/8	15.9	0.88	22.4	1.17	29.7	0.64	16.3
VUWT-9.52	3/8	9.52	0.28	7.1	5/8	15.9	0.91	23.1	1.2	30.5	0.66	16.8
VUWT-12.7	1/2	12.7	0.41	10.4	13/16	20.6	1.02	25.9	1.42	36.1	0.9	22.9
VUWT-15.88	5/8	15.88	0.5	12.7	15/16	23.8	1.13	28.7	1.53	38.9	0.96	24.4
VUWT-19.05	3/4	19.05	0.62	15.8	1 1/16	27	1.17	29.7	1.57	39.9	0.96	24.4
VUWT-22.22	7/8	22.22	0.72	18.3	1 3/8	34.9	1.36	34.54	1.76	44.7	1.02	25.9
VUWT-25.4	1	25.4	0.88	22.3	1 3/8	34.9	1.45	36.8	1.93	49	1.23	31.2

"D" - Dimension is minimum hole diameter - dimensions are for reference only, and are subject to change without notice.

Reducing Union Tees

T

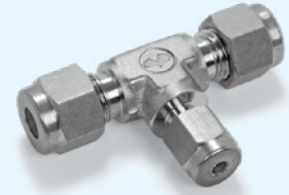

Tube (Inch) To Tube (Inch)

Part Numbers	A Tube O.D.		A1 Tube O.D.		E		E1		I		I1		D		W		N		N1	
	in	mm	in	mm	in	mm	in	mm	in	mm	in	mm	in	mm	in	mm	in	mm	in	mm
VUWT-9.52X9.52X6.35	3/8	9.52	1/4	6.35	1.2	30.5	1.14	29	0.66	16.8	0.6	15.2	0.19	4.8	5/8	15.9	0.91	23.1	0.85	21.6
VUWT-12.7X12.7X6.35	1/2	12.7	1/4	6.35	1.42	36.1	1.25	31.8	0.9	22.9	0.6	15.2	0.19	4.8	13/16	20.6	1.02	25.9	0.96	24.4
VUWT-12.7X12.7X9.52	1/2	12.7	3/8	9.52	1.42	36.1	1.31	33.3	0.9	22.9	0.66	16.8	0.28	7.1	13/16	20.6	1.02	25.9	1.02	25.9
VUWT-15.88X15.88X9.52	5/8	15.88	3/8	9.52	1.53	38.9	1.42	36.1	0.96	24.4	0.66	16.8	0.28	7.1	15/16	23.8	1.13	28.7	1.13	28.7
VUWT-19.05X19.05X9.52	3/4	19.05	3/8	9.52	1.57	39.9	1.46	37.1	0.96	24.4	0.66	16.8	0.28	7.1	1 1/16	27	1.17	29.7	1.17	29.7
VUWT-19.05X19.05X12.7	3/4	19.05	1/2	12.7	1.57	39.9	1.57	39.9	0.96	24.4	0.9	22.9	0.41	10.4	1 1/16	27	1.17	29.7	1.17	29.7
VUWT-25.4X25.4X9.52	1	25.4	3/8	9.52	1.93	49	1.65	41.9	1.23	31.2	0.66	16.8	0.28	7.1	1 3/8	34.9	1.45	36.8	1.36	34.5
VUWT-25.4X25.4X12.7	1	25.4	1/2	12.7	1.93	49	1.76	44.7	1.23	31.2	0.9	22.9	0.41	10.4	1 3/8	34.9	1.45	36.8	1.36	34.5
VUWT-25.4X25.4X19.05	1	25.4	3/4	19.05	1.93	49	1.76	44.7	1.23	31.2	0.96	24.4	0.62	15.8	1 3/8	34.9	1.45	36.8	1.36	34.5

V-Lok Tube Fittings Reducing Union Tees

How To Order

A A A1
 VUWT - 9.52 x 9.52 x 6.35

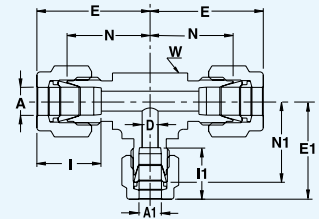
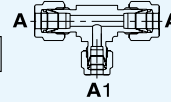

Reducing Union Tees

T

Tube (Inch) To Tube (Inch)

Part Number	A Tube O.D.		A1 Tube O.D.		E		E1		I		I1		D		W		N		N1	
	in	mm	in	mm	in	mm	in	mm	in	mm	in	mm	in	mm	in	mm	in	mm	in	mm
VUWT-9.52X6.35X9.52	3/8	9.52	1/4	6.35	1.2	30.5	1.14	29	0.66	16.8	0.6	15.2	0.19	4.8	5/8	15.9	0.91	23.1	0.85	21.6

How To Order

A A1 A
 VUWT - 9.52 x 6.35 x 9.52

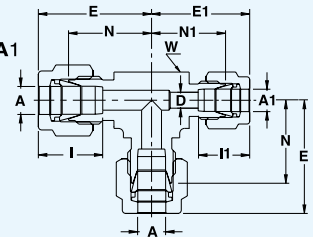
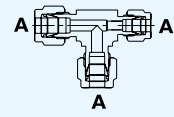

Cont'd on next page

"D" - Dimension is minimum hole diameter - dimensions are for reference only, and are subject to change without notice.

Reducing Union Tees (continued)

T

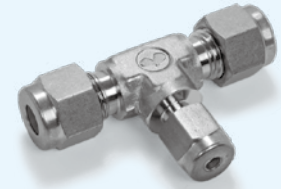

Tube (Inch) To Tube (Inch)

Part Numbers	A Tube O.D.		A1 Tube O.D.		E		E1		I		I1		D		W		N		N1	
	in	mm	in	mm	in	mm	in	mm	in	mm	in	mm	in	mm	in	mm	in	mm	in	mm
VUWT-12.7X9.52X9.52	1/2	12.7	3/8	9.52	1.42	36.1	1.31	33.3	0.9	22.9	0.66	16.8	0.28	7.1	13/16	20.6	1.02	25.9	1.02	25.9
VUWT-15.88X9.52X9.52	5/8	15.88	3/8	9.52	1.53	38.9	1.42	36.1	0.96	24.4	0.66	16.8	0.28	7.1	15/16	23.8	1.13	28.7	1.13	28.7
VUWT-19.05X9.52X9.52	3/4	19.05	3/8	9.52	1.57	39.9	1.46	37.1	0.96	24.4	0.66	16.8	0.28	7.1	1 1/8	28.6	1.17	29.7	1.17	29.7

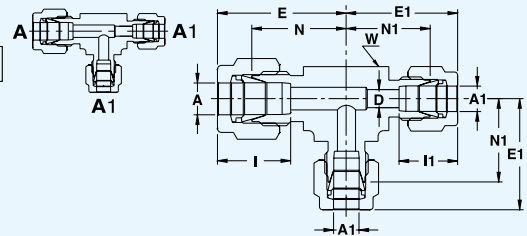
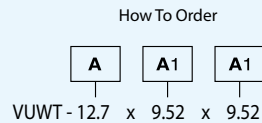

Reducing Union Tees (continued)

T

Tube (Inch) To Tube (Inch)

Part Numbers	A Tube O.D.		A1 Tube O.D.		A2 Tube O.D.		E		E1		E2		I		I1		I2		D		W		N		N1	
	in	mm	in	mm	in	mm	in	mm	in	mm	in	mm	in	mm	in	mm	in	mm	in	mm	in	mm	in	mm	in	mm
VUWT-15.88X12.7X9.52	5/8	15.88	1/2	12.7	3/8	9.52	1.53	38.9	1.53	38.9	1.42	36.1	0.96	24.4	0.9	22.9	0.66	16.8	0.28	7.1	15/16	23.8	1.13	28.7	1.13	28.7
VUWT-19.05X12.7X9.52	3/4	19.05	1/2	12.7	3/8	9.52	1.57	39.9	1.57	39.9	1.46	37.1	0.96	24.4	0.9	22.9	0.66	16.8	0.28	7.1	1 1/8	28.6	1.17	29.7	1.17	29.7
VUWT-25.4X19.05X9.52	1	25.4	3/4	19.05	3/8	9.52	1.93	49	1.76	44.7	1.65	41.9	1.23	31.2	0.96	24.4	0.66	16.8	0.28	7.1	1 3/8	34.9	1.45	36.8	1.36	34.5

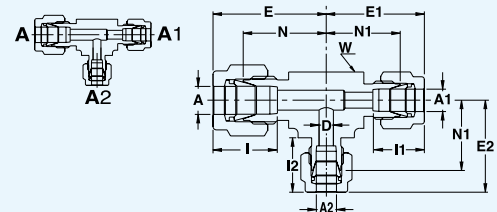
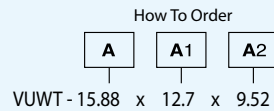

"D" - Dimension is minimum hole diameter - dimensions are for reference only, and are subject to change without notice.

Union Elbows

L

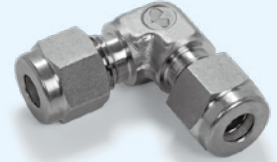
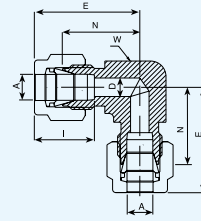

Tube (Metric) To Tube (Metric)

Part Numbers	A Tube O.D.		D		W		N		E		I	
	mm	mm	mm	mm	in	mm	mm	mm	mm	mm	mm	mm
VUWL-3	3		2.4		3/8	9.5		15.7		22.3		12.9
VUWL-4	4		2.4		1/2	12.7		18.8		25.4		13.7
VUWL-6	6		4.8		1/2	12.7		19.6		27		15.3
VUWL-8	8		6.4		9/16	14.3		21.3		28.8		16.2
VUWL-10	10		7.9		11/16	17.5		23.9		31.5		17.2
VUWL-12	12		9.5		13/16	20.6		25.9		36		22.8
VUWL-14	14		11		15/16	23.8		27.9		38		24.4
VUWL-15	15		12		15/16	23.8		27.9		38		24.4
VUWL-16	16		12.7		15/16	23.8		27.9		38		24.4
VUWL-18	18		15.1		1 1/16	27		29.7		39.8		24.4
VUWL-20	20		15.9		1 3/8	34.9		34.5		44.6		26
VUWL-22	22		18.3		1 3/8	34.9		34.5		44.6		26
VUWL-25	25		21.8		1 3/8	34.9		36.8		49.1		31.3

Tube (Inch) To Tube (Inch)

Part Numbers	A Tube O.D.		D		W		N		E		I	
	in	mm	in	mm	in	mm	in	mm	in	mm	in	mm
VUWL-1.6	1/16	1.6	0.05	1.3	3/8	9.5	0.55	14	0.7	17.8	0.34	8.6
VUWL-3.2	1/8	3.2	0.09	2.3	3/8	9.5	0.62	15.7	0.88	22.4	0.5	12.7
VUWL-4.8	3/16	4.8	0.12	3	1/2	12.7	0.74	18.8	1	25.4	0.54	13.7
VUWL-6.35	1/4	6.35	0.19	4.8	1/2	12.7	0.77	19.6	1.06	26.9	0.6	15.2
VUWL-7.93	5/16	7.93	0.25	6.4	9/16	14.3	0.84	21.3	1.13	28.7	0.64	16.3
VUWL-9.52	3/8	9.52	0.28	7.1	5/8	15.9	0.91	23.1	1.2	30.5	0.66	16.8
VUWL-12.7	1/2	12.7	0.41	10.4	13/16	20.6	1.02	25.9	1.42	36.1	0.9	22.9
VUWL-15.88	5/8	15.88	0.5	12.7	15/16	23.8	1.1	27.9	1.5	38.1	0.96	24.4
VUWL-19.05	3/4	19.05	0.62	15.8	1 1/16	27	1.17	29.7	1.57	39.9	0.96	24.4
VUWL-22.22	7/8	22.22	0.72	18.3	1 3/8	34.9	1.36	34.5	1.76	44.7	1.02	25.9
VUWL-25.4	1	25.4	0.88	22.3	1 3/8	34.9	1.45	36.8	1.93	49	1.23	31.2

"D" - Dimension is minimum hole diameter - dimensions are for reference only, and are subject to change without notice.

Female Connectors (NPT)

G

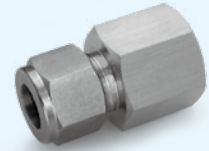
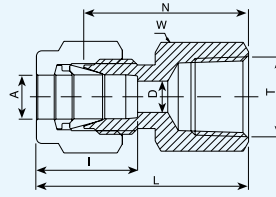

Tube (Metric) To Female NPT Thread

Part Numbers	A Tube O.D.	T	D	W	N	L	I
	mm		mm	mm	mm	mm	mm
VUWG-3AN	3	1/8NPT	2.4	14	22.1	28.7	12.7
VUWG-3BN	3	1/4NPT	2.4	19	26.9	33.5	12.7
VUWG-4AN	4	1/8NPT	2.4	14	23.1	29.7	13.7
VUWG-6AN	6	1/8NPT	4.8	14	23.9	31.3	15.3
VUWG-6BN	6	1/4NPT	4.8	19	28.4	35.8	15.3
VUWG-6CN	6	3/8NPT	4.8	22	30.2	37.6	15.3
VUWG-6DN	6	1/2NPT	4.8	27	35.1	42.5	15.3
VUWG-8AN	8	1/8NPT	6.4	15	24.6	32.1	16.2
VUWG-8BN	8	1/4NPT	6.4	19	29.5	37	16.2
VUWG-8CN	8	3/8NPT	6.4	22	31	38.5	16.2
VUWG-8DN	8	1/2NPT	6.4	27	35.8	43.3	16.2
VUWG-10BN	10	1/4NPT	7.9	19	30.2	37.8	17.2
VUWG-10CN	10	3/8NPT	7.9	22	31.8	39.4	17.2
VUWG-10DN	10	1/2NPT	7.9	27	36.6	44.2	17.2
VUWG-12BN	12	1/4NPT	9.5	22	30.2	40.3	22.8
VUWG-12CN	12	3/8NPT	9.5	22	31.8	41.9	22.8
VUWG-12DN	12	1/2NPT	9.5	27	36.6	46.7	22.8
VUWG-15DN	15	1/2NPT	11.9	27	36.6	46.7	24.4
VUWG-16DN	16	1/2NPT	12.7	27	36.8	46.9	24.4
VUWG-18EN	18	3/4NPT	15.1	35	39.6	49.7	24.4
VUWG-20DN	20	1/2NPT	15.9	30	37.8	47.9	26
VUWG-20EN	20	3/4NPT	15.9	35	39.6	49.7	26
VUWG-22EN	22	3/4NPT	18.3	35	39.6	49.7	26
VUWG-22FN	22	1NPT	18.3	41	47.8	57.9	26
VUWG-25EN	25	3/4NPT	21.8	35	41.1	53.4	31.3
VUWG-25FN	25	1NPT	21.8	41	50	62.3	31.3

Continued on next page

"D" - Dimension is minimum hole diameter - dimensions are for reference only, and are subject to change without notice.

Female Connectors (NPT) (continued)

G

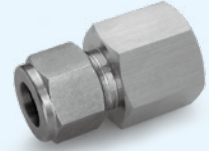
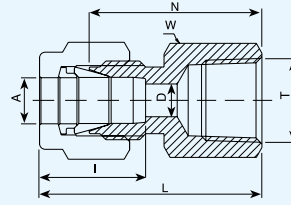

Tube (Inch) To Female NPT Thread

Part Numbers	A Tube O.D.		T	D		W		N		L		I	
	in	mm		in	mm	in	mm	in	mm	in	mm	in	mm
VUWG-3.2AN	1/8	3.2	1/8NPT	0.09	2.3	9/16	14.3	0.87	22.1	1.13	28.7	0.5	12.7
VUWG-3.2BN	1/8	3.2	1/4NPT	0.09	2.3	3/4	19.1	1.06	26.9	1.32	33.5	0.5	12.7
VUWG-4.8AN	3/16	4.8	1/8NPT	0.12	3.04	9/16	14.3	0.91	23.11	1.17	29.7	0.54	13.7
VUWG-6.35AN	1/4	6.35	1/8NPT	0.19	4.8	9/16	14.3	0.94	23.9	1.23	31.2	0.6	15.2
VUWG-6.35BN	1/4	6.35	1/4NPT	0.19	4.8	3/4	19.1	1.12	28.5	1.41	35.8	0.6	15.2
VUWG-6.35CN	1/4	6.35	3/8NPT	0.19	4.8	7/8	22.2	1.19	30.2	1.48	37.6	0.6	15.2
VUWG-6.35DN	1/4	6.35	1/2NPT	0.19	4.8	1 1/16	27	1.38	35	1.67	42.4	0.6	15.2
VUWG-7.93AN	5/16	7.93	1/8NPT	0.25	6.35	9/16	14.3	0.97	24.6	1.26	32	0.64	16.3
VUWG-7.93BN	5/16	7.93	1/4NPT	0.25	6.35	3/4	19.1	1.16	29.5	1.45	36.8	0.64	16.3
VUWG-9.52AN	3/8	9.52	1/8NPT	0.28	7.1	5/8	15.9	1	25.4	1.29	32.8	0.66	16.8
VUWG-9.52BN	3/8	9.52	1/4NPT	0.28	7.1	3/4	19.1	1.19	30.2	1.48	37.6	0.66	16.8
VUWG-9.52CN	3/8	9.52	3/8NPT	0.28	7.1	7/8	22.2	1.25	31.8	1.54	39.1	0.66	16.8
VUWG-9.52DN	3/8	9.52	1/2NPT	0.28	7.1	1 1/16	27	1.44	36.6	1.73	43.9	0.66	16.8
VUWG-12.7BN	1/2	12.7	1/4NPT	0.41	10.4	13/16	20.6	1.19	30.2	1.59	40.4	0.9	22.9
VUWG-12.7CN	1/2	12.7	3/8NPT	0.41	10.4	7/8	22.2	1.25	31.8	1.65	41.9	0.9	22.9
VUWG-12.7DN	1/2	12.7	1/2NPT	0.41	10.4	1 1/16	27	1.44	36.6	1.84	46.7	0.9	22.9
VUWG-12.7EN	1/2	12.7	3/4NPT	0.41	10.4	1 5/16	33.3	1.5	38.1	1.9	48.3	0.9	22.9
VUWG-15.88CN	5/8	15.88	3/8NPT	0.5	12.7	15/16	23.8	1.25	31.8	1.65	41.9	0.96	24.4
VUWG-15.88DN	5/8	15.88	1/2NPT	0.5	12.7	1 1/16	27	1.44	36.6	1.84	46.7	0.96	24.4
VUWG-19.05DN	3/4	19.05	1/2NPT	0.62	15.8	1 1/16	27	1.44	36.6	1.84	46.7	0.96	24.4
VUWG-19.05EN	3/4	19.05	3/4NPT	0.62	15.8	1 5/16	33.3	1.5	38.1	1.9	48.3	0.96	24.4
VUWG-22.22EN	7/8	22.22	3/4NPT	0.72	18.3	1 5/16	33.3	1.56	39.6	1.96	49.8	1.02	25.9
VUWG-25.4EN	1	25.4	3/4NPT	0.88	22.3	1 3/8	34.9	1.62	41.1	2.1	53.3	1.23	31.2
VUWG-25.4FN	1	25.4	1NPT	0.88	22.3	1 5/8	41.3	1.97	50	2.45	62.2	1.23	31.2

"D" - Dimension is minimum hole diameter - dimensions are for reference only, and are subject to change without notice.

Female Connectors (Rc)

G

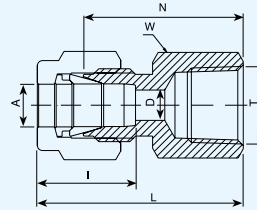

Tube (Metric) To Female ISO Tapered Thread

Part Numbers	A Tube O.D.	T	D	W	N	L	I
	mm		mm	mm	mm	mm	mm
VUWG-3A	3	Rc 1/8	2.4	14	22.1	28.7	12.9
VUWG-6A	6	Rc 1/8	4.8	14	23.9	31.3	15.3
VUWG-6B	6	Rc 1/4	4.8	19	28.4	35.8	15.3
VUWG-6C	6	Rc 3/8	4.8	22	30.2	37.6	15.3
VUWG-6D	6	Rc 1/2	4.8	27	35.1	42.5	15.3
VUWG-8A	8	Rc 1/8	6.4	14	24.6	32.1	16.2
VUWG-8B	8	Rc 1/4	6.4	19	29.5	37	16.2
VUWG-8C	8	Rc 3/8	6.4	22	31	38.5	16.2
VUWG-8D	8	Rc 1/2	6.4	27	35.8	43.3	16.2
VUWG-10A	10	Rc 1/8	7.9	18	25.4	33	17.2
VUWG-10B	10	Rc 1/4	7.9	19	30.2	37.8	17.2
VUWG-10C	10	Rc 3/8	7.9	22	31.8	39.4	17.2
VUWG-10D	10	Rc 1/2	7.9	27	36.6	44.2	17.2
VUWG-12A	12	Rc 1/8	8.3	22	25.4	35.5	22.8
VUWG-12B	12	Rc 1/4	9.5	22	30.2	40.3	22.8
VUWG-12C	12	Rc 3/8	9.5	22	31.8	41.9	22.8
VUWG-12D	12	Rc 1/2	9.5	27	36.6	46.7	22.8
VUWG-12E	12	Rc 3/4	9.5	35	38.9	49	22.8
VUWG-15C	15	Rc 3/8	11.9	24	31.8	41.9	24.4
VUWG-15D	15	Rc 1/2	11.9	27	36.6	46.7	24.4
VUWG-20D	20	Rc 1/2	15.9	30	37.8	47.9	26
VUWG-20E	20	Rc 3/4	15.9	35	39.6	49.7	26
VUWG-22E	22	Rc 3/4	18.3	35	39.6	49.7	26
VUWG-22F	22	Rc 1	18.3	41	47.8	57.9	26
VUWG-25E	25	Rc 3/4	21.8	35	41.1	53.4	31.3
VUWG-25F	25	Rc 1	21.8	41	50	62.3	31.3

Designation:

R marking on hex of body

"D" - Dimension is minimum hole diameter - dimensions are for reference only, and are subject to change without notice.

Female Connectors (Rc) (continued)

G

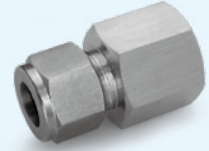
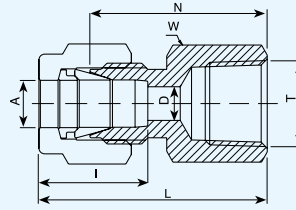

Tube (Inch) To Female ISO Tapered Thread

Part Numbers	A Tube O.D.		T	D		W		N		L		I	
	in	mm		in	mm	in	mm	in	mm	in	mm	in	mm
VUWG-3.2A	1/8	3.2	Rc 1/8	0.09	2.3	9/16	14.3	0.87	22.1	1.13	28.7	0.5	12.7
VUWG-3.2B	1/8	3.2	Rc 1/4	0.09	2.3	3/4	19.1	1.06	26.9	1.32	33.5	0.5	12.7
VUWG-4.8A	3/16	4.8	Rc 1/8	0.12	3.04	9/16	14.3	0.91	23.11	1.17	29.7	0.54	13.7
VUWG-6.35A	1/4	6.35	Rc 1/8	0.19	4.8	9/16	14.3	0.94	23.9	1.23	31.2	0.6	15.2
VUWG-6.35B	1/4	6.35	Rc 1/4	0.19	4.8	3/4	19.1	1.12	28.5	1.41	35.8	0.6	15.2
VUWG-6.35C	1/4	6.35	Rc 3/8	0.19	4.8	7/8	22.2	1.19	30.2	1.48	37.6	0.6	15.2
VUWG-6.35D	1/4	6.35	Rc 1/2	0.19	4.8	1 1/16	27	1.38	35	1.67	42.4	0.6	15.2
VUWG-7.93A	5/16	7.93	Rc 1/8	0.25	6.35	9/16	14.3	0.97	24.6	1.26	32	0.64	16.3
VUWG-7.93B	5/16	7.93	Rc 1/4	0.25	6.35	3/4	19.1	1.16	29.5	1.45	36.8	0.64	16.3
VUWG-9.52A	3/8	9.52	Rc 1/8	0.28	7.1	5/8	15.9	1	25.4	1.29	32.8	0.66	16.8
VUWG-9.52B	3/8	9.52	Rc 1/4	0.28	7.1	3/4	19.1	1.19	30.2	1.48	37.6	0.66	16.8
VUWG-9.52C	3/8	9.52	Rc 3/8	0.28	7.1	7/8	22.2	1.25	31.8	1.54	39.1	0.66	16.8
VUWG-9.52D	3/8	9.52	Rc 1/2	0.28	7.1	1 1/16	27	1.44	36.6	1.73	43.9	0.66	16.8
VUWG-12.7B	1/2	12.7	Rc 1/4	0.41	10.4	13/16	20.6	1.19	30.2	1.59	40.4	0.9	22.9
VUWG-12.7C	1/2	12.7	Rc 3/8	0.41	10.4	7/8	22.2	1.25	31.8	1.65	41.9	0.9	22.9
VUWG-12.7D	1/2	12.7	Rc 1/2	0.41	10.4	1 1/16	27	1.44	36.6	1.84	46.7	0.9	22.9
VUWG-12.7E	1/2	12.7	Rc 3/4	0.41	10.4	1 5/16	33.3	1.5	38.1	1.9	48.3	0.9	22.9
VUWG-15.88C	5/8	15.88	Rc 3/8	0.5	12.7	15/16	23.8	1.25	31.8	1.65	41.9	0.96	24.4
VUWG-15.88D	5/8	15.88	Rc 1/2	0.5	12.7	1 1/16	27	1.44	36.6	1.84	46.7	0.96	24.4
VUWG-19.05D	3/4	19.05	Rc 1/2	0.62	15.8	1 1/16	27	1.44	36.6	1.84	46.7	0.96	24.4
VUWG-19.05E	3/4	19.05	Rc 3/4	0.62	15.8	1 5/16	33.3	1.5	38.1	1.9	48.3	0.96	24.4
VUWG-22.22E	7/8	22.22	Rc 3/4	0.72	18.3	1 5/16	33.3	1.56	39.6	1.96	49.8	1.02	25.9
VUWG-25.4E	1	25.4	Rc 3/4	0.88	22.3	1 3/8	34.9	1.62	41.1	2.1	53.3	1.23	31.2
VUWG-25.4F	1	25.4	Rc 1	0.88	22.3	1 5/8	41.3	1.97	50	2.45	62.2	1.23	31.2

"D" - Dimension is minimum hole diameter - dimensions are for reference only, and are subject to change without notice.

Female Connectors (G)

G

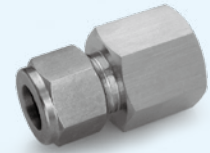
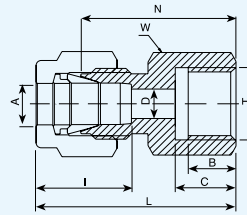

Tube (Metric) To Female ISO Parallel Thread

Part Numbers	A Tube O.D.		T	D	W		N	L	I	B	C
	mm				mm	mm					
VUWG-6AF-PG	6		G 1/8	4.8	14	25	32.4	15.3	7	10	
VUWG-6BF-PG	6		G 1/4	4.8	19	30.2	37.6	15.3	10	13	
VUWG-6CF-PG	6		G 3/8	4.8	24	30.2	37.6	15.3	12	15	
VUWG-6DF-PG	6		G 1/2	4.8	27	36.1	43.5	15.3	15	18	
VUWG-8BF-PG	8		G 1/4	5.5	19	31	38.5	16.2	10	13	
VUWG-8CF-PG	8		G 3/8	5.5	24	29.6	37.1	16.2	12	15	
VUWG-8DF-PG	8		G 1/2	5.5	27	33.5	41	16.2	15	18	
VUWG-10BF-PG	10		G 1/4	5.5	19	31.8	39.4	17.2	10	13	
VUWG-10CF-PG	10		G 3/8	5.5	24	31.2	38.8	17.2	12	15	
VUWG-10DF-PG	10		G 1/2	5.5	27	34.5	42.1	17.2	15	18	
VUWG-12BF-PG	12		G 1/4	5.5	22	31.8	41.9	22.8	10	13	
VUWG-12CF-PG	12		G 3/8	5.5	24	34.3	44.4	22.8	12	15	
VUWG-12DF-PG	12		G 1/2	5.5	27	38.1	48.2	22.8	15	18	

Tube (Inch) To Female ISO Parallel Thread

Part Numbers	A Tube O.D.		T	D	W		N	L	I	B	C
	in	mm			in	mm					
VUWG-1.6CF-PG	1/16	1.58	G3/8	1.25	15/16	23.8	31	34.8	8.6	12	15
VUWG-3.2AF-PG	1/8	3.17	G1/8	2.3	9/16	14.3	24.5	31.1	12.7	7	10
VUWG-3.2CF-PG	1/8	3.17	G3/8	2.3	15/16	23.8	32.7	39.3	12.7	12	15
VUWG-6.35AF-PG	1/4	6.35	G1/8	5.5	9/16	14.3	25	32.4	15.2	7	10
VUWG-6.35BF-PG	1/4	6.35	G1/4	5.5	3/4	19.1	30.2	37.6	15.2	10	13
VUWG-6.35CF-PG	1/4	6.35	G3/8	5.5	15/16	23.8	30.2	37.6	15.2	12	15
VUWG-6.35DF-PG	1/4	6.35	G1/2	5.5	1-1/16	27	36.1	43.4	15.2	15	18
VUWG-9.52BF-PG	3/8	9.52	G1/4	5.5	3/4	19.1	31.8	39.1	16.8	10	13
VUWG-9.52CF-PG	3/8	9.52	G3/8	5.5	15/16	23.8	32.1	38.6	16.8	12	15
VUWG-9.52DF-PG	3/8	9.52	G1/2	5.5	1-1/16	27	34.5	41.9	16.8	15	18
VUWG-12.7BF-PG	1/2	12.7	G1/4	5.5	13/16	20.6	31.8	42	22.9	10	13
VUWG-12.7CF-PG	1/2	12.7	G3/8	5.5	15/16	23.8	34.3	44.5	22.9	12	15
VUWG-12.7DF-PG	1/2	12.7	G1/2	5.5	1-1/16	27	38.1	48.3	22.9	15	18

Designation:

PG marking on hex of body

"D" - Dimension is minimum hole diameter - dimensions are for reference only, and are subject to change without notice.

Reducers

R

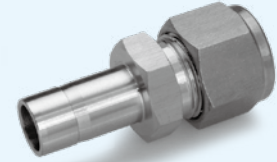
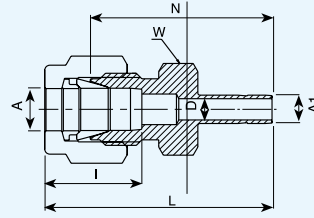

Tube (Metric) To Stub (Metric)

Part Numbers	A	A1	D	W	N	L	I
	Tube O.D. mm	Tube O.D. mm	mm	mm	mm	mm	mm
VUWR-2X3	2	3	1.7	12	26.9	33.5	12.9
VUWR-3X4	3	4	2.4	12	28.4	35	12.9
VUWR-3X6	3	6	2.4	12	29.5	36.1	12.9
VUWR-3X10	3	10	2.4	14	31.8	38.4	12.9
VUWR-4X6	4	6	2.4	12	30.5	37.1	13.7
VUWR-6X3	6	3	1.8	14	29.5	36.9	15.3
VUWR-6X8	6	8	4.8	14	32.5	39.9	15.3
VUWR-6X10	6	10	4.8	14	33.3	40.7	15.3
VUWR-6X12	6	12	4.8	14	38.9	46.3	15.3
VUWR-6X18	6	18	4.8	22	42.2	49.6	15.3
VUWR-8X6	8	6	4	15	32.8	40.3	16.2
VUWR-8X10	8	10	6.4	15	34.5	42	16.2
VUWR-8X12	8	12	6.4	15	40.1	47.6	16.2
VUWR-10X6	10	6	4	18	34.8	42.4	17.2
VUWR-10X8	10	8	5.6	18	35.8	43.4	17.2
VUWR-10X12	10	12	7.9	18	42.2	49.8	17.2
VUWR-10X15	10	15	7.9	18	43.7	51.3	17.2
VUWR-10X18	10	18	7.9	22	43.7	51.3	17.2
VUWR-12X6	12	6	4	22	34.8	44.9	22.8
VUWR-12X10	12	10	7.1	22	36.6	46.7	22.8
VUWR-12X16	12	16	9.5	22	43.7	53.8	22.8
VUWR-12X18	12	18	9.5	22	43.7	53.8	22.8
VUWR-12X20	12	20	9.5	22	46	56.1	22.8
VUWR-12X22	12	22	9.5	24	46	56.1	22.8
VUWR-12X25	12	25	9.5	27	52.3	62.4	22.8
VUWR-16X12	16	12	8.8	24	42.9	53	24.4
VUWR-18X12	18	12	8.8	27	44.5	54.6	24.4
VUWR-18X16	18	16	12.7	27	46	56.1	24.4
VUWR-18X20	18	20	15.1	27	47.5	57.6	24.4
VUWR-18X22	18	22	15.1	27	47.5	57.6	24.4
VUWR-18X25	18	25	15.1	27	52.3	62.4	24.4
VUWR-20X16	20	16	12.7	30	47.8	57.9	26
VUWR-20X18	20	18	13.9	30	47.8	57.9	26
VUWR-20X22	20	22	15.8	30	49.3	59.4	26
VUWR-20X25	20	25	15.9	30	54.1	64.2	26
VUWR-22X18	22	18	13.9	30	47.8	57.9	26
VUWR-22X20	22	20	15.1	30	49.3	59.4	26
VUWR-22X25	22	25	18.3	30	54.1	64.2	26
VUWR-25X18	25	18	13.9	35	50.8	63.1	31.3
VUWR-25X20	25	20	15.1	35	52.3	64.6	31.3

Continued on next page

"D" - Dimension is minimum hole diameter - dimensions are for reference only, and are subject to change without notice.

Reducers (continued)

R

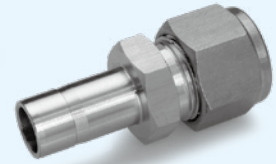
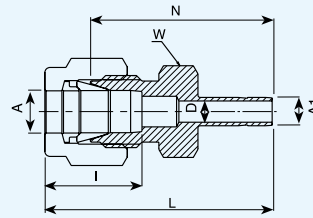

Tube (Metric) To Stub (Inch)

Part Numbers	A	A1	D	W	N	L	I
	Tube O.D.	Tube O.D.	mm	mm	mm	mm	mm
VUWR-2X3.2	2	3.2	1.7	12	26.9	33.5	12.9
VUWR-3X3.2	3	3.2	2	12	26.9	33.5	12.9
VUWR-3X6.35	3	6.35	2.4	12	29.5	36.1	12.9
VUWR-4X6.35	4	6.35	2.4	12	30.5	37.1	13.7
VUWR-6X3.2	6	3.2	2.2	14	29.5	36.9	15.3
VUWR-6X7.93	6	7.93	4.8	14	32.5	39.9	15.3
VUWR-6X9.52	6	9.52	4.8	14	33.3	40.7	15.3
VUWR-6X12.7	6	12.7	4.8	14	38.9	46.3	15.3
VUWR-8X9.52	8	9.52	6.4	15	34.5	42	16.2
VUWR-8X12.7	8	12.7	6.4	15	40.1	47.6	16.2
VUWR-10X9.52	10	9.52	6.9	18	36.6	44.2	17.2
VUWR-10X12.7	10	12.7	7.9	18	42.2	49.8	17.2
VUWR-12X12.7	12	12.7	9.4	22	42.2	52.3	22.8
VUWR-12X19.05	12	19.05	9.5	22	43.7	53.8	22.8
VUWR-18X19.05	18	19.05	15.1	27	46	56.1	24.4
VUWR-18X25.4	18	25.4	15.1	27	52.3	62.4	24.4
VUWR-25X25.4	25	25.4	20.2	35	57.2	69.4	31.3

Continued on next page

"D" - Dimension is minimum hole diameter - dimensions are for reference only, and are subject to change without notice.

Reducers (continued)

R

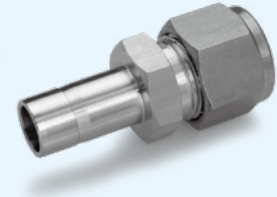
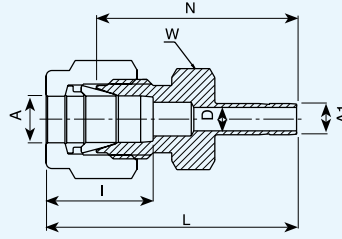

Tube (Inch) To Stub (Inch)

Part Numbers	A Tube O.D.		A1 Tube O.D.		D		W		N		L		I	
	in	mm	in	mm	in	mm	in	mm	in	mm	in	mm	in	mm
VUWR-1.6X3.2	1/16	1.6	1/8	3.2	0.05	1.3	5/16	7.9	1	25.4	1.15	29.2	0.34	8.6
VUWR-1.6X6.35	1/16	1.6	1/4	6.35	0.05	1.3	5/16	7.9	1.09	27.7	1.24	31.5	0.34	8.6
VUWR-3.2X1.6	1/8	3.2	1/16	1.6	0.03	0.8	7/16	11.1	0.88	22.4	1.14	29	0.5	12.7
VUWR-3.2X4.8	1/8	3.2	3/16	4.8	0.09	2.3	7/16	11.1	1.09	27.7	1.35	34.3	0.5	12.7
VUWR-3.2X6.35	1/8	3.2	1/4	6.35	0.09	2.3	7/16	11.1	1.16	29.5	1.42	36.1	0.5	12.7
VUWR-3.2X9.52	1/8	3.2	3/8	9.52	0.09	2.3	7/16	11.1	1.22	31	1.48	37.6	0.5	12.7
VUWR-3.2X12.7	1/8	3.2	1/2	12.7	0.09	2.3	9/16	14.3	1.48	37.6	1.74	44.2	0.5	12.7
VUWR-4.8X3.2	3/16	4.8	1/8	3.2	0.09	2.3	7/16	11.1	1.11	28.2	1.37	34.8	0.54	13.7
VUWR-4.8X6.35	3/16	4.8	1/4	6.35	0.12	3.1	7/16	11.1	1.2	30.5	1.46	37.1	0.6	13.7
VUWR-6.35X3.2	1/4	6.35	1/8	3.2	0.09	2.3	1/2	12.7	1.16	29.5	1.45	36.8	0.6	15.2
VUWR-6.35X4.8	1/4	6.35	3/16	4.8	0.12	3	1/2	12.7	1.19	30.2	1.48	37.6	0.6	15.2
VUWR-6.35X6.35	1/4	6.35	1/4	6.35	0.17	4.2	1/2	12.7	1.25	31.8	1.54	39.1	0.6	15.2
VUWR-6.35X7.93	1/4	6.35	5/16	7.93	0.19	4.8	1/2	12.7	1.28	32.5	1.57	39.9	0.6	15.2
VUWR-6.35X9.52	1/4	6.35	3/8	9.52	0.19	4.8	1/2	12.7	1.31	33.3	1.6	40.6	0.6	15.2
VUWR-6.35X12.7	1/4	6.35	1/2	12.7	0.19	4.8	9/16	14.3	1.53	38.9	1.82	46.2	0.6	15.2
VUWR-6.35X15.88	1/4	6.35	5/8	15.88	0.19	4.8	11/16	17.5	1.6	40.6	1.89	48	0.6	15.2
VUWR-6.35X19.05	1/4	6.35	3/4	19.05	0.19	4.8	13/16	20.6	1.59	40.4	1.88	47.8	0.6	15.2
VUWR-7.93X9.52	5/16	7.93	3/8	9.52	0.25	6.4	9/16	14.3	1.36	34.5	1.65	41.9	0.64	16.3
VUWR-7.93X12.7	5/16	7.93	1/2	12.7	0.25	6.4	9/16	14.3	1.58	40.1	1.87	47.5	0.64	16.3
VUWR-9.52X6.35	3/8	9.52	1/4	6.35	0.17	4.2	5/8	15.9	1.34	34	1.63	41.4	0.66	16.8
VUWR-9.52X9.52	3/8	9.52	3/8	9.52	0.27	6.9	5/8	15.9	1.41	35.8	1.7	43.2	0.66	16.8
VUWR-9.52X12.7	3/8	9.52	1/2	12.7	0.28	7.1	5/8	15.9	1.62	41.2	1.91	48.5	0.66	16.8
VUWR-9.52X15.88	3/8	9.52	5/8	15.88	0.28	7.1	11/16	17.5	1.69	42.9	1.98	50.3	0.66	16.8
VUWR-9.52X19.05	3/8	9.52	3/4	19.05	0.28	7.1	13/16	20.6	1.69	42.9	1.98	50.3	0.66	16.8
VUWR-12.7X6.35	1/2	12.7	1/4	6.35	0.17	4.2	13/16	20.6	1.37	34.8	1.77	45	0.9	22.9
VUWR-12.7X9.52	1/2	12.7	3/8	9.52	0.27	6.9	13/16	20.6	1.44	36.6	1.84	46.7	0.9	22.9
VUWR-12.7X12.7	1/2	12.7	1/2	12.7	0.37	9.4	13/16	20.6	1.66	42.2	2.06	52.3	0.9	22.9
VUWR-12.7X15.88	1/2	12.7	5/8	15.88	0.41	10.4	13/16	20.6	1.72	43.7	2.12	53.8	0.9	22.9
VUWR-12.7X19.05	1/2	12.7	3/4	19.05	0.41	10.4	13/16	20.6	1.72	43.7	2.12	53.9	0.9	22.9
VUWR-12.7X25.4	1/2	12.7	1	25.4	0.41	10.4	1 1/16	27	1.97	50	2.37	60.2	0.9	22.9
VUWR-15.88X19.05	5/8	15.88	3/4	19.05	0.5	12.7	15/16	23.8	1.75	44.5	2.15	54.6	0.96	24.4
VUWR-15.88X22.22	5/8	15.88	7/8	22.22	0.5	12.7	15/16	23.8	1.81	46	2.21	56.1	0.96	24.4
VUWR-15.88X25.4	5/8	15.88	1	25.4	0.5	12.7	1 1/16	27	2	50.8	2.4	61	0.96	24.4
VUWR-19.05X12.7	3/4	19.05	1/2	12.7	0.37	9.4	1 1/16	27	1.75	44.5	2.15	54.6	0.96	24.4
VUWR-19.05X25.4	3/4	19.05	1	25.4	0.62	15.8	1 1/16	27	2.06	52.3	2.46	62.5	0.96	24.4

Assembly Instructions

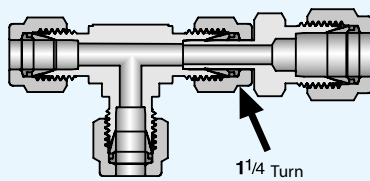

"D" - Dimension is minimum hole diameter - dimensions are for reference only, and are subject to change without notice.

Port Connectors

PC

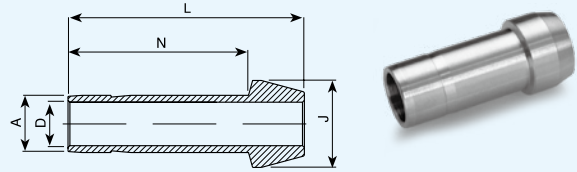

Connects Two V_®-Lok Ports (Metric)

Part Numbers	A Tube O.D.		D		N		L		J	
	mm	mm	mm	mm	mm	mm	mm	mm	mm	mm
VUW-PC-3	3		2.1		15.7		22.2		6	
VUW-PC-6	6		4		19.1		25		9	
VUW-PC-8	8		5.6		20		25.9		11	
VUW-PC-10	10		7.1		21.2		27.1		13.1	
VUW-PC-12	12		8.8		26.4		36.2		15	
VUW-PC-16	16		12.7		27.6		37.4		19	
VUW-PC-18	18		13.9		27.6		37.4		21.1	

Connects Two V_®-Lok Ports (Inch)

Part Numbers	A Tube O.D.		D		N		L		J	
	in	mm	in	mm	in	mm	in	mm	in	mm
VUW-PC-1.6	1/16	1.6	0.03	0.8	0.42	10.7	0.54	13.7	0.13	3.3
VUW-PC-3.2	1/8	3.2	0.09	2.2	0.62	15.7	0.88	22.4	0.24	6.1
VUW-PC-6.35	1/4	6.35	0.17	4.2	0.75	19	0.98	24.9	0.37	9.4
VUW-PC-7.93	5/16	7.93	0.24	6	0.79	20	1.02	25.9	0.43	10.9
VUW-PC-9.52	3/8	9.52	0.27	6.9	0.8	20.3	1.03	26.2	0.49	12.6
VUW-PC-12.7	1/2	12.7	0.37	9.4	1.02	25.9	1.41	35.8	0.62	15.7
VUW-PC-19.05	3/4	19.05	0.59	15	1.09	27.7	1.47	37.3	0.87	22.1
VUW-PC-25.4	1	25.4	0.8	20.3	1.37	34.7	1.9	48.1	1.12	28.5

Assembly Instructions

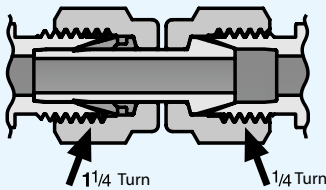

"D" - Dimension is minimum hole diameter - dimensions are for reference only, and are subject to change without notice.

Reducing Port Connectors

PC

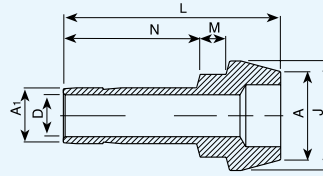

Connects Two V_o-Lok Ports (Metric)

Part Numbers	A Tube O.D.		A1 Tube O.D.		D		N		L		J		M	
	mm	mm	mm	mm	mm	mm	mm	mm	mm	mm	mm	mm	mm	mm
VUW-PC-6X3	6	3			2.1		13.5		22.9		9		3.2	
VUW-PC-8X6	8	6			4		15.7		24.7		11		3.1	
VUW-PC-10X6	10	6			4		15.7		25.8		13.1		3.4	
VUW-PC-10X8	10	8			5.6		16.8		26.1		13.1		3.1	
VUW-PC-12X6	12	6			4		15.7		29.1		15		3.6	
VUW-PC-12X8	12	8			5.6		16.8		30.1		15		3.4	
VUW-PC-12X10	12	10			7.1		17.5		30.6		15		3.1	
VUW-PC-16X12	16	12			8.8		23.1		37.5		19		3.4	

Connects Two V_o-Lok Ports (Inch)

Part Numbers	A Tube O.D.		A1 Tube O.D.		D		N		L		J		M	
	in	mm	in	mm	in	mm	in	mm	in	mm	in	mm	in	mm
VUW-PC-3.2X1.6	1/8	3.2	1/16	1.6	0.03	0.8	0.34	8.6	0.68	17.3	0.24	6.1	0.08	2
VUW-PC-6.35X1.6	1/4	6.35	1/16	1.6	0.03	0.8	0.34	8.6	0.71	18	0.37	9.4	0.14	3.6
VUW-PC-6.35X3.2	1/4	6.35	1/8	3.2	0.09	2.2	0.53	13.5	0.89	22.6	0.37	9.4	0.13	3.3
VUW-PC-9.52X3.2	3/8	9.52	1/8	3.2	0.09	2.2	0.53	13.5	0.91	23.2	0.49	12.6	0.15	3.9
VUW-PC-9.52X6.35	3/8	9.52	1/4	6.35	0.17	4.2	0.62	15.7	0.98	24.9	0.49	12.6	0.13	3.3
VUW-PC-12.7X6.35	1/2	12.7	1/4	6.35	0.17	4.2	0.62	15.7	1.15	29.2	0.62	15.7	0.15	3.8
VUW-PC-12.7X9.52	1/2	12.7	3/8	9.52	0.27	6.9	0.69	17.5	1.2	30.5	0.62	15.7	0.13	3.3
VUW-PC-19.05X12.7	3/4	19.05	1/2	12.7	0.37	9.4	0.96	24.4	1.49	37.9	0.87	22.1	0.15	3.8

Assembly Instructions

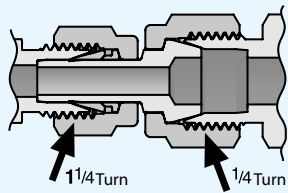

"D" - Dimension is minimum hole diameter - dimensions are for reference only, and are subject to change without notice.

Male Connectors (NPT)

H

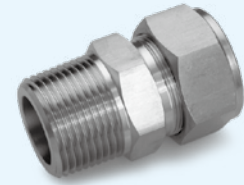
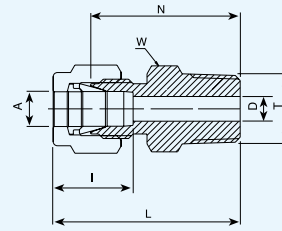

Tube (Metric) Male NPT Thread

Part Numbers	A	T	D	W	N	L	I
	Tube O.D. mm		mm	mm	mm	mm	mm
VUWH-3AN	3	1/8NPT	2.4	12	23.9	30.5	12.9
VUWH-3BN	3	1/4NPT	2.4	14	29	35.6	12.9
VUWH-4AN	4	1/8NPT	2.4	12	24.6	31.2	13.7
VUWH-4BN	4	1/4NPT	2.4	14	29.7	36.3	13.7
VUWH-6AN	6	1/8NPT	4.8	14	25.4	32.8	15.3
VUWH-6BN	6	1/4NPT	4.8	14	30.5	37.9	15.3
VUWH-6CN	6	3/8NPT	4.8	18	31	38.4	15.3
VUWH-6DN	6	1/2NPT	4.8	22	37.3	44.7	15.3
VUWH-8AN	8	1/8NPT	4.8	15	26.7	34.2	16.2
VUWH-8BN	8	1/4NPT	6.4	15	31.2	38.7	16.2
VUWH-8CN	8	3/8NPT	6.4	18	31.8	39.3	16.2
VUWH-8DN	8	1/2NPT	6.4	22	38.1	45.6	16.2
VUWH-10AN	10	1/8NPT	4.8	18	28.7	36.3	17.2
VUWH-10BN	10	1/4NPT	7.9	18	33.3	40.9	17.2
VUWH-10CN	10	3/8NPT	7.9	18	33.3	40.9	17.2
VUWH-10DN	10	1/2NPT	7.9	22	38.9	46.5	17.2
VUWH-10EN	10	3/4NPT	7.9	27	40.4	48	17.2
VUWH-12AN	12	1/8NPT	4.8	22	28.7	38.8	22.8
VUWH-12BN	12	1/4NPT	7.1	22	33.3	43.4	22.8
VUWH-12CN	12	3/8NPT	9.5	22	33.3	43.4	22.8
VUWH-12DN	12	1/2NPT	9.5	22	38.9	49	22.8
VUWH-12EN	12	3/4NPT	9.5	27	40.4	50.5	22.8
VUWH-14BN	14	1/4NPT	7.1	24	34	44.1	24.4
VUWH-14CN	14	3/8NPT	9.5	24	34	44.1	24.4
VUWH-14DN	14	1/2NPT	11	24	38.9	49	24.4
VUWH-15DN	15	1/2NPT	12	24	38.9	49	24.4
VUWH-16CN	16	3/8NPT	9.5	24	34	44.1	24.4
VUWH-16DN	16	1/2NPT	11.9	24	38.9	49	24.4
VUWH-16EN	16	3/4NPT	12.7	27	40.4	50.5	24.4
VUWH-18DN	18	1/2NPT	11.9	27	40.4	50.5	24.4
VUWH-18EN	18	3/4NPT	15.1	27	40.4	50.5	24.4
VUWH-20DN	20	1/2NPT	11.9	30	42.2	52.3	26
VUWH-20EN	20	3/4NPT	15.9	30	42.2	52.3	26
VUWH-22EN	22	3/4NPT	15.9	30	42.2	52.3	26
VUWH-22FN	22	1NPT	18.3	35	47	57.1	26
VUWH-25DN	25	1/2NPT	11.9	35	45.2	57.5	31.3
VUWH-25EN	25	3/4NPT	15.9	35	45.2	57.5	31.3
VUWH-25FN	25	1NPT	21.8	35	50	62.3	31.3

For inches, see next page

Thermoelement

For ordering: use catalog number of the selected fitting and add the suffix T/C.
Example: VUWH - 6.35 BN - T/C

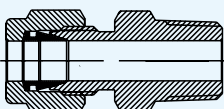

"D" - Dimension is minimum hole diameter - dimensions are for reference only, and are subject to change without notice.

Male Connectors (NPT) (continued)

H

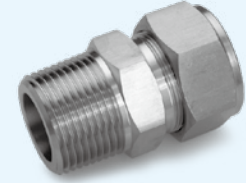
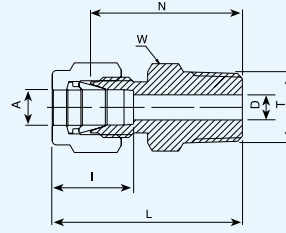

Tube (Inch) Male NPT Thread

Part Numbers	A Tube O.D.		T	D		W		N		L		I	
	in	mm		in	mm	in	mm	in	mm	in	mm	in	mm
VUWH-1.6AN	1/16	1.6	1/8NPT	0.05	1.3	7/16	11.1	0.88	22.35	1.03	26.2	0.34	8.6
VUWH-3.2AN	1/8	3.2	1/8NPT	0.09	2.3	7/16	11.1	0.94	23.9	1.2	30.5	0.5	12.7
VUWH-3.2BN	1/8	3.2	1/4NPT	0.09	2.3	9/16	14.3	1.14	29	1.4	35.6	0.5	12.7
VUWH-4.8AN	3/16	4.8	1/8NPT	0.12	3.1	7/16	11.1	0.97	24.6	1.23	31.2	0.54	13.7
VUWH-4.8BN	3/16	4.8	1/4NPT	0.12	3.1	9/16	14.3	1.17	29.7	1.43	36.3	0.54	13.7
VUWH-6.35AN	1/4	6.35	1/8NPT	0.19	4.8	1/2	12.7	1	25.4	1.29	32.8	0.6	15.2
VUWH-6.35BN	1/4	6.35	1/4NPT	0.19	4.8	9/16	14.3	1.2	30.5	1.49	37.9	0.6	15.2
VUWH-6.35CN	1/4	6.35	3/8NPT	0.19	4.8	11/16	17.5	1.22	31	1.51	38.4	0.6	15.2
VUWH-6.35DN	1/4	6.35	1/2NPT	0.19	4.8	7/8	22.2	1.47	37.3	1.76	44.7	0.6	15.2
VUWH-7.93AN	5/16	7.93	1/8NPT	0.19	4.8	9/16	14.3	1.05	26.7	1.34	34	0.64	16.2
VUWH-7.93BN	5/16	7.93	1/4NPT	0.25	6.4	9/16	14.3	1.23	31.2	1.52	38.6	0.64	16.2
VUWH-9.52AN	3/8	9.52	1/8NPT	0.19	4.8	5/8	15.9	1.1	27.9	1.39	35.3	0.66	16.8
VUWH-9.52BN	3/8	9.52	1/4NPT	0.28	7.1	5/8	15.9	1.28	32.5	1.57	39.9	0.66	16.8
VUWH-9.52CN	3/8	9.52	3/8NPT	0.28	7.1	11/16	17.5	1.28	32.5	1.57	39.9	0.66	16.8
VUWH-9.52DN	3/8	9.52	1/2NPT	0.28	7.1	7/8	22.2	1.52	38.9	1.82	46.2	0.66	16.8
VUWH-9.52EN	3/8	9.52	3/4NPT	0.28	7.1	1 1/16	27	1.59	40.4	1.88	47.8	0.66	16.8
VUWH-12.7AN	1/2	12.7	1/8NPT	0.19	4.8	13/16	20.6	1.13	28.7	1.53	38.9	0.9	22.9
VUWH-12.7BN	1/2	12.7	1/4NPT	0.28	7.1	13/16	20.6	1.31	33.3	1.71	43.4	0.9	22.9
VUWH-12.7CN	1/2	12.7	3/8NPT	0.38	9.6	13/16	20.6	1.31	33.3	1.71	43.4	0.9	22.9
VUWH-12.7DN	1/2	12.7	1/2NPT	0.41	10.4	7/8	22.2	1.53	38.9	1.93	49	0.9	22.9
VUWH-12.7EN	1/2	12.7	3/4NPT	0.41	10.4	1 1/16	27	1.59	40.4	1.99	50.5	0.9	22.9
VUWH-12.7FN	1/2	12.7	1NPT	0.41	10.4	1 3/8	34.9	1.85	47	2.25	57.2	0.9	22.9
VUWH-15.88CN	5/8	15.88	3/8NPT	0.38	9.6	15/16	23.8	1.34	34	1.74	44.2	0.96	24.4
VUWH-15.88DN	5/8	15.88	1/2NPT	0.47	11.9	15/16	23.8	1.53	38.9	1.93	49	0.96	24.4
VUWH-15.88EN	5/8	15.88	3/4NPT	0.5	12.7	1 1/16	27	1.59	40.4	1.99	50.5	0.96	24.4
VUWH-19.05DN	3/4	19.05	1/2NPT	0.5	11.9	1 1/16	27	1.59	40.4	1.99	50.5	0.96	24.4
VUWH-19.05EN	3/4	19.05	3/4NPT	0.62	15.8	1 1/16	27	1.59	40.4	1.99	50.5	0.96	24.4
VUWH-19.05FN	3/4	19.05	1NPT	0.62	15.8	1 3/8	34.9	1.85	47	2.25	57.2	0.96	24.4
VUWH-22.22EN	7/8	22.22	3/4NPT	0.72	18.3	1 3/16	30.2	1.59	40.4	1.99	50.5	1.02	25.9
VUWH-25.4EN	1	25.4	3/4NPT	0.72	15.8	1 3/8	34.9	1.78	45.2	2.26	57.4	1.23	31.2
VUWH-25.4FN	1	25.4	1NPT	0.88	22.3	1 3/8	34.9	1.97	50	2.45	62.2	1.23	31.2

Reference Specifications:

American Standard Pipe Thread (NPT).
NPT (National Pipe Tapered) is made to specifications outlined in ANSI B1.20.1.

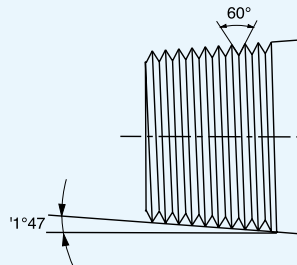

"D" - Dimension is minimum hole diameter - dimensions are for reference only, and are subject to change without notice.

Male Connectors (R)

H

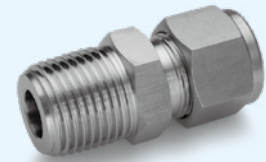
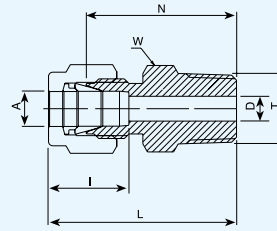

Tube (Metric) ISO Tapered Thread

Part Numbers	A	T	D	W	N	L	I
	Tube O.D. mm		mm	mm	mm	mm	mm
VUWH-2A	2	R 1/8	1.7	12	23.9	30.5	12.9
VUWH-3A	3	R 1/8	2.4	12	23.9	30.5	12.9
VUWH-3B	3	R 1/4	2.4	14	29	35.6	12.9
VUWH-4A	4	R 1/8	2.4	12	24.6	31.2	13.7
VUWH-4B	4	R 1/4	2.4	14	29.7	36.3	13.7
VUWH-6A	6	R 1/8	4.8	14	25.4	32.8	15.3
VUWH-6B	6	R 1/4	4.8	14	30.5	37.9	15.3
VUWH-6C	6	R 3/8	4.8	18	31	38.4	15.3
VUWH-6D	6	R 1/2	4.8	22	37.3	44.7	15.3
VUWH-8A	8	R 1/8	4.8	15	26.7	34.2	16.2
VUWH-8B	8	R 1/4	6.4	15	31.2	38.7	16.2
VUWH-8C	8	R 3/8	6.4	18	31.8	39.3	16.2
VUWH-8D	8	R 1/2	6.4	22	38.1	45.6	16.2
VUWH-10A	10	R 1/8	4.8	18	28.7	36.3	17.2
VUWH-10B	10	R 1/4	7.9	18	33.3	40.9	17.2
VUWH-10C	10	R 3/8	7.9	18	33.3	40.9	17.2
VUWH-10D	10	R 1/2	7.9	22	38.9	46.5	17.2
VUWH-12B	12	R 1/4	7.1	22	33.3	43.4	22.8
VUWH-12C	12	R 3/8	9.5	22	33.3	43.4	22.8
VUWH-12D	12	R 1/2	9.5	22	38.9	49	22.8
VUWH-12E	12	R 3/4	9.5	27	40.4	50.5	22.8
VUWH-15D	15	R 1/2	11.9	24	38.9	49	24.4
VUWH-16B	16	R 1/4	7.1	24	34	44.1	24.4
VUWH-16C	16	R 3/8	9.5	24	34	44.1	24.4
VUWH-16D	16	R 1/2	11.9	24	38.9	49	24.4
VUWH-16E	16	R 3/4	12.7	27	40.4	50.5	24.4
VUWH-18D	18	R 1/2	11.9	27	40.4	50.5	24.4
VUWH-18E	18	R 3/4	15.1	27	40.4	50.5	24.4
VUWH-20D	20	R 1/2	11.9	30	42.2	52.3	26
VUWH-20E	20	R 3/4	15.9	30	42.2	52.3	26
VUWH-22E	22	R 3/4	15.9	30	42.2	52.3	26
VUWH-22F	22	R 1	18.3	35	47	57.1	26
VUWH-25E	25	R 3/4	15.9	35	45.2	57.5	31.3
VUWH-25F	25	R 1	21.8	35	50	62.3	31.3

Reference Specifications:

DIN - ISO 2999
 BS - 21
 JIS - B0203
 ISO - 7/1-BSP-T

Designation:

R marking on hex.

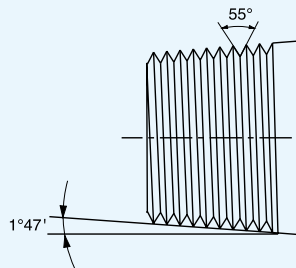

For inches, see next page

"D" - Dimension is minimum hole diameter - dimensions are for reference only, and are subject to change without notice.

Male Connectors (R) (continued)

H

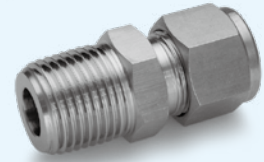
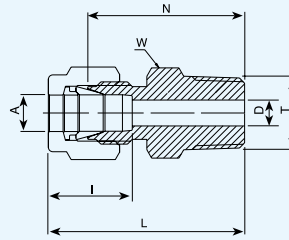

Tube (Inch) ISO Tapered Thread

Part Numbers	A Tube O.D.		T	D		W		N		L		I	
	in	mm		in	mm	in	mm	in	mm	in	mm	in	mm
VUWH-3.2A	1/8	3.2	R 1/8	0.09	2.3	7/16	11.1	0.94	23.9	1.2	30.5	0.5	12.7
VUWH-3.2B	1/8	3.2	R 1/4	0.09	2.3	9/16	14.3	1.14	29	1.4	35.6	0.5	12.7
VUWH-6.35A	1/4	6.35	R 1/8	0.19	4.8	1/2	12.7	1	25.4	1.29	32.8	0.6	15.2
VUWH-6.35B	1/4	6.35	R 1/4	0.19	4.8	9/16	14.3	1.2	30.5	1.49	37.8	0.6	15.2
VUWH-6.35C	1/4	6.35	R 3/8	0.19	4.8	11/16	17.5	1.22	31	1.51	38.4	0.6	15.2
VUWH-6.35D	1/4	6.35	R 1/2	0.19	4.8	7/8	22.2	1.47	37.3	1.76	44.7	0.6	15.2
VUWH-7.93A	5/16	7.93	R 1/8	0.19	4.8	9/16	14.3	1.05	26.7	1.34	34	0.64	16.2
VUWH-7.93B	5/16	7.93	R 1/4	0.25	6.35	9/16	14.3	1.23	31.2	1.52	38.6	0.64	16.2
VUWH-9.52A	3/8	9.52	R 1/8	0.19	4.8	5/8	15.9	1.1	27.9	1.39	35.3	0.66	16.8
VUWH-9.52B	3/8	9.52	R 1/4	0.28	7.1	5/8	15.9	1.28	32.5	1.57	39.9	0.66	16.8
VUWH-9.52C	3/8	9.52	R 3/8	0.28	7.1	11/16	17.5	1.28	32.5	1.57	39.9	0.66	16.8
VUWH-9.52D	3/8	9.52	R 1/2	0.28	7.1	7/8	22.2	1.53	38.9	1.82	46.2	0.66	16.8
VUWH-12.7B	1/2	12.7	R 1/4	0.28	7.1	13/16	20.6	1.31	33.3	1.71	43.4	0.9	22.9
VUWH-12.7C	1/2	12.7	R 3/8	0.38	9.6	13/16	20.6	1.31	33.3	1.71	43.4	0.9	22.9
VUWH-12.7D	1/2	12.7	R 1/2	0.41	10.4	7/8	22.2	1.53	38.9	1.93	49	0.9	22.9
VUWH-12.7E	1/2	12.7	R 3/4	0.41	10.4	1 1/16	27	1.59	40.4	1.99	50.5	0.9	22.9
VUWH-19.05E	3/4	19.05	R 3/4	0.62	15.8	1 1/16	27	1.59	40.4	1.99	50.5	0.96	24.4
VUWH-25.4F	1	25.4	R 1	0.88	22.3	1 3/8	34.9	1.97	50	2.45	62.2	1.23	31.2

"D" - Dimension is minimum hole diameter - dimensions are for reference only, and are subject to change without notice.

Male Connectors (G)

H

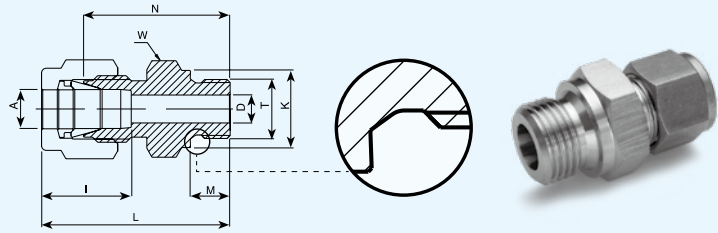

Tube (Metric) ISO Parallel Thread

Part Numbers	A	T	D	K	W	N	M	L	I
	Tube O.D. mm		mm	mm	mm	mm	mm	mm	mm
VUWH-2AF-FJS	2	G 1/8	1.7	13.8	14	23.4	7.1	30	12.9
VUWH-3AF-FJS	3	G 1/8	2.4	13.8	14	23.4	7.1	30	12.9
VUWH-3BF-FJS	3	G 1/4	2.4	18	19	28.7	11.2	35.3	12.9
VUWH-4AF-FJS	4	G 1/8	2.4	13.8	14	24.1	7.1	30.7	13.7
VUWH-6AF-FJS	6	G 1/8	4	13.8	14	24.9	7.1	32.3	15.3
VUWH-6BF-FJS	6	G 1/4	4.8	18	19	30.2	11.2	37.6	15.3
VUWH-6CF-FJS	6	G 3/8	4.8	21.8	22	31.5	11.2	38.9	15.3
VUWH-6DF-FJS	6	G 1/2	4.8	26	27	37.3	14.2	44.7	15.3
VUWH-8AF-FJS	8	G 1/8	4	13.8	15	25.7	7.1	33.2	16.2
VUWH-8BF-FJS	8	G 1/4	6.4	13.8	19	31	11.2	38.5	16.2
VUWH-8CF-FJS	8	G 3/8	6.4	21.8	22	32.3	11.2	39.8	16.2
VUWH-8DF-FJS	8	G 1/2	6.4	26	27	38.1	14.2	45.6	16.2
VUWH-10BF-FJS	10	G 1/4	5.9	18	19	31.8	11.2	39.4	17.2
VUWH-10CF-FJS	10	G 3/8	7.9	21.8	22	33	11.2	40.6	17.2
VUWH-10DF-FJS	10	G 1/2	7.9	26	27	38.9	14.2	46.5	17.2
VUWH-12BF-FJS	12	G 1/4	5.9	18	22	32.5	11.2	42.6	22.8
VUWH-12CF-FJS	12	G 3/8	7.9	21.8	22	33	11.2	43.1	22.8
VUWH-12DF-FJS	12	G 1/2	9.5	26	27	38.9	14.2	49	22.8
VUWH-12EF-FJS	12	G 3/4	9.5	32	35	42.7	15.7	52.8	22.8
VUWH-16CF-FJS	16	G 3/8	7.9	21.8	24	33.8	11.2	43.9	24.4
VUWH-16DF-FJS	16	G 1/2	11.9	26	27	38.9	14.2	49	24.4
VUWH-18DF-FJS	18	G 1/2	11.9	26	27	38.9	14.2	49	24.4
VUWH-18EF-FJS	18	G 3/4	15.1	32	35	42.7	15.7	52.8	24.4
VUWH-20DF-FJS	20	G 1/2	11.9	26	30	40.4	14.2	50.5	26
VUWH-20EF-FJS	20	G 3/4	15.9	32	35	42.7	15.7	52.8	26
VUWH-22EF-FJS	22	G 3/4	15.9	32	35	42.7	15.7	52.8	26
VUWH-22FF-FJS	22	G 1	18.3	39	41	45.2	18.3	55.3	26
VUWH-25EF-FJS	25	G 3/4	15.9	32	35	45.2	15.7	57.5	31.3
VUWH-25FF-FJS	25	G 1	19.8	39	41	47.8	18.3	60.1	31.3

For inches, see next page

Reference Specifications:

DIN - ISO 228/1
BS - 2779
JIS - B0202
ISO - 228/1-BSP-P

Designation:

G marking on hex.

Seal Method (Male G Thread Side)

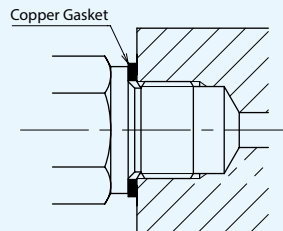

Note:

After checking G male thread size, please order a suitable gasket separately.

"D" - Dimension is minimum hole diameter - dimensions are for reference only, and are subject to change without notice.

Male Connectors (G) (continued)

H

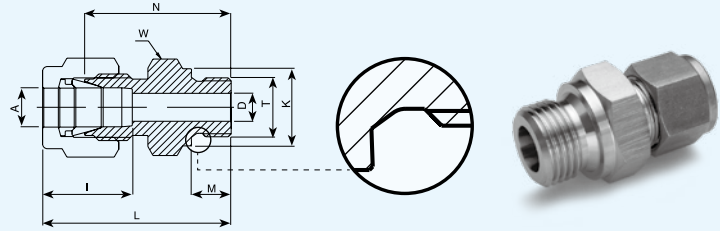

Tube (Inch) ISO Parallel Thread

Part Numbers	A Tube O.D.		T	D		K		W		N		M		L		I	
	in	mm		in	mm	in	mm	in	mm	in	mm	in	mm	in	mm	in	mm
VUWH-3.2AF-FJS	1/8	3.2	G 1/8	0.09	2.3	0.54	13.8	9/16	14.3	0.92	23.4	0.28	7.1	1.18	30	0.5	12.7
VUWH-3.2BF-FJS	1/8	3.2	G 1/4	0.09	2.3	0.71	18	3/4	19.1	1.13	28.7	0.44	11.2	1.39	35.3	0.5	12.7
VUWH-3.2CF-FJS	1/8	3.2	G 3/8	0.09	2.3	0.86	21.8	7/8	22.2	1.17	29.7	0.44	11.2	1.46	37	0.5	12.7
VUWH-3.2DF-FJS	1/8	3.2	G 1/2	0.09	2.3	1.02	26	1 1/16	27	1.4	35.7	0.56	14.2	1.69	43	0.5	12.7
VUWH-4.8AF-FJS	3/16	4.8	G 1/8	0.12	3.1	0.54	13.8	9/16	14.3	0.95	24.1	0.28	7.1	1.2	30.7	0.54	13.7
VUWH-6.35AF-FJS	1/4	6.35	G 1/8	0.16	4	0.54	13.8	9/16	14.3	0.98	24.9	0.28	7.1	1.27	32.3	0.6	15.2
VUWH-6.35BF-FJS	1/4	6.35	G 1/4	0.19	4.8	0.71	18	3/4	19.1	1.19	30.2	0.44	11.2	1.48	37.6	0.6	15.2
VUWH-6.35CF-FJS	1/4	6.35	G 3/8	0.19	4.8	0.86	21.8	7/8	22.2	1.24	31.5	0.44	11.2	1.53	38.9	0.6	15.2
VUWH-6.35DF-FJS	1/4	6.35	G 1/2	0.19	4.8	1.02	26	1 1/16	27	1.47	37.3	0.56	14.2	1.76	44.7	0.6	15.2
VUWH-7.93BF-FJS	5/16	7.93	G 1/4	0.25	6.4	0.71	18	3/4	19.1	1.22	31	0.44	11.2	1.51	38.4	0.63	16
VUWH-7.93CF-FJS	5/16	7.93	G 3/8	0.25	6.4	0.86	21.8	7/8	22.2	1.27	32.3	0.44	11.2	1.56	39.6	0.63	16
VUWH-9.52BF-FJS	3/8	9.52	G 1/4	0.23	5.8	0.71	18	3/4	19.1	1.25	31.8	0.44	11.2	1.54	39.1	0.66	16.8
VUWH-9.52CF-FJS	3/8	9.52	G 3/8	0.28	7.1	0.86	21.8	7/8	22.2	1.3	33	0.44	11.2	1.59	40.4	0.66	16.8
VUWH-9.52DF-FJS	3/8	9.52	G 1/2	0.28	7.1	1.02	26	1 1/16	27	1.53	38.9	0.56	14.2	1.82	46.3	0.66	16.8
VUWH-12.7BF-FJS	1/2	12.7	G 1/4	0.23	5.8	0.71	18	13/16	20.6	1.28	32.5	0.44	11.2	1.68	42.7	0.9	22.9
VUWH-12.7CF-FJS	1/2	12.7	G 3/8	0.31	7.9	0.86	21.8	7/8	22.2	1.3	33	0.44	11.2	1.7	43.2	0.9	22.9
VUWH-12.7DF-FJS	1/2	12.7	G 1/2	0.41	10.4	1.02	26	1 1/16	27	1.47	37.3	0.56	14.2	1.87	47.5	0.9	22.9
VUWH-12.7EF-FJS	1/2	12.7	G 3/4	0.41	10.4	1.26	32	1 5/16	33.3	1.68	42.7	0.62	15.7	2.08	52.8	0.9	22.9
VUWH-15.88CF-FJS	5/8	15.88	G 3/8	0.31	7.9	0.86	21.8	15/16	23.8	1.33	33.8	0.44	11.2	1.73	43.9	0.96	24.4
VUWH-15.88DF-FJS	5/8	15.88	G 1/2	0.47	11.9	1.02	26	1 1/16	27	1.53	38.9	0.56	14.2	1.93	49	0.96	24.4
VUWH-19.05DF-FJS	3/4	19.05	G 1/2	0.47	11.9	1.02	26	1 1/16	27	1.53	38.9	0.56	14.2	1.93	49	0.96	24.4
VUWH-19.05EF-FJS	3/4	19.05	G 3/4	0.62	15.7	1.26	32	1 5/16	33.3	1.68	42.7	0.62	15.7	2.08	52.8	0.96	24.4
VUWH-25.4DF-FJS	1	25.4	G 1/2	0.47	11.9	1.02	26	1 3/8	34.9	1.72	43.7	0.56	14.2	2.2	55.8	1.23	31.2
VUWH-25.4EF-FJS	1	25.4	G 3/4	0.62	15.9	1.26	32	1 3/8	34.9	1.78	45.2	0.62	15.7	2.65	67.3	1.23	31.2
VUWH-25.4FF-FJS	1	25.4	G 1	0.78	19.8	1.54	39	1 5/8	41.3	1.88	47.8	0.72	18.3	2.36	59.9	1.23	31.2

"D" - Dimension is minimum hole diameter - dimensions are for reference only, and are subject to change without notice.

Male Connectors (G)

H

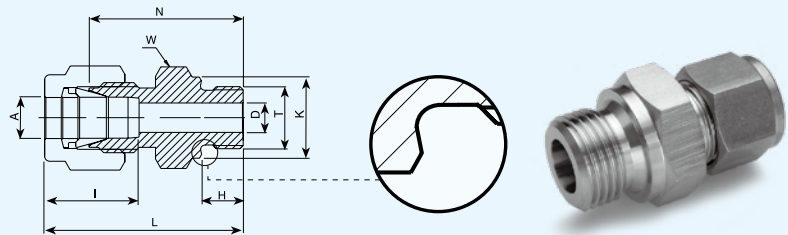

ISO Parallel Thread

Part Numbers	A	T	D	K	W	N	H	L	I
	Tube O.D. mm		mm	mm	mm	mm	mm	mm	mm
VUWH-3AF-FJT	3	G 1/8	2.4	13.8	14	23.4	7.1	30	12.9
VUWH-3BF-FJT	3	G 1/4	2.4	18	19	28.7	11.2	35.3	12.9
VUWH-4AF-FJT	4	G 1/8	2.4	13.8	14	24.1	7.1	30.7	13.7
VUWH-6AF-FJT	6	G 1/8	4	13.8	14	24.9	7.1	32.3	15.3
VUWH-6BF-FJT	6	G 1/4	4.8	18	19	30.2	11.2	37.6	15.3
VUWH-6CF-FJT	6	G 3/8	4.8	21.8	22	31.5	11.2	38.9	15.3
VUWH-6DF-FJT	6	G 1/2	4.8	26	27	37.3	14.2	44.7	15.3
VUWH-8AF-FJT	8	G 1/8	4	13.8	15	25.7	7.1	33.2	16.2
VUWH-8BF-FJT	8	G 1/4	6.4	18	19	31	11.2	38.5	16.2
VUWH-8CF-FJT	8	G 3/8	6.4	21.8	22	32.3	11.2	39.8	16.2
VUWH-8DF-FJT	8	G 1/2	6.4	26	27	38.1	14.2	45.6	16.2
VUWH-10BF-FJT	10	G 1/4	5.9	18	19	31.8	11.2	39.4	17.2
VUWH-10CF-FJT	10	G 3/8	7.9	21.8	22	33	11.2	40.6	17.2
VUWH-10DF-FJT	10	G 1/2	7.9	26	27	38.9	14.2	46.5	19.5
VUWH-12BF-FJT	12	G 1/4	5.9	18	22	32.5	11.2	42.6	17.2
VUWH-12CF-FJT	12	G 3/8	7.9	21.8	22	33	11.2	43.1	22.8
VUWH-12DF-FJT	12	G 1/2	9.5	26	27	38.9	14.2	49	22.8
VUWH-12EF-FJT	12	G 3/4	9.5	32	35	42.7	15.7	52.8	22.8
VUWH-15DF-FJT	15	G 1/2	11.9	26	27	38.9	14.2	49	22.8
VUWH-16CF-FJT	16	G 3/8	7.9	21.8	24	33.8	11.2	43.9	22.4
VUWH-16DF-FJT	16	G 1/2	11.9	26	27	38.9	14.2	49	22.4
VUWH-18DF-FJT	18	G 1/2	11.9	26	27	38.9	14.2	49	22.4
VUWH-18EF-FJT	18	G 3/4	15.1	32	35	42.7	15.7	52.8	22.4
VUWH-20DF-FJT	20	G 1/2	11.9	26	30	40.4	14.2	50.5	26
VUWH-20EF-FJT	20	G 3/4	15.9	32	35	42.7	15.7	52.8	26
VUWH-22EF-FJT	22	G 3/4	15.9	32	35	42.7	15.7	52.8	26
VUWH-22FF-FJT	22	G 1	18.3	39	40	45.2	18.3	55.3	26
VUWH-25EF-FJT	25	G 3/4	15.9	32	35	45.2	15.7	57.5	31.3
VUWH-25FF-FJT	25	G 1	19.8	39	40	47.8	18.3	60.1	31.3

Reference Specifications:

DIN - ISO 228/1
 BS - 2779
 JIS - B0202
 ISO - 228/1-BSP-P

Seal Method (Male G Thread Side)

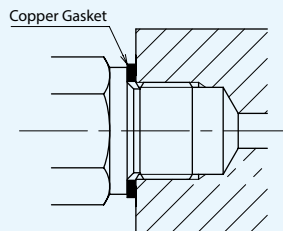

Note:

After checking G male thread size, please order a suitable gasket separately.

D - Dimension is minimum hole diameter - dimensions are for reference only, and are subject to change without notice.

Male Connectors (UNF)

H

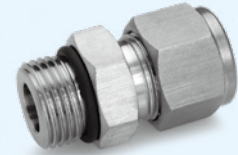
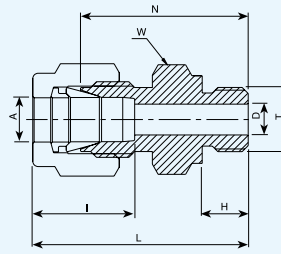

SAE/MS Straight Thread BOSS ※

Part Numbers	A Tube O.D.		T	D		W		N		H		L		I		O-ring ※※ size AS568
	in	mm		in	mm	in	mm	in	mm	in	mm	in	mm	in	mm	
VUWH-3.2X5/16	1/8	3.2	5/16-24	0.09	2.3	7/16	11.1	0.92	23.4	0.3	7.6	1.18	30	0.5	12.7	-902
VUWH-6.35X7/16	1/4	6.35	7/16-20	0.19	4.8	9/16	14.3	1.05	26.7	0.36	9.1	1.34	34	0.6	15.2	-904
VUWH-6.35X9/16	1/4	6.35	9/16-18	0.19	4.8	11/16	17.5	1.11	28.2	0.39	9.9	1.4	35.6	0.6	15.2	-906
VUWH-6.35X3/4	1/4	6.35	3/4-16	0.19	4.8	7/8	22.2	1.19	30.2	0.44	11.2	1.48	37.6	0.6	15.2	-908
VUWH-6.35X7/8	1/4	6.35	7/8-14	0.19	4.8	1	25.4	1.31	33.3	0.5	12.7	1.6	40.6	0.6	15.2	-910
VUWH-7.93X1/2	5/16	7.93	1/2-20	0.25	6.4	5/8	15.9	1.08	27.4	0.36	9.1	1.37	34.8	0.64	16.2	-905
VUWH-9.52X7/16	3/8	9.52	7/16-20	0.2	5.1	5/8	15.9	1.11	28.2	0.36	9.1	1.4	35.6	0.66	16.8	-904
VUWH-9.52X9/16	3/8	9.52	9/16-18	0.28	7.1	11/16	17.5	1.17	29.7	0.39	9.9	1.46	37.1	0.66	16.8	-906
VUWH-9.52X3/4	3/8	9.52	3/4-16	0.28	7.1	7/8	22.2	1.25	31.8	0.44	11.2	1.54	39.1	0.66	16.8	-908
VUWH-9.52X7/8	3/8	9.52	7/8-14	0.28	7.1	1	25.4	1.37	34.8	0.5	12.7	1.66	42.2	0.66	16.8	-910
VUWH-12.7X9/16	1/2	12.7	9/16-18	0.28	7.1	13/16	20.6	1.14	29	0.39	9.9	1.54	39.1	0.9	22.9	-906
VUWH-12.7X3/4	1/2	12.7	3/4-16	0.41	10.4	7/8	22.2	1.25	31.8	0.44	11.2	1.65	41.9	0.9	22.9	-908
VUWH-12.7X7/8	1/2	12.7	7/8-14	0.41	10.4	1	25.4	1.37	34.8	0.5	12.7	1.77	45	0.9	22.9	-910
VUWH-12.7X1-1/16	1/2	12.7	1 1/16-12	0.41	10.4	1 1/4	31.8	1.53	38.9	0.59	15	1.93	49	0.9	22.9	-912
VUWH-15.88X3/4	5/8	15.88	3/4-16	0.42	10.7	15/16	23.8	1.25	31.8	0.44	11.2	1.65	41.9	0.96	22.4	-908
VUWH-15.88X7/8	5/8	15.88	7/8-14	0.5	12.7	1	25.4	1.38	35	0.5	12.7	1.78	45.2	0.96	22.4	-910
VUWH-19.05X3/4	3/4	19.05	3/4-16	0.42	10.7	1 1/16	27	1.41	35.8	0.44	11.2	1.81	46	0.96	22.4	-908
VUWH-19.05X1-1/16	3/4	19.05	1 1/16-12	0.62	15.8	1 1/4	31.8	1.53	38.9	0.59	15	1.93	49	0.96	22.4	-912
VUWH-22.22X1-3/16	7/8	22.22	1 3/16-12	0.72	18.3	1 3/8	34.9	1.53	38.9	0.59	15	1.93	49	1.02	25.9	-914
VUWH-25.4X1-1/16	1	25.4	1 1/16-12	0.66	16.8	1 3/8	34.9	1.62	41.1	0.59	15	2.1	53.3	1.23	31.2	-912
VUWH-25.4X1-5/16	1	25.4	1 5/16-12	0.88	22.3	1 1/2	38.1	1.66	42.2	0.59	15	2.14	54.4	1.23	31.2	-916

※ : Per SAE J1926 and MS 16142. See page 78 for mounting dimensions.

※※ : O-rings used are Viton 90 Durometer. Other O-ring materials are available on request.

"D" - Dimension is minimum hole diameter - dimensions are for reference only, and are subject to change without notice.

Male Connectors

H

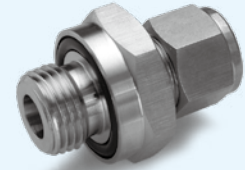
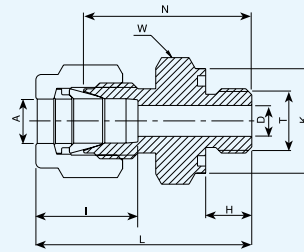

O-Seal NPT Tapered Thread

Part Numbers	A Tube O.D.		T	D		K		W		N		H		L		I		O-ring ※※ size AS568
	in	mm		in	mm	in	mm	in	mm	in	mm	in	mm	in	mm	in	mm	
VUWH-3.2AN-OR	1/8	3.2	1/8NPT	0.09	2.3	0.74	18.8	3/4	19.1	1.03	26.2	0.28	7.1	1.29	32.8	0.5	12.7	-111
VUWH-6.35AN-OR	1/4	6.35	1/8NPT	0.19	4.8	0.74	18.8	3/4	19.1	1.09	27.7	0.28	7.1	1.38	35.1	0.6	15.2	-111
VUWH-6.35BN-OR	1/4	6.35	1/4NPT	0.19	4.8	0.93	23.6	15/16	23.8	1.22	31	0.38	9.7	1.51	38.4	0.6	15.2	-113
VUWH-9.52BN-OR	3/8	9.52	1/4NPT	0.28	7.1	0.93	23.6	15/16	23.8	1.28	32.5	0.38	9.7	1.57	39.9	0.66	16.8	-113
VUWH-9.52CN-OR	3/8	9.52	3/8NPT	0.28	7.1	1.12	28.4	1 1/8	28.6	1.34	34	0.41	10.4	1.63	41.4	0.66	16.8	-116
VUWH-9.52DN-OR	3/8	9.52	1/2NPT	0.28	7.1	1.3	33	1 5/16	33.3	1.56	39.6	0.53	13.5	1.85	47	0.66	16.8	-212
VUWH-12.7DN-OR	1/2	12.7	1/2NPT	0.41	10.4	1.3	33	1 5/16	33.3	1.56	39.6	0.53	13.5	1.96	49.8	0.9	22.9	-212

Male Connectors

H

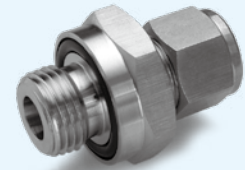
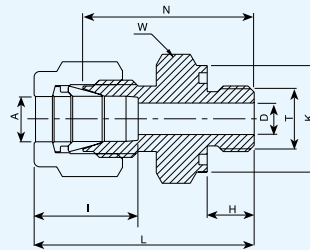

O-Seal Male UNF Thread

Part Numbers	A Tube O.D.		T	D		K		W		N		H		L		I		O-ring ※※ size AS568
	in	mm		in	mm	in	mm	in	mm	in	mm	in	mm	in	mm	in	mm	
VUWH-1.6X5/16-OR	1/16	1.6	5/16-24	0.05	1.3	0.55	14	9/16	14.3	0.9	22.9	0.34	8.6	1.05	26.7	0.34	8.6	-011
VUWH-3.2X5/16-OR	1/8	3.2	5/16-24	0.09	2.3	0.55	14	9/16	14.3	1.03	26.2	0.34	8.6	1.29	32.8	0.5	12.7	-011
VUWH-4.8X3/8-OR	3/16	4.8	3/8-24	0.12	3	0.62	15.7	5/8	15.9	1.09	27.7	0.38	9.7	1.35	34.3	0.54	13.7	-012
VUWH-6.35X7/16-OR	1/4	6.35	7/16-20	0.19	4.8	0.74	18.8	3/4	19.1	1.22	31	0.41	10.4	1.51	38.4	0.6	15.2	-111
VUWH-7.93X1/2-OR	5/16	7.93	1/2-20	0.25	6.35	0.86	21.8	7/8	22.2	1.31	33.3	0.44	11.2	1.6	40.6	0.64	16.3	-112
VUWH-9.52X9/16-OR	3/8	9.52	9/16-18	0.28	7.1	0.93	23.6	15/16	23.8	1.38	35.1	0.47	11.9	1.67	42.4	0.66	16.8	-113
VUWH-12.7X3/4-OR	1/2	12.7	3/4-16	0.41	10.4	1.12	28.4	1 1/8	28.6	1.41	35.8	0.47	11.9	1.81	46	0.9	22.9	-116
VUWH-19.05X1-1/16-OR	3/4	19.05	1 1/16-12	0.62	15.7	1.49	37.8	1 1/2	38.1	1.66	42.2	0.56	14.2	2.06	52.3	0.96	24.4	-215
VUWH-25.4X1-5/16-OR	1	25.4	1 5/16-12	0.88	22.3	1.74	44.2	1 3/4	44.5	1.81	46	0.56	14.2	2.29	58.2	1.23	31.2	-219

※※ : O-rings used are BUNA 70 Durometer.

"D" - Dimension is minimum hole diameter - dimensions are for reference only, and are subject to change without notice.

Male Pipe Weld Connectors

R

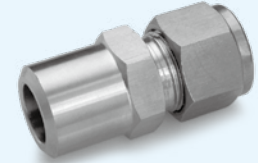
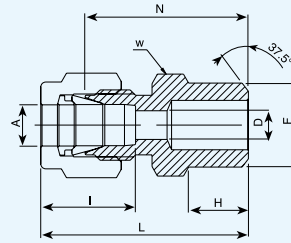

Tube (Metric)

Part Numbers	A Tube O.D.		F Tube size		D		W		N		H		L		I	
	mm	in	mm	in	mm	in	mm	in	mm	in	mm	in	mm	in	mm	in
VUWR-3x10.3	3	1/8	10.3		2.4		12		23.9		9.7		30.5		12.9	
VUWR-4x10.3	4	1/8	10.3		2.4		12		24.1		9.7		31.2		13.7	
VUWR-6x10.3	6	1/8	10.3		4.8		14		25.4		9.7		32.8		15.3	
VUWR-6x13.7	6	1/4	13.7		4.8		14		30.5		14.2		37.9		15.3	
VUWR-8x10.3	8	1/8	10.3		5.1		15		26.7		9.7		34.2		16.2	
VUWR-8x13.7	8	1/4	13.7		6.4		15		31.2		14.2		38.7		16.2	
VUWR-8x21.3	8	1/2	21.3		6.4		22		37.3		19		45.6		16.2	
VUWR-10x13.7	10	1/4	13.7		7.1		18		33.3		14.2		40.9		17.2	
VUWR-10x17.1	10	3/8	17.1		7.9		18		33.3		14.2		40.9		17.2	
VUWR-10x21.3	10	1/2	21.3		7.9		22		38.9		19		46.5		17.2	
VUWR-12x13.7	12	1/4	13.7		7.1		22		33.3		14.2		43.4		22.8	
VUWR-12x17.1	12	3/8	17.1		9.5		22		33.3		14.2		43.4		22.8	
VUWR-12x21.3	12	1/2	21.3		9.5		22		38.9		19		49		22.8	
VUWR-15x21.3	15	1/2	21.3		11.9		24		38.9		19		49		24.4	
VUWR-16x21.3	16	1/2	21.3		12.7		24		38.9		19		49		24.4	
VUWR-18x21.3	18	1/2	21.3		13.5		27		40.4		19		50.5		24.4	

Tube (Inch)

Part Numbers	A Tube O.D.		F Tube size		D		W		N		H		L		I	
	in	mm	in	mm	in	mm	in	mm	in	mm	in	mm	in	mm	in	mm
VUWR-3.2x10.3	1/8	3.2	1/8	10.3	0.09	2.3	7/16	11.1	0.94	23.9	0.38	9.7	1.2	30.5	0.5	12.7
VUWR-4.8x10.3	3/16	4.8	1/8	10.3	0.12	3.1	7/16	11.1	0.97	24.6	0.38	9.7	1.23	31.2	0.54	13.7
VUWR-6.35x10.3	1/4	6.35	1/8	10.3	0.19	4.8	1/2	12.7	1	25.4	0.38	9.7	1.29	32.8	0.6	15.2
VUWR-6.35x13.7	1/4	6.35	1/4	13.7	0.19	4.8	9/16	14.3	1.2	30.5	0.56	14.2	1.49	37.8	0.6	15.2
VUWR-7.93x10.3	5/16	7.93	1/8	10.3	0.2	5.1	9/16	14.3	1.05	26.7	0.38	9.65	1.34	34	0.64	16.3
VUWR-7.93x13.7	5/16	7.93	1/4	13.7	0.25	6.35	9/16	14.3	1.23	31.2	0.56	14.2	1.52	38.6	0.64	16.3
VUWR-9.52x13.7	3/8	9.52	1/4	13.7	0.28	7.1	5/8	15.9	1.28	32.5	0.56	14.2	1.57	39.9	0.66	16.8
VUWR-9.52x17.1	3/8	9.52	3/8	17.1	0.28	7.1	11/16	17.5	1.28	32.5	0.56	14.2	1.57	39.9	0.66	16.8
VUWR-9.52x21.3	3/8	9.52	1/2	21.3	0.28	7.1	7/8	22.2	1.53	38.9	0.75	19	1.82	46.2	0.66	16.8
VUWR-12.7x17.1	1/2	12.7	3/8	17.1	0.41	10.4	13/16	20.6	1.31	33.3	0.56	14.2	1.71	44.4	0.9	22.9
VUWR-12.7x21.3	1/2	12.7	1/2	21.3	0.41	10.4	7/8	22.2	1.53	38.9	0.75	19	1.93	49	0.9	22.9
VUWR-12.7x26.7	1/2	12.7	3/4	26.7	0.41	10.4	1 1/16	27	1.59	40.4	0.75	19	1.99	50.5	0.9	22.9
VUWR-15.88x21.3	5/8	15.88	1/2	21.3	0.5	12.7	15/16	23.8	1.53	38.9	0.75	19	1.93	49	0.96	24.4
VUWR-19.05x26.7	3/4	19.05	3/4	26.7	0.62	15.8	1 1/16	27	1.59	40.4	0.75	19	1.99	50.5	0.96	24.4
VUWR-25.4x33.4	1	25.4	1	33.4	0.88	22.4	1 3/8	34.9	1.97	50	0.94	23.9	2.45	62.2	1.23	31.2

"D" - Dimension is minimum hole diameter - dimensions are for reference only, and are subject to change without notice.

Tube Socket Weld Unions

R

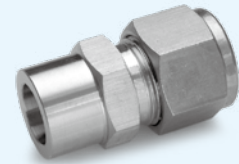
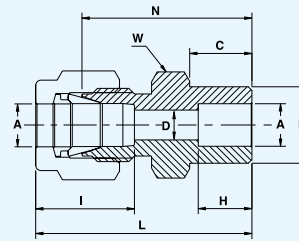

Tube (Inch)

Part Numbers	A		D		W		N		F		C		H		L		I	
	Tube O.D.																	
	in	mm	in	mm	in	mm	in	mm	in	mm	in	mm	in	mm	in	mm	in	mm
VUWR-3.2X3.2F	1/8	3.2	0.09	2.3	7/16	11.1	0.88	22.4	0.31	7.8	0.34	8.6	0.25	6.35	1.14	29	0.5	12.7
VUWR-6.35X6.35F	1/4	6.35	0.19	4.8	1/2	12.7	1.03	26.2	0.44	11.2	0.41	10.4	0.31	7.9	1.32	33.5	0.6	15.2
VUWR-9.52X9.52F	3/8	9.52	0.28	7.1	5/8	15.9	1.19	30.2	0.62	15.8	0.47	11.9	0.38	9.65	1.48	37.6	0.66	16.8
VUWR-12.7X12.7F	1/2	12.7	0.41	10.4	13/16	20.6	1.26	32	0.75	19.05	0.47	11.9	0.5	12.7	1.62	41.1	0.9	22.9
VUWR-19.05X19.05F	3/4	19.05	0.62	15.8	1 1/16	27	1.31	33.3	1.05	26.7	0.47	11.9	0.56	14.2	1.71	43.4	0.96	24.4
VUWR-25.4X25.4F	1	25.4	0.88	22.3	1 3/8	34.9	1.59	40.4	1.31	33.3	0.56	14.2	0.76	19.2	2.07	52.6	1.23	31.2

Flange Unions

RF

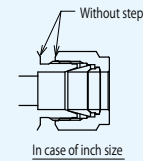
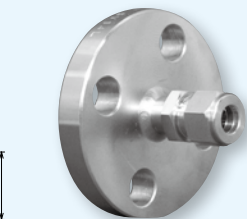
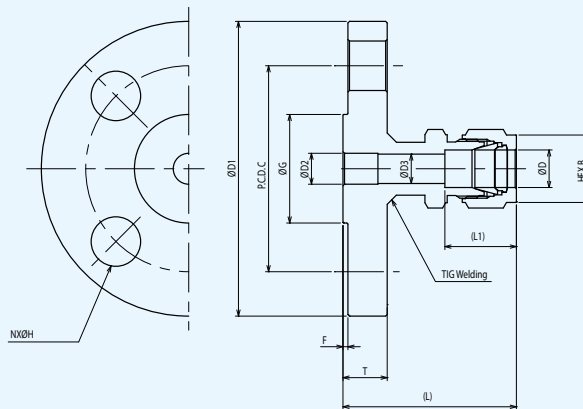

Part Numbers	Connection Flange Standard	Nominal Diameter		Dimensions inch (mm)												
		Fittings inch (mm)	Flanges (A)	L	L1	Flange								D2	D3	B
						D1	T	F	G	Bolt Holes						
										C	N	H				
VUWRF-12D-J10R	JIS 10K	- (12)	15	2.1 (53.4)	0.9 (22.8)	3.74 (95)	0.47 (12)	0.039 (1)	2.01 (51)	2.76 (70)	4	0.59 (15)	0.39 (10)	0.37 (9.5)	0.87 (22)	
VUWRF-12D-J20R	JIS 20K	- (12)	15	2.18 (55.4)	0.9 (22.8)	3.74 (95)	0.47 (14)	0.039 (1)	2.01 (51)	2.76 (70)	4	0.59 (15)	0.39 (10)	0.37 (9.5)	0.87 (22)	
VUWRF-12D-A2R	ANSI 150	- (12)	15	2.07 (52.6)	0.9 (22.8)	3.5 (88.9)	0.44 (11.2)	0.063 (1.6)	1.38 (35.1)	2.38 (60.5)	4	0.63 (16)	0.39 (10)	0.37 (9.5)	0.87 (22)	
VUWRF-12.7D-A2R		1/2 (12.7)	15	2.07 (52.6)	0.9 (22.9)											
VUWRF-12.7F-A2R		1/2 (12.7)	25	2.19 (55.7)	0.9 (22.9)	4.25 (108)	0.56 (14.3)	0.063 (1.6)	2 (50.8)	3.12 (79.3)	4	0.63 (16)	0.39 (10)	0.37 (9.5)	0.87 (22.2)	
VUWRF-12D-A3R	ANSI 300	- (12)	15	2.19 (55.7)	0.9 (22.8)	3.75 (95.3)	0.56 (14.3)	0.063 (1.6)	1.38 (35.1)	2.62 (66.6)	4	0.63 (16)	0.39 (10)	0.37 (9.5)	0.87 (22)	
VUWRF-12.7D-A3R		1/2 (12.7)	15	2.19 (55.7)	0.9 (22.9)											
VUWRF-12.7F-A3R		1/2 (12.7)	25	2.32 (59)	0.9 (22.9)	4.88 (124)	0.69 (17.6)	0.063 (1.6)	2 (50.8)	3.5 (88.9)	4	0.77 (19.5)	0.39 (10)	0.37 (9.5)	0.87 (22.2)	

"D" - Dimension is minimum hole diameter - dimensions are for reference only, and are subject to change without notice.

Male Elbows

L

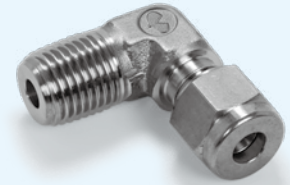
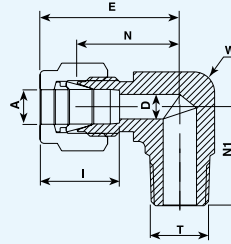

Tube (Metric) Male NPT Thread

Part Numbers	A	T	D	W		N	E	N1	I
	Tube O.D. mm		mm	in	mm	mm	mm	mm	mm
VUWL-3AN	3	1/8NPT	2.4	7/16	11.1	17	23.6	17.8	12.9
VUWL-3BN	3	1/4NPT	2.4	1/2	12.7	18	24.6	23.4	12.9
VUWL-4AN	4	1/8NPT	2.4	1/2	12.7	18.8	25.4	18.8	13.7
VUWL-4BN	4	1/4NPT	2.4	1/2	12.7	18.8	25.4	23.4	13.7
VUWL-6AN	6	1/8NPT	4.8	1/2	12.7	19.6	27	18.8	15.3
VUWL-6BN	6	1/4NPT	4.8	1/2	12.7	19.6	27	23.4	15.3
VUWL-6CN	6	3/8NPT	4.8	11/16	17.5	22.4	29.8	26.2	15.3
VUWL-6DN	6	1/2NPT	4.8	13/16	20.6	24.4	31.8	33	15.3
VUWL-8AN	8	1/8NPT	4.8	9/16	14.3	21.3	28.8	19.8	16.2
VUWL-8BN	8	1/4NPT	6.4	9/16	14.3	21.3	28.8	24.4	16.2
VUWL-8CN	8	3/8NPT	6.4	11/16	17.5	23.1	30.6	26.2	16.2
VUWL-8DN	8	1/2NPT	6.4	13/16	20.6	25.1	32.6	33	16.2
VUWL-10AN	10	1/8NPT	4.8	11/16	17.5	23.9	31.5	21.6	17.2
VUWL-10BN	10	1/4NPT	7.1	11/16	17.5	23.9	31.5	26.2	17.2
VUWL-10CN	10	3/8NPT	7.9	11/16	17.5	23.9	31.5	26.2	17.2
VUWL-10DN	10	1/2NPT	7.9	13/16	20.6	25.9	33.5	33	17.2
VUWL-12AN	12	1/8NPT	4.8	13/16	20.6	25.9	36	23.6	22.8
VUWL-12BN	12	1/4NPT	7.1	13/16	20.6	25.9	36	28.2	22.8
VUWL-12CN	12	3/8NPT	9.5	13/16	20.6	25.9	36	28.2	22.8
VUWL-12DN	12	1/2NPT	9.5	13/16	20.6	25.9	36	33	22.8
VUWL-12EN	12	3/4NPT	9.5	1 1/8	28.6	29.7	39.8	36.8	22.8
VUWL-15DN	15	1/2NPT	11.9	15/16	23.8	27.9	38	35.1	24.4
VUWL-16CN	16	3/8NPT	9.5	15/16	23.8	27.9	38	30.2	24.4
VUWL-16DN	16	1/2NPT	11.9	15/16	23.8	27.9	38	35.1	24.4
VUWL-16EN	16	3/4NPT	12.7	1 1/8	28.6	29.7	39.8	36.8	24.4
VUWL-18DN	18	1/2NPT	11.9	1 1/8	28.6	29.7	39.8	36.8	24.4
VUWL-18EN	18	3/4NPT	15.1	1 1/8	28.6	29.7	39.8	36.8	24.4
VUWL-20DN	20	1/2NPT	11.9	1 3/8	34.9	34.5	44.6	41.7	26
VUWL-20EN	20	3/4NPT	15.9	1 3/8	34.9	34.5	44.6	41.7	26
VUWL-22EN	22	3/4NPT	15.9	1 3/8	34.9	34.5	44.6	41.7	26
VUWL-22FN	22	1NPT	18.3	1 3/8	34.9	34.5	44.6	46.5	26
VUWL-25EN	25	3/4NPT	15.9	1 3/8	34.9	36.8	49.1	41.7	31.3
VUWL-25FN	25	1NPT	21.8	1 3/8	34.9	36.8	49.1	46.5	31.3

For inches, see next page

"D" - Dimension is minimum hole diameter - dimensions are for reference only, and are subject to change without notice.

Male Elbows (continued)

L

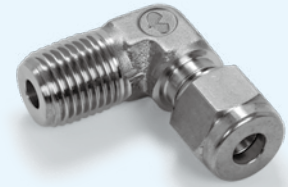
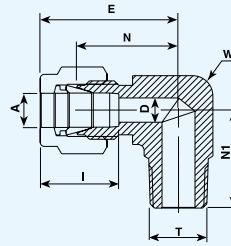

V-Lok Tube Fittings Male Elbows (continued)

Tube (Inch) Male NPT Thread

Part Numbers	A Tube O.D.		T	D		W		N		E		N1		I	
	in	mm		in	mm	in	mm	in	mm	in	mm	in	mm	in	mm
VUWL-1.6AN	1/16	1.6	1/8NPT	0.05	1.3	7/16	11.1	0.6	15.2	0.75	19.1	0.7	17.8	0.34	8.6
VUWL-3,2AN	1/8	3.2	1/8NPT	0.09	2.3	7/16	11.1	0.67	17	0.93	23.6	0.7	17.8	0.5	12.7
VUWL-3,2BN	1/8	3.2	1/4NPT	0.09	2.3	1/2	12.7	0.71	18	0.97	24.6	0.92	23.4	0.5	12.7
VUWL-4.8AN	3/16	4.8	1/8NPT	0.12	3	1/2	12.7	0.74	18.8	1	25.4	0.74	18.8	0.54	13.7
VUWL-4.8BN	3/16	4.8	1/4NPT	0.12	3	1/2	12.7	0.74	18.8	1	25.4	0.92	23.4	0.54	13.7
VUWL-6.35AN	1/4	6.35	1/8NPT	0.19	4.8	1/2	12.7	0.77	19.6	1.06	26.9	0.74	18.8	0.6	15.2
VUWL-6.35BN	1/4	6.35	1/4NPT	0.19	4.8	1/2	12.7	0.77	19.6	1.06	26.9	0.92	23.4	0.6	15.2
VUWL-6.35CN	1/4	6.35	3/8NPT	0.19	4.8	11/16	17.5	0.88	22.4	1.17	29.7	1.03	26.2	0.6	15.2
VUWL-6.35DN	1/4	6.35	1/2NPT	0.19	4.8	13/16	20.6	0.96	24.4	1.25	31.8	1.3	33	0.6	15.2
VUWL-7,93AN	5/16	7.93	1/8NPT	0.19	4.8	9/16	14.3	0.84	21.3	1.13	28.7	0.78	19.8	0.64	16.2
VUWL-7,93BN	5/16	7.93	1/4NPT	0.25	6.4	9/16	14.3	0.84	21.3	1.13	28.7	0.96	24.4	0.64	16.2
VUWL-7,93CN	5/16	7.93	3/8NPT	0.25	6.4	11/16	17.5	0.91	23.1	1.2	30.5	1.03	26.2	0.64	16.2
VUWL-9,52AN	3/8	9.52	1/8NPT	0.19	4.8	5/8	15.9	0.91	23.1	1.2	30.5	0.82	20.8	0.66	16.8
VUWL-9,52BN	3/8	9.52	1/4NPT	0.28	7.1	5/8	15.9	0.91	23.1	1.2	30.5	1	25.4	0.66	16.8
VUWL-9,52CN	3/8	9.52	3/8NPT	0.28	7.1	11/16	17.5	0.94	23.9	1.23	31.2	1.03	26.2	0.66	16.8
VUWL-9,52DN	3/8	9.52	1/2NPT	0.28	7.1	13/16	20.6	1.02	25.9	1.31	33.3	1.3	33	0.66	16.8
VUWL-9,52EN	3/8	9.52	3/4NPT	0.28	7.1	1 1/16	27	1.17	29.7	1.46	37.1	1.45	36.8	0.66	16.8
VUWL-12,7BN	1/2	12.7	1/4NPT	0.28	7.1	13/16	20.6	1.02	25.9	1.42	36.1	1.11	28.2	0.9	22.9
VUWL-12,7CN	1/2	12.7	3/8NPT	0.37	9.5	13/16	20.6	1.02	25.9	1.42	36.1	1.11	28.2	0.9	22.9
VUWL-12,7DN	1/2	12.7	1/2NPT	0.41	10.4	13/16	20.6	1.02	25.9	1.42	36.1	1.3	33	0.9	22.9
VUWL-12,7EN	1/2	12.7	3/4NPT	0.41	10.4	1 1/16	27	1.17	29.7	1.57	39.9	1.45	36.8	0.9	22.9
VUWL-15,88CN	5/8	15.88	3/8NPT	0.37	9.6	15/16	23.8	1.1	27.9	1.5	38.1	1.19	30.2	0.96	24.4
VUWL-15,88DN	5/8	15.88	1/2NPT	0.47	11.9	15/16	23.8	1.1	27.9	1.5	38.1	1.38	35.1	0.96	24.4
VUWL-15,88EN	5/8	15.88	3/4NPT	0.50	12.7	1 1/8	28.6	1.17	29.7	1.57	39.9	1.45	36.8	0.96	24.4
VUWL-19,05DN	3/4	19.05	1/2NPT	0.47	11.9	1 1/16	27	1.17	29.7	1.57	39.9	1.45	36.8	0.96	24.4
VUWL-19,05EN	3/4	19.05	3/4NPT	0.62	15.8	1 1/16	27	1.17	29.7	1.57	39.9	1.45	36.8	0.96	24.4
VUWL-22,22EN	7/8	22.22	3/4NPT	0.62	15.8	1 3/8	34.9	1.36	34.5	1.76	44.7	1.64	41.7	1.02	25.9
VUWL-25,4EN	1	25.4	3/4NPT	0.62	15.8	1 3/8	34.9	1.45	36.8	1.93	49	1.64	41.7	1.23	31.2
VUWL-25,4FN	1	25.4	1NPT	0.86	21.8	1 3/8	34.9	1.45	36.8	1.93	49	1.83	46.5	1.23	31.2

"D" - Dimension is minimum hole diameter - dimensions are for reference only, and are subject to change without notice.

Male Elbows

L

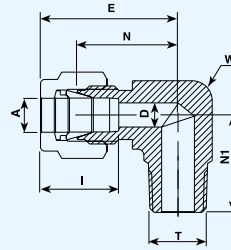

Tube (Metric) ISO Tapered Thread

Part Numbers	A	T	D	W		N	E	N ₁	I
	Tube O.D. mm		mm	in	mm	mm	mm	mm	mm
VUWL-3A	3	R 1/8	2.4	7/16	11.1	17	23.6	17.8	12.9
VUWL-3B	3	R 1/4	2.4	1/2	12.7	18	24.6	23.4	12.9
VUWL-4A	4	R 1/8	2.4	1/2	12.7	18.8	25.4	18.8	13.7
VUWL-4B	4	R 1/4	2.4	1/2	12.7	18.8	25.4	23.4	13.7
VUWL-6A	6	R 1/8	4.8	1/2	12.7	19.6	27	18.8	15.3
VUWL-6B	6	R 1/4	4.8	1/2	12.7	19.6	27	23.4	15.3
VUWL-6C	6	R 3/8	4.8	11/16	17.5	22.4	29.8	26.2	15.3
VUWL-6D	6	R 1/2	4.8	13/16	20.6	24.4	31.8	33	15.3
VUWL-8A	8	R 1/8	4.8	9/16	14.3	21.3	28.8	19.8	16.2
VUWL-8B	8	R 1/4	6.4	9/16	14.3	21.3	28.8	24.4	16.2
VUWL-8C	8	R 3/8	6.4	11/16	17.5	23.1	30.6	26.2	16.2
VUWL-8D	8	R 1/2	6.4	13/16	20.6	25.1	32.6	33	16.2
VUWL-10A	10	R 1/8	4.8	11/16	17.5	23.9	31.5	21.6	17.2
VUWL-10B	10	R 1/4	7.1	11/16	17.5	23.9	31.5	26.2	17.2
VUWL-10C	10	R 3/8	7.9	11/16	17.5	23.9	31.5	26.2	17.2
VUWL-10D	10	R 1/2	7.9	13/16	20.6	25.9	33.5	33	17.2
VUWL-12A	12	R 1/8	4.8	13/16	20.6	25.9	36	23.6	22.8
VUWL-12B	12	R 1/4	7.1	13/16	20.6	25.9	36	28.2	22.8
VUWL-12C	12	R 3/8	9.5	13/16	20.6	25.9	36	28.2	22.8
VUWL-12D	12	R 1/2	9.5	13/16	20.6	25.9	36	33	22.8
VUWL-12E	12	R 3/4	9.5	1 1/16	27	29.7	39.8	36.8	22.8
VUWL-16C	16	R 3/8	9.5	15/16	23.8	27.9	38	30.2	24.4
VUWL-16D	16	R 1/2	11.9	15/16	23.8	27.9	38	35.1	24.4
VUWL-18D	18	R 1/2	11.9	1 1/8	28.6	29.7	39.8	36.8	24.4
VUWL-18E	18	R 3/4	15.1	1 1/16	27	29.7	39.8	36.8	24.4
VUWL-20D	20	R 1/2	11.9	1 3/8	34.9	34.5	44.6	41.7	26
VUWL-20E	20	R 3/4	15.9	1 3/8	34.9	34.5	44.6	41.7	26
VUWL-22E	22	R 3/4	15.9	1 3/8	34.9	34.5	44.6	41.7	26
VUWL-22F	22	R 1	18.3	1 3/8	34.9	34.5	44.6	46.5	26
VUWL-25E	25	R 3/4	15.9	1 3/8	34.9	36.8	49.1	41.7	31.3
VUWL-25F	25	R 1	21.8	1 3/8	34.9	36.8	49.1	46.5	31.3

Reference Specifications:

- DIN - 2999
- BS - 21
- JIS - B0203
- ISO - 1/7-BSP-T

Designation:

R marking on hex.

"D" - Dimension is minimum hole diameter - dimensions are for reference only, and are subject to change without notice.

Male Elbows (R)

L

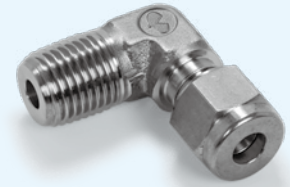
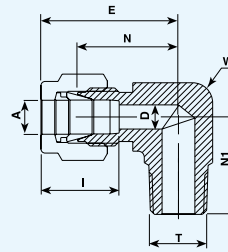

Tube (Inch) To ISO Tapered Thread

Part Numbers	A Tube O.D.		T	D		W		N		E		N ₁		I	
	in	mm		in	mm	in	mm	in	mm	in	mm	in	mm	in	mm
VUWL-1.6A	1/16	1.6	R 1/8	0.05	1.3	7/16	11.1	0.6	15.2	0.75	19.1	0.7	17.8	0.34	8.6
VUWL-3,2A	1/8	3.2	R 1/8	0.09	2.3	7/16	11.1	0.67	17	0.93	23.6	0.7	17.8	0.5	12.7
VUWL-3,2B	1/8	3.2	R 1/4	0.09	2.3	1/2	12.7	0.71	18	0.97	24.6	0.92	23.4	0.5	12.7
VUWL-4.8A	3/16	4.8	R 1/8	0.12	3	1/2	12.7	0.74	18.8	1	25.4	0.74	18.8	0.54	13.7
VUWL-4.8B	3/16	4.8	R 1/4	0.12	3	1/2	12.7	0.74	18.8	1	25.4	0.92	23.4	0.54	13.7
VUWL-6.35A	1/4	6.35	R 1/8	0.19	4.8	1/2	12.7	0.77	19.6	1.06	26.9	0.74	18.8	0.6	15.2
VUWL-6.35B	1/4	6.35	R 1/4	0.19	4.8	1/2	12.7	0.77	19.6	1.06	26.9	0.92	23.4	0.6	15.2
VUWL-6.35C	1/4	6.35	R 3/8	0.19	4.8	11/16	17.5	0.88	22.4	1.17	29.7	1.03	26.2	0.6	15.2
VUWL-6.35D	1/4	6.35	R 1/2	0.19	4.8	13/16	20.6	0.96	24.4	1.25	31.8	1.3	33	0.6	15.2
VUWL-7.93A	5/16	7.93	R 1/8	0.19	4.8	9/16	14.3	0.84	21.3	1.13	28.7	0.78	19.8	0.64	16.2
VUWL-7.93B	5/16	7.93	R 1/4	0.25	6.35	9/16	14.3	0.84	21.3	1.13	28.7	0.96	24.4	0.64	16.2
VUWL-7.93C	5/16	7.93	R 3/8	0.25	6.35	11/16	17.5	0.91	23.1	1.2	30.5	1.03	26.2	0.64	16.2
VUWL-9.52A	3/8	9.52	R 1/8	0.19	4.8	5/8	15.9	0.91	23.1	1.2	30.5	0.82	20.8	0.66	16.8
VUWL-9.52B	3/8	9.52	R 1/4	0.28	7.1	5/8	15.9	0.91	23.1	1.2	30.5	1	25.4	0.66	16.8
VUWL-9.52C	3/8	9.52	R 3/8	0.28	7.1	11/16	17.5	0.94	23.9	1.23	31.2	1.03	26.2	0.66	16.8
VUWL-9.52D	3/8	9.52	R 1/2	0.28	7.1	13/16	20.6	1.02	25.9	1.31	33.3	1.3	33	0.66	16.8
VUWL-9.52E	3/8	9.52	R 3/4	0.28	7.1	1 1/8	28.6	1.17	29.7	1.46	37.1	1.45	36.8	0.66	16.8
VUWL-12.7B	1/2	12.7	R 1/4	0.28	7.1	13/16	20.6	1.02	25.9	1.42	36.1	1.11	28.2	0.9	22.9
VUWL-12.7C	1/2	12.7	R 3/8	0.37	9.5	13/16	20.6	1.02	25.9	1.42	36.1	1.11	28.2	0.9	22.9
VUWL-12.7D	1/2	12.7	R 1/2	0.41	10.4	13/16	20.6	1.02	25.9	1.42	36.1	1.3	33	0.9	22.9
VUWL-12.7E	1/2	12.7	R 3/4	0.41	10.4	1 1/8	28.6	1.17	29.7	1.57	39.9	1.45	36.8	0.9	22.9
VUWL-15.88C	5/8	15.88	R 3/8	0.38	9.6	15/16	23.8	1.1	27.9	1.5	38.1	1.19	30.2	0.96	24.4
VUWL-15.88D	5/8	15.88	R 1/2	0.47	11.9	15/16	23.8	1.1	27.9	1.5	38.1	1.38	35.1	0.96	24.4
VUWL-15.88E	5/8	15.88	R 3/4	0.5	12.7	1 1/8	28.6	1.17	29.7	1.57	39.9	1.45	36.8	0.96	24.4
VUWL-19.05D	3/4	19.05	R 1/2	0.47	11.9	1 1/16	27	1.17	29.7	1.57	39.9	1.45	36.8	0.96	24.4
VUWL-19.05E	3/4	19.05	R 3/4	0.62	15.8	1 1/16	27	1.17	29.7	1.57	39.9	1.45	36.8	0.96	24.4
VUWL-22.22E	7/8	22.22	R 3/4	0.62	15.8	1 3/8	34.9	1.36	34.5	1.76	44.7	1.64	41.7	1.02	25.9
VUWL-25.4E	1	25.4	R 3/4	0.62	15.8	1 3/8	34.9	1.45	36.8	1.93	49	1.64	41.7	1.23	31.2
VUWL-25.4F	1	25.4	R 1	0.86	21.8	1 3/8	34.9	1.45	36.8	1.93	49	1.83	46.5	1.23	31.2

Reference Specifications:

DIN - 2999
 BS - 21
 JIS - B0203
 ISO - 1/7-BSP-T

Designation:

R marking on hex.

D - Dimension is minimum hole diameter - dimensions are for reference only, and are subject to change without notice.

Male Pipe Weld Elbows

LR

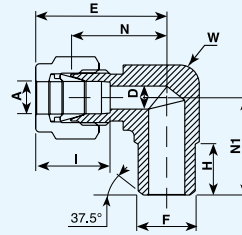

Tube (Inch) To Pipe (Inch)

Part Numbers	A Tube O.D.		F Tube size.		D		W		N		H		E		N ₁		I	
	in	mm	in	mm	in	mm	in	mm	in	mm	in	mm	in	mm	in	mm	in	mm
	VUWLR-6.35X10.3	1/4	6.35	1/8	10.3	0.19	4.8	1/2	12.7	0.77	19.6	0.38	9.7	1.06	26.9	0.74	18.8	0.6
VUWLR-6.35X13.7	1/4	6.35	1/4	13.7	0.19	4.8	1/2	12.7	0.77	19.6	0.56	14.2	1.06	26.9	0.92	23.4	0.6	15.2
VUWLR-9.52X13.7	3/8	9.52	1/4	13.7	0.28	7.1	5/8	15.9	0.91	23.1	0.56	14.2	1.2	30.5	1	25.4	0.66	16.8
VUWLR-12.7X21.3	1/2	12.7	1/2	21.3	0.41	10.4	13/16	20.6	1.02	25.9	0.75	19.1	1.42	36.1	1.3	33	0.9	22.9
VUWLR-19.05X26.7	3/4	19.05	3/4	26.7	0.62	15.8	1 1/8	28.6	1.17	29.7	0.75	19.1	1.57	39.9	1.45	36.8	0.96	24.4

Tube Socket Weld Elbows

LR

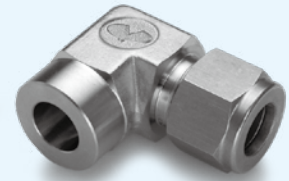
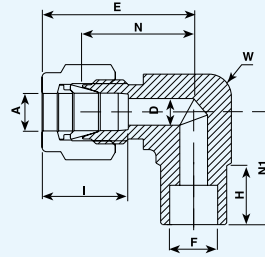

Tube (Inch) To Pipe (Inch)

Part Numbers	A Tube O.D.		F Tube size.		D		W		N		H		E		N ₁		I	
	in	mm	in	mm	in	mm	in	mm	in	mm	in	mm	in	mm	in	mm	in	mm
	VUWLR-6.35X6.35F	1/4	6.35	1/4	6.35	0.19	4.8	1/2	12.7	0.77	19.6	0.31	7.9	1.06	26.9	0.77	19.6	0.6
VUWLR-9.52X9.52F	3/8	9.52	3/8	9.52	0.28	7.1	5/8	15.9	0.91	23.1	0.38	9.7	1.2	30.5	0.91	23.1	0.66	16.8
VUWLR-12.7X12.7F	1/2	12.7	1/2	12.7	0.41	10.4	15/16	23.8	1.02	25.9	0.5	12.7	1.42	36.1	1.02	25.9	0.9	22.9

"D" - Dimension is minimum hole diameter - dimensions are for reference only, and are subject to change without notice.

Female Elbows

LG

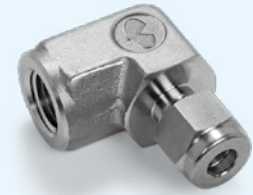
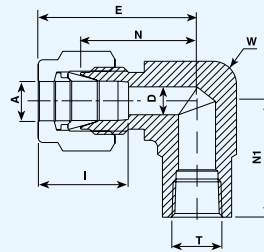

V-Lok Tube Fittings Female Elbows

Tube (Metric) To Female NPT Thread

Part Numbers	A Tube O.D.		T	D		W		N		E		N1		I	
	mm			mm	in	mm	mm	mm	mm	mm	mm	mm	mm	mm	
VUWLG-6AN	6		1/8NPT	4.8	5/8	15.9	19.6	27	21.6	15.3					
VUWLG-6BN	6		1/4NPT	4.8	11/16	17.5	22.4	29.8	22.4	15.3					
VUWLG-10BN	10		1/4NPT	7.9	13/16	20.6	25.9	33.5	22.4	17.2					
VUWLG-12BN	12		1/4NPT	9.5	13/16	20.6	25.9	36	22.4	22.8					
VUWLG-12DN	12		1/2NPT	9.5	1 1/8	28.6	28.7	38.5	28.4	22.8					

Tube (Inch) To Female NPT Thread

Part Numbers	A Tube O.D.		T	D		W		N		E		N1		I	
	in	mm		in	mm	in	mm	in	mm	in	mm	in	mm	in	mm
VUWLG-3.2AN	1/8	3.2	1/8NPT	0.09	2.3	5/8	15.9	0.71	18	0.97	24.6	0.75	19.1	0.5	12.7
VUWLG-3.2BN	1/8	3.2	1/4NPT	0.09	2.3	13/16	20.6	0.82	20.8	1.08	27.4	0.94	23.8	0.5	12.7
VUWLG-4.8AN	3/16	4.8	1/8NPT	0.12	3	5/8	15.9	0.74	18.8	1	25.4	0.75	19.1	0.54	13.7
VUWLG-6.35AN	1/4	6.35	1/8NPT	0.19	4.8	1/2	12.7	0.77	19.6	1.06	26.9	0.75	19.1	0.6	15.3
VUWLG-6.35BN	1/4	6.35	1/4NPT	0.19	4.8	11/16	17.5	0.88	22.4	1.17	29.7	0.88	22.4	0.6	15.3
VUWLG-6.35CN	1/4	6.35	3/8NPT	0.19	4.8	15/16	23.8	0.96	24.4	1.25	31.8	0.88	22.4	0.6	15.3
VUWLG-6.35DN	1/4	6.35	1/2NPT	0.19	4.8	1 1/8	28.6	1.07	27.2	1.36	34.5	1.12	28.5	0.6	15.3
VUWLG-7.93AN	5/16	7.93	1/8NPT	0.25	6.35	9/16	14.3	0.84	21.3	1.13	28.7	0.75	19.1	0.64	16.2
VUWLG-7.93BN	5/16	7.93	1/4NPT	0.25	6.35	13/16	20.6	0.91	23.1	1.2	30.5	0.88	22.4	0.64	16.2
VUWLG-9.52AN	3/8	9.52	1/8NPT	0.28	7.1	5/8	15.9	0.91	23.1	1.2	30.5	0.75	19.1	0.66	16.9
VUWLG-9.52BN	3/8	9.52	1/4NPT	0.28	7.1	11/16	20.6	0.94	23.9	1.23	31.2	0.88	22.4	0.66	16.9
VUWLG-9.52CN	3/8	9.52	3/8NPT	0.28	7.1	15/16	23.8	1.02	25.9	1.31	33.3	0.88	22.4	0.66	16.9
VUWLG-9.52DN	3/8	9.52	1/2NPT	0.28	7.1	1 1/16	27	1.12	28.7	1.42	36.1	1.12	28.5	0.66	16.9
VUWLG-12.7BN	1/2	12.7	1/4NPT	0.41	10.4	13/16	20.6	1.02	25.9	1.42	36.1	0.88	22.4	0.9	22.9
VUWLG-12.7CN	1/2	12.7	3/8NPT	0.41	10.4	15/16	23.8	1.02	25.9	1.42	36.1	0.88	22.4	0.9	22.9
VUWLG-12.7DN	1/2	12.7	1/2NPT	0.41	10.4	1 1/16	27	1.12	28.7	1.53	36.9	1.12	28	0.9	22.9
VUWLG-15.88CN	5/8	15.88	3/8NPT	0.5	12.7	15/16	23.8	1.1	27.9	1.5	38.1	0.88	22.4	0.96	24.4
VUWLG-15.88DN	5/8	15.88	1/2NPT	0.5	12.7	1 1/8	28.6	1.17	29.7	1.57	39.9	1.12	28.5	0.96	24.4
VUWLG-19.05DN	3/4	19.05	1/2NPT	0.62	15.7	1 1/8	28.6	1.17	29.7	1.57	39.9	1.12	28.5	0.96	24.4
VUWLG-19.05EN	3/4	19.05	3/4NPT	0.62	15.7	1 3/8	34.9	1.36	34.5	1.76	44.7	1.25	31.8	0.96	24.4
VUWLG-22.22EN	7/8	22.22	3/4NPT	0.72	18.3	1 3/8	34.9	1.25	31.8	1.76	44.7	1.25	31.8	1.02	25.9
VUWLG-25.4EN	1	25.4	3/4NPT	0.88	22.3	1 3/8	34.9	1.25	31.8	1.93	49	1.25	31.8	1.23	31.2
VUWLG-25.4FN	1	25.4	1NPT	0.88	22.3	1 11/16	42.9	1.63	41.4	2.11	53.6	1.5	38.1	1.23	31.2

"D" - Dimension is minimum hole diameter - dimensions are for reference only, and are subject to change without notice.

Female Elbows (Rc)

LG

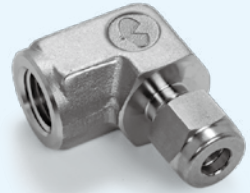
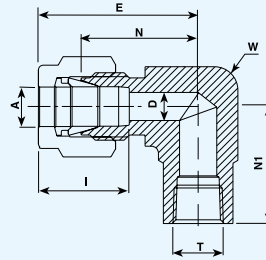

Tube (Metric) To ISO Tapered Thread

Part Numbers	A Tube O.D.		T	D		W		N		E		N1		I	
	in	mm		in	mm	in	mm	in	mm	in	mm	in	mm	in	mm
VUWLG-6A		6	Rc 1/8		4.8	5/8	15.9		19.6		27		21.6		15.3
VUWLG-6B		6	Rc 1/4		4.8	11/16	17.5		22.4		29.8		22.4		15.3
VUWLG-10B		10	Rc 1/4		7.9	13/16	20.6		25.9		33.5		22.4		17.2
VUWLG-12B		12	Rc 1/4		9.5	13/16	20.6		25.9		36		22.4		22.8
VUWLG-12D		12	Rc 1/2		9.5	1 1/8	28.6		28.7		38.5		28.4		22.8

Tube (Inch) To ISO Tapered Thread

Part Numbers	A Tube O.D.		T	D		W		N		E		N1		I	
	in	mm		in	mm	in	mm	in	mm	in	mm	in	mm	in	mm
VUWLG-3.2A	1/8	3.2	Rc 1/8	0.09	2.3	5/8	15.9	0.71	18	0.97	24.6	0.75	19.1	0.5	12.7
VUWLG-3.2B	1/8	3.2	Rc 1/4	0.09	2.3	13/16	20.6	0.82	20.8	1.08	27.4	0.94	23.8	0.5	12.7
VUWLG-4.8A	3/16	4.8	Rc 1/8	0.12	3	5/8	15.9	0.74	18.8	1	25.4	0.75	19.1	0.54	13.7
VUWLG-6.35A	1/4	6.35	Rc 1/8	0.19	4.8	1/2	12.7	0.77	19.6	1.06	26.9	0.75	19.1	0.6	15.3
VUWLG-6.35B	1/4	6.35	Rc 1/4	0.19	4.8	11/16	17.5	0.88	22.4	1.17	29.7	0.88	22.4	0.6	15.3
VUWLG-6.35C	1/4	6.35	Rc 3/8	0.19	4.8	15/16	23.8	0.96	24.4	1.25	31.8	0.88	22.4	0.6	15.3
VUWLG-6.35D	1/4	6.35	Rc 1/2	0.19	4.8	1 1/8	28.6	1.07	27.2	1.36	34.5	1.12	28.5	0.6	15.3
VUWLG-7.93A	5/16	7.93	Rc 1/8	0.25	6.35	9/16	14.3	0.84	21.3	1.13	28.7	0.75	19.1	0.64	16.2
VUWLG-7.93B	5/16	7.93	Rc 1/4	0.25	6.35	13/16	20.6	0.91	23.1	1.2	30.5	0.88	22.4	0.64	16.2
VUWLG-9.52A	3/8	9.52	Rc 1/8	0.28	7.1	5/8	15.9	0.91	23.1	1.2	30.5	0.75	19.1	0.66	16.9
VUWLG-9.52B	3/8	9.52	Rc 1/4	0.28	7.1	11/16	20.6	0.94	23.9	1.23	31.2	0.88	22.4	0.66	16.9
VUWLG-9.52C	3/8	9.52	Rc 3/8	0.28	7.1	15/16	23.8	1.02	25.9	1.31	33.3	0.88	22.4	0.66	16.9
VUWLG-9.52D	3/8	9.52	Rc 1/2	0.28	7.1	1 1/16	27	1.12	28.7	1.42	36.1	1.12	28.5	0.66	16.9
VUWLG-12.7B	1/2	12.7	Rc 1/4	0.41	10.4	13/16	20.6	1.02	25.9	1.42	36.1	0.88	22.4	0.9	22.9
VUWLG-12.7C	1/2	12.7	Rc 3/8	0.41	10.4	15/16	23.8	1.02	25.9	1.42	36.1	0.88	22.4	0.9	22.9
VUWLG-12.7D	1/2	12.7	Rc 1/2	0.41	10.4	1 1/16	27	1.12	28.7	1.53	36.9	1.12	28.5	0.9	22.9
VUWLG-15.88C	5/8	15.88	Rc 3/8	0.5	12.7	15/16	23.8	1.1	27.9	1.5	38.1	0.88	22.4	0.96	24.4
VUWLG-15.88D	5/8	15.88	Rc 1/2	0.5	12.7	1 1/8	28.6	1.17	29.7	1.57	39.9	1.12	28.5	0.96	24.4
VUWLG-19.05D	3/4	19.05	Rc 1/2	0.62	15.7	1 1/8	28.6	1.17	29.7	1.57	39.9	1.12	28.5	0.96	24.4
VUWLG-19.05E	3/4	19.05	Rc 3/4	0.62	15.8	1 3/8	34.9	1.36	34.5	1.76	44.7	1.25	31.8	0.96	24.4
VUWLG-22.22E	7/8	22.22	Rc 3/4	0.72	18.3	1 3/8	34.9	1.25	31.8	1.76	44.7	1.25	31.8	1.02	25.9
VUWLG-25.4E	1	25.4	Rc 3/4	0.88	22.3	1 3/8	34.9	1.25	31.8	1.93	49	1.25	31.8	1.23	31.2
VUWLG-25.4F	1	25.4	Rc 1	0.88	22.3	1 11/16	42.9	1.63	41.4	2.11	53.6	1.5	38.1	1.23	31.2

Designation:

R marking on hex.

"D" - Dimension is minimum hole diameter - dimensions are for reference only, and are subject to change without notice.

Male Run Tees (NPT)

TL

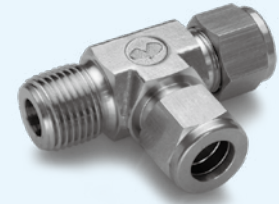
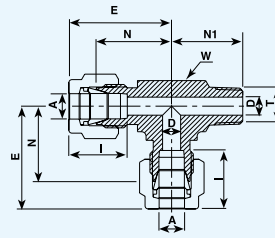

V-Lok Tube Fittings Male Run Tees (NPT)

Tube (Metric) To Male NPT Thread

Part Numbers	A Tube O.D.		T	D		W		N		E		N ₁		I	
	in	mm		in	mm	in	mm	in	mm	in	mm	in	mm	in	mm
VUWTL-6AN		6	1/8NPT		4.8	1/2	12.7		19.6		27		18.8		15.3
VUWTL-6BN		6	1/4NPT		4.8	1/2	12.7		19.6		27		23.4		15.3
VUWTL-8AN		8	1/8NPT		4.8	5/8	15.9		22.4		29.9		20.8		16.2
VUWTL-8BN		8	1/4NPT		6.4	5/8	15.9		22.4		29.9		25.4		16.2
VUWTL-10BN		10	1/4NPT		7.1	13/16	20.6		25.9		33.5		28.2		16.2
VUWTL-12BN		12	1/4NPT		7.1	13/16	20.6		25.9		36		28.2		22.8
VUWTL-12CN		12	3/8NPT		9.5	13/16	20.6		25.9		36		28.2		22.8
VUWTL-12DN		12	1/2NPT		9.5	15/16	23.8		25.9		36		33		22.8
VUWTL-16DN		16	1/2NPT		11.9	15/16	23.8		27.9		38		35		24.4

Tube (Inch) To Male NPT Thread

Part Numbers	A Tube O.D.		T	D		W		N		E		N ₁		I	
	in	mm		in	mm	in	mm	in	mm	in	mm	in	mm	in	mm
VUWTL-3.2AN	1/8	3.2	1/8NPT	0.09	2.3	7/16	11.1	0.67	17	0.93	23.6	0.7	17.8	0.5	12.7
VUWTL-3.2BN	1/8	3.2	1/4NPT	0.09	2.3	1/2	12.7	0.71	18	0.97	24.6	0.92	23.4	0.5	12.7
VUWTL-4.8AN	3/16	4.8	1/8NPT	0.12	3.1	7/16	11.1	0.7	17.8	0.96	24.4	0.7	17.8	0.54	13.7
VUWTL-6.35AN	1/4	6.35	1/8NPT	0.19	4.8	1/2	12.7	0.77	19.6	1.06	26.9	0.74	18.8	0.6	15.2
VUWTL-6.35BN	1/4	6.35	1/4NPT	0.19	4.8	1/2	12.7	0.77	19.6	1.06	26.9	0.92	23.4	0.6	15.2
VUWTL-7.93AN	5/16	7.93	1/8NPT	0.19	4.8	5/8	15.9	0.88	22.4	1.17	29.7	0.82	20.8	0.64	16.3
VUWTL-9.52BN	3/8	9.52	1/4NPT	0.28	7.1	5/8	15.9	0.91	23.1	1.2	30.5	1	25.4	0.66	16.8
VUWTL-9.52CN	3/8	9.52	3/8NPT	0.28	7.1	13/16	20.6	1.02	25.9	1.31	33.3	1.11	28.2	0.66	16.8
VUWTL-12.7CN	1/2	12.7	3/8NPT	0.38	9.5	13/16	20.6	1.02	25.9	1.42	36.1	1.11	28.2	0.9	22.9
VUWTL-12.7DN	1/2	12.7	1/2NPT	0.41	10.4	13/16	20.6	1.02	25.9	1.42	36.1	1.3	33	0.9	22.9
VUWTL-15.88DN	5/8	15.88	1/2NPT	0.47	11.9	15/16	23.8	1.1	27.9	1.5	38.1	1.38	35.1	0.96	24.4
VUWTL-19.05EN	3/4	19.05	3/4NPT	0.62	15.8	1 1/8	28.6	1.17	29.7	1.57	39.9	1.45	36.8	0.96	24.4

"D" - Dimension is minimum hole diameter - dimensions are for reference only, and are subject to change without notice.

Male Run Tees (R)

TL

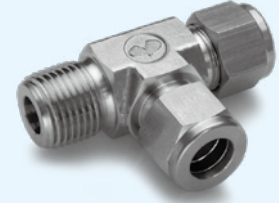
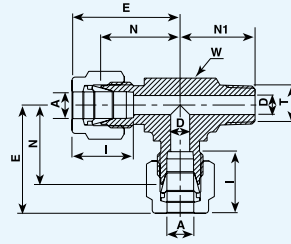

Tube (Metric) To ISO Tapered Thread

Part Numbers	A Tube O.D.		T	D		W		N		E		N ₁		I	
	in	mm		in	mm	in	mm	in	mm	in	mm	in	mm	in	mm
VUWTL-6A	1/8	3.2	R 1/8	0.09	2.3	7/16	11.1	0.67	17	0.93	23.6	0.7	17.8	0.5	12.7
VUWTL-6B	1/8	3.2	R 1/4	0.09	2.3	1/2	12.7	0.71	18	0.97	24.6	0.92	23.4	0.5	12.7
VUWTL-8A	3/16	4.8	R 1/8	0.12	3.1	7/16	11.1	0.7	17.8	0.96	24.4	0.7	17.8	0.54	13.7
VUWTL-8B	3/16	4.8	R 1/4	0.12	3.1	1/2	12.7	0.77	19.6	1.06	26.9	0.74	18.8	0.6	15.2
VUWTL-10B	1/4	6.35	R 1/8	0.19	4.8	1/2	12.7	0.77	19.6	1.06	26.9	0.92	23.4	0.6	15.2
VUWTL-10C	1/4	6.35	R 1/4	0.19	4.8	1/2	12.7	0.77	19.6	1.06	26.9	0.92	23.4	0.6	15.2
VUWTL-12B	5/16	7.93	R 1/8	0.19	4.8	5/8	15.9	0.88	22.4	1.17	29.7	0.82	20.8	0.64	16.3
VUWTL-12C	5/16	7.93	R 1/4	0.28	7.1	5/8	15.9	0.91	23.1	1.2	30.5	1	25.4	0.66	16.8
VUWTL-12D	3/8	9.52	R 3/8	0.28	7.1	13/16	20.6	1.02	25.9	1.31	33.3	1.11	28.2	0.66	16.8
VUWTL-12E	3/8	9.52	R 1/2	0.41	10.4	13/16	20.6	1.02	25.9	1.42	36.1	1.11	28.2	0.9	22.9
VUWTL-15.88D	1/2	12.7	R 1/2	0.41	10.4	13/16	20.6	1.02	25.9	1.42	36.1	1.3	33	0.9	22.9
VUWTL-16D	1/2	12.7	R 3/4	0.47	11.9	15/16	23.8	1.1	27.9	1.5	38.1	1.38	35.1	0.96	24.4
VUWTL-19.05E	3/4	19.05	R 1/2	0.62	15.8	15/16	23.8	1.17	29.7	1.57	39.9	1.45	36.8	0.96	24.4

Tube (Inch) To ISO Tapered Thread

Part Numbers	A Tube O.D.		T	D		W		N		E		N ₁		I	
	in	mm		in	mm	in	mm	in	mm	in	mm	in	mm	in	mm
VUWTL-3.2A	1/8	3.2	R 1/8	0.09	2.3	7/16	11.1	0.67	17	0.93	23.6	0.7	17.8	0.5	12.7
VUWTL-3.2B	1/8	3.2	R 1/4	0.09	2.3	1/2	12.7	0.71	18	0.97	24.6	0.92	23.4	0.5	12.7
VUWTL-4.8A	3/16	4.8	R 1/8	0.12	3.1	7/16	11.1	0.7	17.8	0.96	24.4	0.7	17.8	0.54	13.7
VUWTL-6.35A	1/4	6.35	R 1/8	0.19	4.8	1/2	12.7	0.77	19.6	1.06	26.9	0.74	18.8	0.6	15.2
VUWTL-6.35B	1/4	6.35	R 1/4	0.19	4.8	1/2	12.7	0.77	19.6	1.06	26.9	0.92	23.4	0.6	15.2
VUWTL-7.93A	5/16	7.93	R 1/8	0.19	4.8	5/8	15.9	0.88	22.4	1.17	29.7	0.82	20.8	0.64	16.3
VUWTL-9.52B	3/8	9.52	R 1/4	0.28	7.1	5/8	15.9	0.91	23.1	1.2	30.5	1	25.4	0.66	16.8
VUWTL-9.52C	3/8	9.52	R 3/8	0.28	7.1	13/16	20.6	1.02	25.9	1.31	33.3	1.11	28.2	0.66	16.8
VUWTL-12.7C	1/2	12.7	R 3/8	0.38	9.5	13/16	20.6	1.02	25.9	1.42	36.1	1.11	28.2	0.9	22.9
VUWTL-12.7D	1/2	12.7	R 1/2	0.41	10.4	13/16	20.6	1.02	25.9	1.42	36.1	1.3	33	0.9	22.9
VUWTL-15.88D	5/8	15.88	R 1/2	0.47	11.9	15/16	23.8	1.1	27.9	1.5	38.1	1.38	35.1	0.96	24.4
VUWTL-19.05E	3/4	19.05	R 3/4	0.62	15.8	1 1/8	28.6	1.17	29.7	1.57	39.9	1.45	36.8	0.96	24.4

Designation:

R marking on hex.

"D" - Dimension is minimum hole diameter - dimensions are for reference only, and are subject to change without notice.

Female Run Tees (NPT)

TLG

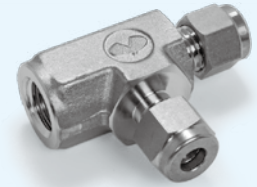
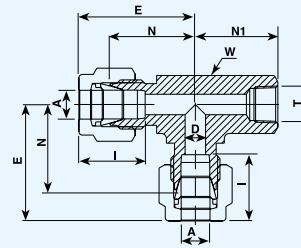

Tube (Metric) To Female NPT Thread

Part Numbers	A Tube O.D.		T	D		W		N		E		N ₁		I	
	in	mm		in	mm	in	mm	in	mm	in	mm	in	mm	in	mm
VUWTLG-6AN		6	1/8NPT	0.19	4.8	5/8	15.9	0.77	19.6	1.06	27	0.74	19	0.6	15.3
VUWTLG-6BN		6	1/4NPT	0.19	4.8	13/16	20.6	0.88	22.4	1.17	29.8	0.88	22.4	0.6	15.3
VUWTLG-12BN		12	1/4NPT	0.37	9.5	13/16	20.6	1.01	25.9	1.41	36	0.88	22.4	0.89	22.8
VUWTLG-12DN		12	1/2NPT	0.37	9.5	1 1/8	28.6	1.16	29.7	1.57	39.8	1.12	28.5	0.89	22.8

Tube (Metric) To Female NPT Thread

Part Numbers	A Tube O.D.		T	D		W		N		E		N ₁		I	
	in	mm		in	mm	in	mm	in	mm	in	mm	in	mm	in	mm
VUWTLG-3.2AN	1/8	3.2	1/8NPT	0.09	2.3	5/8	15.9	0.71	18	0.97	24.4	0.75	19.1	0.5	12.7
VUWTLG-6.35AN	1/4	6.35	1/8NPT	0.19	4.8	5/8	15.9	0.77	19.6	1.06	26.9	0.75	19.1	0.6	15.2
VUWTLG-6.35BN	1/4	6.35	1/4NPT	0.19	4.8	13/16	20.6	0.88	22.4	1.17	29.7	0.88	22.4	0.6	15.2
VUWTLG-9.52BN	3/8	9.52	1/4NPT	0.28	7.1	13/16	20.6	0.94	23.9	1.23	31.2	0.88	22.4	0.66	16.8
VUWTLG-12.7CN	1/2	12.7	3/8NPT	0.41	10.4	15/16	23.8	1.02	25.9	1.42	36.1	0.88	22.4	0.9	22.9
VUWTLG-12.7DN	1/2	12.7	1/2NPT	0.41	10.4	1 1/16	27	1.17	29.7	1.57	39.9	1.12	28.5	0.9	22.9
VUWTLG-19.05EN	3/4	19.05	3/4NPT	0.62	15.8	1 3/8	34.9	1.36	34.5	1.76	44.7	1.25	31.8	0.9	24.4

"D" - Dimension is minimum hole diameter - dimensions are for reference only, and are subject to change without notice.

Female Run Tees (Rc)

TLG

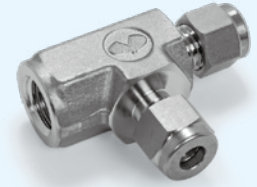
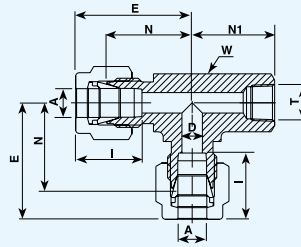

Tube (Metric) To ISO Tapered Thread

Part Numbers	A Tube O.D.		T	D		W		N		E		N ₁		I	
	in	mm		in	mm	in	mm	in	mm	in	mm	in	mm	in	mm
VUWTLG-6A	1/8	3.2	Rc 1/8	0.09	2.3	5/8	15.9	0.77	19.6	1.06	27	0.74	19	0.6	15.3
VUWTLG-6B	1/4	6.35	Rc 1/4	0.19	4.8	13/16	20.6	0.88	22.4	1.17	29.8	0.88	22.4	0.6	15.3
VUWTLG-12B	1/2	12.7	Rc 1/4	0.37	9.5	13/16	20.6	1.01	25.9	1.41	36	0.88	22.4	0.89	22.8
VUWTLG-12D	1/2	12.7	Rc 1/2	0.37	9.5	1 1/8	28.6	1.16	29.7	1.57	39.8	1.12	28.5	0.89	22.8

Tube (Inch) To ISO Tapered Thread

Part Numbers	A Tube O.D.		T	D		W		N		E		N ₁		I	
	in	mm		in	mm	in	mm	in	mm	in	mm	in	mm	in	mm
VUWTLG-3.2A	1/8	3.2	Rc 1/8	0.09	2.3	5/8	15.9	0.71	18	0.97	24.4	0.75	19.1	0.5	12.7
VUWTLG-6.35A	1/4	6.35	Rc 1/8	0.19	4.8	5/8	15.9	0.77	19.6	1.06	26.9	0.75	19.1	0.6	15.2
VUWTLG-6.35B	1/4	6.35	Rc 1/4	0.19	4.8	13/16	20.6	0.88	22.4	1.17	29.7	0.88	22.4	0.6	15.2
VUWTLG-9.52B	3/8	9.52	Rc 1/4	0.28	7.1	13/16	20.6	0.94	23.9	1.23	31.2	0.88	22.4	0.66	16.8
VUWTLG-12.7C	1/2	12.7	Rc 3/8	0.41	10.4	15/16	23.8	1.02	25.9	1.42	36.1	0.88	22.4	0.9	22.9
VUWTLG-12.7D	1/2	12.7	Rc 1/2	0.41	10.4	1 1/16	27	1.17	29.7	1.57	39.9	1.12	28.5	0.9	22.9
VUWTLG-19.05E	3/4	19.05	Rc 3/4	0.62	15.8	1 3/8	34.9	1.36	34.5	1.76	44.7	1.25	31.8	0.9	24.4

Designation:

R marking on hex.

"D" - Dimension is minimum hole diameter - dimensions are for reference only, and are subject to change without notice.

Male Branch Tees (NPT)

TS

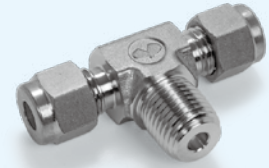
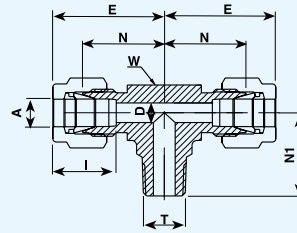

Tube (Metric) To Male NPT Thread

Part Numbers	A Tube O.D.		T	D		W		N		E		N ₁		I	
	in	mm		in	mm	in	mm	in	mm	in	mm	in	mm	in	mm
VUWTS-6AN		6	1/8NPT		4.8	1/2	12.7		19.6		27		18.8		15.3
VUWTS-6BN		6	1/4NPT		4.8	1/2	12.7		19.6		27		23.4		15.3
VUWTS-8AN		8	1/8NPT		4.8	5/8	15.9		22.4		29.9		20.8		16.2
VUWTS-8BN		8	1/4NPT		6.4	5/8	15.9		22.4		29.9		25.4		16.2
VUWTS-10BN		10	1/4NPT		7.1	13/16	20.6		25.9		33.5		28.2		17.2
VUWTS-12BN		12	1/4NPT		7.1	13/16	20.6		25.9		36		28.2		22.8
VUWTS-12CN		12	3/8NPT		9.5	13/16	20.6		25.9		36		28.2		22.8
VUWTS-12DN		12	1/2NPT		9.5	13/16	20.6		25.9		36		33		22.8
VUWTS-16DN		16	1/2NPT		11.9	15/16	23.8		28.7		38.8		35.8		24.4

Tube (Inch) To Male NPT Thread

Part Numbers	A Tube O.D.		T	D		W		N		E		N ₁		I	
	in	mm		in	mm	in	mm	in	mm	in	mm	in	mm	in	mm
	VUWTS-3.2AN	1/8		3.2	1/8NPT	0.09	2.3	7/16	11.1	0.67	17	0.93	23.6	0.7	17.8
VUWTS-3.2BN	1/8	3.2	1/4NPT	0.09	2.3	1/2	12.7	0.71	18	0.97	24.6	0.92	23.3	0.5	12.7
VUWTS-4.8AN	3/16	4.8	1/8NPT	0.12	3	7/16	11.1	0.7	17.8	0.96	24.4	0.7	17.8	0.54	13.7
VUWTS-6.35AN	1/4	6.35	1/8NPT	0.19	4.8	1/2	12.7	0.77	19.6	1.06	26.9	0.74	18.8	0.6	15.2
VUWTS-6.35BN	1/4	6.35	1/4NPT	0.19	4.8	1/2	12.7	0.77	19.6	1.06	26.9	0.92	23.4	0.6	15.2
VUWTS-7.93AN	5/16	7.93	1/8NPT	0.19	4.8	5/8	15.9	0.88	22.4	1.17	29.7	0.82	20.8	0.64	16.2
VUWTS-9.52BN	3/8	9.52	1/4NPT	0.28	7.1	5/8	15.9	0.91	23.1	1.2	30.5	1	25.4	0.66	16.8
VUWTS-9.52CN	3/8	9.52	3/8NPT	0.28	7.1	13/16	20.6	1.02	25.9	1.31	33.3	1.11	28.2	0.66	16.8
VUWTS-12.7CN	1/2	12.7	3/8NPT	0.38	9.5	13/16	20.6	1.02	25.9	1.42	36.1	1.11	28.2	0.9	22.9
VUWTS-12.7DN	1/2	12.7	1/2NPT	0.41	10.4	13/16	20.6	1.02	26	1.42	36.1	1.3	33	0.9	22.9
VUWTS-15.88DN	5/8	15.88	1/2NPT	0.47	11.9	15/16	23.8	1.13	28.7	1.53	38.9	1.41	35.8	0.96	24.4
VUWTS-19.05EN	3/4	19.05	3/4NPT	0.62	15.8	1 1/16	27	1.17	29.7	1.57	39.9	1.45	36.8	0.96	24.4

"D" - Dimension is minimum hole diameter - dimensions are for reference only, and are subject to change without notice.

Male Branch Tees (R)

TS

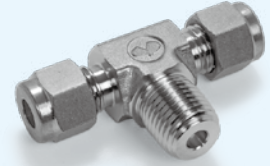
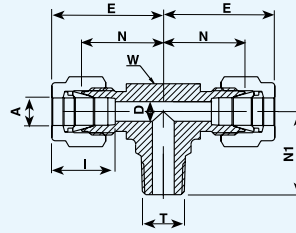

Tube (Metric) To ISO Tapered Thread

Part Numbers	A Tube O.D.		T	D		W		N		E		N ₁		I
	mm			mm	in	mm	mm	mm	mm	mm	mm	mm	mm	
VUWTS-6A	6		R 1/8	4.8	1/2	12.7		19.6		27		18.8		15.3
VUWTS-6B	6		R 1/4	4.8	1/2	12.7		19.6		27		23.4		15.3
VUWTS-8A	8		R 1/8	4.8	5/8	15.9		22.4		29.9		20.8		16.2
VUWTS-8B	8		R 1/4	6.4	5/8	15.9		22.4		29.9		25.4		16.2
VUWTS-10B	10		R 1/4	7.1	13/16	20.6		25.9		33.5		28.2		17.2
VUWTS-12B	12		R 1/4	7.1	13/16	20.6		25.9		36		28.2		22.8
VUWTS-12C	12		R 3/8	9.5	13/16	20.6		25.9		36		28.2		22.8
VUWTS-12D	12		R 1/2	9.5	13/16	20.6		25.9		36		33		22.8
VUWTS-16D	16		R 1/2	11.9	15/16	23.8		28.7		38.8		35.8		24.4

Tube (Inch) To ISO Tapered Thread

Part Numbers	A Tube O.D.		T	D		W		N		E		N ₁		I	
	in	mm		in	mm	in	mm	in	mm	in	mm	in	mm	in	mm
	VUWTS-3.2A	1/8		3.2	R 1/8	0.09	2.3	7/16	11.1	0.67	17	0.93	23.6	0.7	17.8
VUWTS-3.2B	1/8	3.2	R 1/4	0.09	2.3	1/2	12.7	0.71	18	0.97	24.6	0.92	23.4	0.5	12.7
VUWTS-4.8A	3/16	4.8	R 1/8	0.12	3	7/16	11.1	0.7	17.8	0.96	24.4	0.7	17.8	0.54	13.7
VUWTS-6.35A	1/4	6.35	R 1/8	0.19	4.8	1/2	12.7	0.77	19.6	1.06	26.9	0.74	18.8	0.6	15.2
VUWTS-6.35B	1/4	6.35	R 1/4	0.19	4.8	1/2	12.7	0.77	19.6	1.06	26.9	0.92	23.4	0.6	15.2
VUWTS-7.93A	5/16	7.93	R 1/8	0.19	4.8	5/8	15.9	0.88	22.4	1.17	29.7	0.82	20.8	0.64	16.2
VUWTS-9.52B	3/8	9.52	R 1/4	0.28	7.1	5/8	15.9	0.91	23.1	1.2	30.5	1	25.4	0.66	16.8
VUWTS-9.52C	3/8	9.52	R 3/8	0.28	7.1	13/16	20.6	1.02	25.9	1.31	33.3	1.11	28.2	0.66	16.8
VUWTS-12.7C	1/2	12.7	R 3/8	0.38	9.5	13/16	20.6	1.02	25.9	1.42	36.1	1.11	28.2	0.9	22.9
VUWTS-12.7D	1/2	12.7	R 1/2	0.41	10.4	13/16	20.6	1.02	26	1.42	36.1	1.3	33	0.9	22.9
VUWTS-15.88D	5/8	15.88	R 1/2	0.47	11.9	15/16	23.8	1.13	28.7	1.53	38.9	1.41	35.8	0.96	24.4
VUWTS-19.05E	3/4	19.05	R 3/4	0.62	15.8	1 1/16	27	1.17	29.7	1.57	39.9	1.45	36.8	0.96	24.4

Designation:

R marking on hex.

"D" - Dimension is minimum hole diameter - dimensions are for reference only, and are subject to change without notice.

Female Branch Tees (NPT)

TG

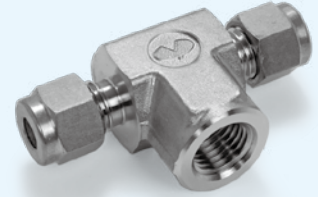
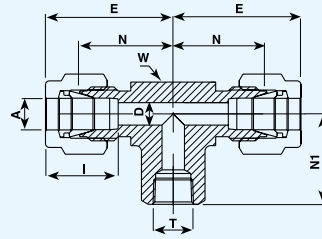

Tube (Metric) To Female NPT Thread

Part Numbers	A Tube O.D.		T	D		W		N		E		N ₁		I	
	in	mm		in	mm	in	mm	in	mm	in	mm	in	mm	in	mm
VUWTG-6AN		6	1/8NPT		4.8	5/8	15.9		19.6		27		19		15.3
VUWTG-6BN		6	1/4NPT		4.8	13/16	20.6		22.4		29.8		22.4		15.3
VUWTG-10BN		10	1/4NPT		7.9	13/16	20.6		25.9		33.5		22.4		17.2
VUWTG-10CN		10	3/8NPT		7.9	15/16	23.8		25.9		33.5		22.4		17.2
VUWTG-12BN		12	1/4NPT		9.5	13/16	20.6		25.9		36		22.4		22.8
VUWTG-12DN		12	1/2NPT		9.5	1 1/16	27		28.7		38.8		28.4		22.8
VUWTG-16DN		16	1/2NPT		12.7	1 1/8	28.6		28.7		38.8		28.4		24.4

Tube (Inch) To Female NPT Thread

Part Numbers	A Tube O.D.		T	D		W		N		E		N ₁		I	
	in	mm		in	mm	in	mm	in	mm	in	mm	in	mm	in	mm
VUWTG-3.2AN	1/8	3.2	1/8NPT	0.09	2.3	5/8	15.9	0.7	18	0.97	24.6	0.75	19.1	0.5	12.7
VUWTG-6.35AN	1/4	6.35	1/8NPT	0.19	4.8	5/8	15.9	0.77	19.6	1.06	26.9	0.75	19.1	0.6	15.2
VUWTG-6.35BN	1/4	6.35	1/4NPT	0.19	4.8	13/16	20.6	0.88	22.4	1.17	29.7	0.88	22.4	0.6	15.2
VUWTG-9.52BN	3/8	9.52	1/4NPT	0.28	7.1	13/16	20.6	0.94	23.9	1.23	31.2	0.88	22.4	0.66	16.8
VUWTG-12.7BN	1/2	12.7	1/4NPT	0.41	10.4	13/16	20.6	1.02	25.9	1.42	36.1	0.88	22.4	0.9	22.9
VUWTG-12.7CN	1/2	12.7	3/8NPT	0.41	10.4	15/16	23.8	1.02	25.9	1.42	36.1	0.88	22.4	0.9	22.9
VUWTG-12.7DN	1/2	12.7	1/2NPT	0.41	10.4	1 1/16	27	1.13	28.7	1.53	38.9	1.12	28.5	0.9	22.9
VUWTG-15.88DN	5/8	15.88	1/2NPT	0.5	12.7	1 1/16	27	1.13	28.7	1.53	38.9	1.12	28.4	0.96	24.4
VUWTG-19.05EN	3/4	19.05	3/4NPT	0.62	15.8	1 3/8	34.9	1.36	34.5	1.76	44.7	1.25	31.8	0.96	24.4
VUWTG-25.4EN	1	25.4	3/4NPT	0.88	22.3	1 3/8	34.9	1.45	36.8	1.93	49	1.25	31.8	1.23	31.2
VUWTG-25.4FN	1	25.4	1NPT	0.88	22.3	1 11/16	42.9	1.63	41.4	2.11	53.6	1.5	38.1	1.23	31.2

"D" - Dimension is minimum hole diameter - dimensions are for reference only, and are subject to change without notice.

Female Branch Tees (Rc)

TG

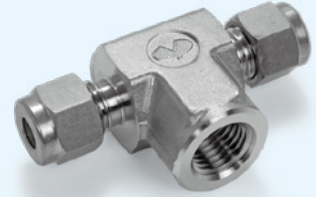
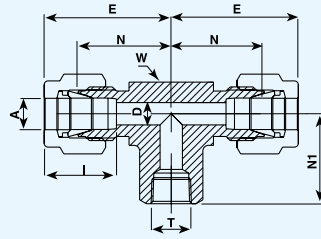

Tube (Metric) To ISO Tapered Thread

Part Numbers	A Tube O.D.		T	D		W		N		E		N ₁		I	
	in	mm		in	mm	in	mm	in	mm	in	mm	in	mm	in	mm
VUWTG-6A		6	Rc 1/8		4.8	5/8	15.9		19.6		27		19		15.3
VUWTG-6B		6	Rc 1/4		4.8	13/16	20.6		22.4		29.8		22.4		15.3
VUWTG-10B		10	Rc 1/4		7.9	13/16	20.6		25.9		33.5		22.4		17.2
VUWTG-10C		10	Rc 3/8		7.9	15/16	23.8		25.9		33.5		22.4		17.2
VUWTG-12B		12	Rc 1/4		9.5	13/16	20.6		25.9		36		22.4		22.8
VUWTG-12D		12	Rc 1/2		9.5	1 1/16	27		28.7		38.8		28.4		22.8
VUWTG-16D		16	Rc 1/2		12.7	1 1/8	28.6		28.7		38.8		28.4		24.4

Tube (Inch) To ISO Tapered Thread

Part Numbers	A Tube O.D.		T	D		W		N		E		N ₁		I	
	in	mm		in	mm	in	mm	in	mm	in	mm	in	mm	in	mm
VUWTG-3.2A	1/8	3.2	Rc 1/8	0.09	2.3	5/8	15.9	0.7	18	0.97	24.6	0.75	19.1	0.5	12.7
VUWTG-6.35A	1/4	6.35	Rc 1/8	0.19	4.8	5/8	15.9	0.77	19.6	1.06	26.9	0.75	19.1	0.6	15.2
VUWTG-6.35B	1/4	6.35	Rc 1/4	0.19	4.8	13/16	20.6	0.88	22.4	1.17	29.7	0.88	22.4	0.6	15.2
VUWTG-9.52B	3/8	9.52	Rc 1/4	0.28	7.1	13/16	20.6	0.94	23.9	1.23	31.2	0.88	22.4	0.66	16.8
VUWTG-12.7B	1/2	12.7	Rc 1/4	0.41	10.4	13/16	20.6	1.02	25.9	1.42	36.1	0.88	22.4	0.9	22.9
VUWTG-12.7C	1/2	12.7	Rc 3/8	0.41	10.4	15/16	23.8	1.02	25.9	1.42	36.1	0.88	22.4	0.9	22.9
VUWTG-12.7D	1/2	12.7	Rc 1/2	0.41	10.4	1 1/16	27	1.13	28.7	1.53	38.9	1.12	28.5	0.9	22.9
VUWTG-15.88D	5/8	15.88	Rc 1/2	0.5	12.7	1 1/16	27	1.13	28.7	1.53	38.9	1.12	28.4	0.96	24.4
VUWTG-19.05E	3/4	19.05	Rc 3/4	0.62	15.8	1 3/8	34.9	1.36	34.5	1.76	44.7	1.25	31.8	0.96	24.4
VUWTG-25.4E	1	25.4	Rc 3/4	0.88	22.3	1 3/8	34.9	1.45	36.8	1.93	49	1.25	31.8	1.23	31.2
VUWTG-25.4F	1	25.4	Rc 1	0.88	22.3	1 11/16	42.9	1.63	41.4	2.11	53.6	1.5	38.1	1.23	31.2

Designation:

R marking on hex.

"D" - Dimension is minimum hole diameter - dimensions are for reference only, and are subject to change without notice.

Bulkhead Unions

P

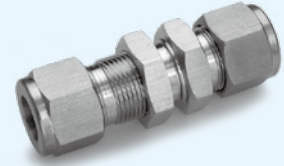
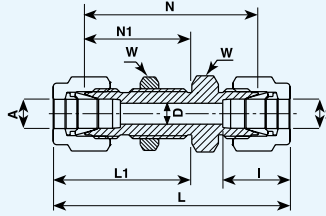

Tube (Metric) To Tube (Metric)

Part Numbers	A Tube O.D.		D		W		N		N ₁		L		L ₁		I		Panel hole drill size		Max. Panel thickness	
	mm	mm	mm	mm	mm	mm	mm	mm	mm	mm	mm	mm	mm	mm	mm	mm	mm	mm	mm	mm
VUWP-3	3		2.4		14		38.1		24.6		51.3		31.2		12.9		8.3		12.7	
VUWP-4	4		2.4		14		40.4		25.4		53.6		32		13.7		9.9		12.7	
VUWP-6	6		4.8		16		42.9		26.2		57.7		33.6		15.3		11.5		10.2	
VUWP-8	8		6.4		18		46		28.6		61		36.1		16.2		13.1		11.2	
VUWP-10	10		7.9		22		48.5		29.4		63.7		37		17.2		16.25		11.2	
VUWP-12	12		9.5		24		50.8		31.8		71		41.9		22.8		19.5		12.7	
VUWP-15	15		11.9		27		52.3		32.5		72.5		42.6		24.4		22.8		12.7	
VUWP-16	16		12.7		27		52.3		32.5		72.5		42.6		24.4		22.8		12.7	
VUWP-18	18		15.1		30		58.7		37.3		78.9		47.4		24.4		26		16.8	
VUWP-20	20		15.9		35		64.3		42.9		84.5		53		26		29		23.9	
VUWP-25	25		21.8		41		71.4		45.2		86.6		52.8		26.6		33.7		19	

Tube (Inch) To Tube (Inch)

Part Numbers	A Tube O.D.		D		W		N		N ₁		L		L ₁		I		Panel hole drill size		Max. Panel thickness	
	in	mm	in	mm	in	mm	in	mm	in	mm	in	mm	in	mm	in	mm	in	mm	in	mm
VUWP-1.6	1/16	1.6	0.05	1.3	5/16	7.9	0.94	23.9	0.53	13.5	1.24	31.5	0.68	17.3	0.34	8.6	13/64	5.2	0.12	3.1
VUWP-3.2	1/8	3.2	0.09	2.3	1/2	12.7	1.5	38.1	0.97	24.6	2.02	51.3	1.23	31.2	0.5	12.7	21/64	8.3	0.5	12.7
VUWP-4.8	3/16	4.8	0.12	3	9/16	14.3	1.59	40.4	1	25.4	2.11	53.6	1.26	32	0.54	13.7	25/64	9.9	0.5	12.7
VUWP-6.35	1/4	6.35	0.19	4.8	5/8	15.9	1.69	42.9	1.03	26.2	2.27	57.7	1.32	33.5	0.6	15.2	29/64	11.5	0.4	10.2
VUWP-7.93	5/16	7.93	0.25	6.4	11/16	17.5	1.81	46	1.12	28.4	2.39	60.7	1.41	35.8	0.64	16.2	33/64	13.1	0.44	11.2
VUWP-9.52	3/8	9.52	0.28	7.1	3/4	19.1	1.87	47.5	1.16	29.5	2.45	62.2	1.45	36.8	0.66	16.8	37/64	14.7	0.44	11.2
VUWP-12.7	1/2	12.7	0.41	10.4	15/16	23.8	2	50.8	1.25	31.8	2.8	71.1	1.65	41.9	0.9	22.9	49/64	19.4	0.5	12.7
VUWP-15.88	5/8	15.88	0.5	12.7	1 1/16	27	2.06	52.3	1.28	32.5	2.86	72.6	1.68	42.7	0.96	24.4	57/64	22.6	0.5	12.7
VUWP-19.05	3/4	19.05	0.62	15.9	1 3/16	30.2	2.31	58.7	1.47	37.3	3.11	79	1.87	47.5	0.96	24.4	1 1/64	25.8	0.66	16.8
VUWP-25.4	1	25.4	0.88	22.3	1 5/8	41.3	2.81	71.4	1.78	45.2	3.77	95.8	2.26	57.4	1.23	31.2	1 21/64	33.7	0.75	19.1

"D" - Dimension is minimum hole diameter - dimensions are for reference only, and are subject to change without notice.

Bulkhead Female Connectors (NPT)

GP

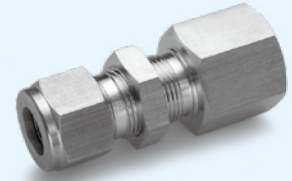
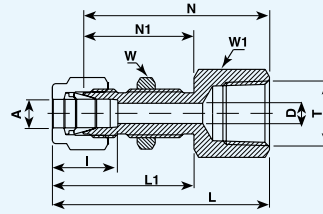

Tube (Inch) To Male NPT Thread

Part Numbers	A Tube O.D.		T	D		W		W ₁		N		N ₁		L		L ₁		I		Panel hole drill size		Max. Panel thickness	
	in	mm		in	mm	in	mm	in	mm	in	mm	in	mm	in	mm	in	mm	in	mm	in	mm	in	mm
VUWGP-3.2AN	1/8	3.2	1/8NPT	0.09	2.3	9/16	14.3	1/2	12.7	1.5	38.1	0.97	24.6	1.76	44.7	1.23	31.2	0.5	12.7	21/64	8.3	0.5	12.7
VUWGP-6.35AN	1/4	6.35	1/8NPT	0.19	4.8	5/8	15.9	5/8	15.9	1.56	39.6	1.03	26.2	1.85	47	1.32	33.5	0.6	15.2	29/64	11.5	0.4	10.2
VUWGP-6.35BN	1/4	6.35	1/4NPT	0.19	4.8	3/4	19.1	5/8	15.9	1.75	44.5	1.03	26.2	2.04	51.8	1.32	33.5	0.6	15.2	29/64	11.5	0.4	10.2
VUWGP-9.52BN	3/8	9.52	1/4NPT	0.28	7.1	3/4	19.1	3/4	19.1	1.88	47.8	1.16	29.5	2.17	55.1	1.45	36.8	0.66	16.8	37/64	14.7	0.44	11.2
VUWGP-12.7CN	1/2	12.7	3/8NPT	0.41	10.4	15/16	23.8	15/16	23.8	2.03	51.6	1.25	31.8	2.43	61.7	1.65	41.9	0.9	22.9	49/64	19.4	0.5	12.7
VUWGP-12.7DN	1/2	12.7	1/2NPT	0.41	10.4	1 1/16	27	15/16	23.8	2.22	56.4	1.25	31.8	2.62	66.6	1.65	41.9	0.9	22.9	49/64	19.4	0.5	12.7

Bulkhead Female Connectors (Rc)

GP

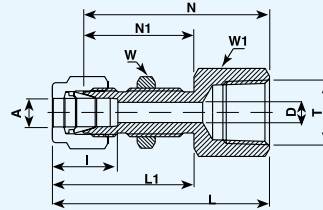

Tube (Inch) To ISO Tapered Thread (Rc)

Part Numbers	A Tube O.D.		T	D		W		W ₁		N		N ₁		L		L ₁		I		Panel hole drill size		Max. Panel thickness	
	in	mm		in	mm	in	mm	in	mm	in	mm	in	mm	in	mm	in	mm	in	mm	in	mm	in	mm
VUWGP-3.2A	1/8	3.2	Rc 1/8	0.09	2.3	9/16	14.3	1/2	12.7	1.5	38.1	0.97	24.6	1.76	44.7	1.23	31.2	0.5	12.7	21/64	8.3	0.5	12.7
VUWGP-6.35A	1/4	6.35	Rc 1/8	0.19	4.8	5/8	15.9	5/8	15.9	1.56	39.6	1.03	26.2	1.85	47	1.32	33.5	0.6	15.2	29/64	11.5	0.4	10.2
VUWGP-6.35B	1/4	6.35	Rc 1/4	0.19	4.8	3/4	19.1	5/8	15.9	1.75	44.5	1.03	26.2	2.04	51.8	1.32	33.5	0.6	15.2	29/64	11.5	0.4	10.2
VUWGP-9.52B	3/8	9.52	Rc 1/4	0.28	7.1	3/4	19.1	3/4	19.1	1.88	47.8	1.16	29.5	2.17	55.1	1.45	36.8	0.66	16.8	37/64	14.7	0.44	11.2
VUWGP-12.7C	1/2	12.7	Rc 3/8	0.41	10.4	15/16	23.8	15/16	23.8	2.03	51.6	1.25	31.8	2.43	61.7	1.65	41.9	0.9	22.9	49/64	19.4	0.5	12.7
VUWGP-12.7D	1/2	12.7	Rc 1/2	0.41	10.4	1 1/16	27	15/16	23.8	2.22	56.4	1.25	31.8	2.62	66.6	1.65	41.9	0.9	22.9	49/64	19.4	0.5	12.7

Designation:

R marking on hex.

Bulkhead Reducers

RP

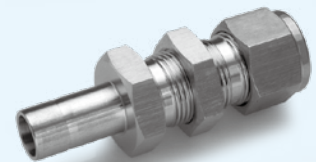
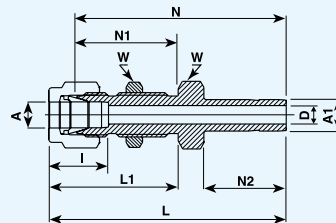

Tube (Inch) To Tube (Inch)

Part Numbers	A Tube O.D.		A ₁ Tube O.D.		D		W		N		N ₁		N ₂		L		L ₁		I		Panel hole drill size		Max. Panel thickness	
	in	mm	in	mm	in	mm	in	mm	in	mm	in	mm	in	mm	in	mm	in	mm	in	mm	in	mm	in	mm
VUWRP-3.2X3.2	1/8	3.2	1/8	3.2	0.08	2	1/2	12.7	1.69	42.9	0.97	24.6	0.53	13.5	1.95	49.5	1.23	31.2	0.5	12.7	21/64	8.3	0.5	12.7
VUWRP-6.35X6.35	1/4	6.35	1/4	6.35	0.17	4.2	5/8	15.9	1.91	48.5	1.03	26.1	0.62	15.7	2.2	55.9	1.32	33.5	0.6	15.2	29/64	11.5	0.4	10.2
VUWRP-9.52X9.52	3/8	9.52	3/8	9.52	0.28	7.1	3/4	19.1	2.12	53.9	1.16	29.5	0.69	17.5	2.41	61.2	1.45	36.8	0.66	16.8	37/64	14.7	0.44	11.2
VUWRP-12.7X12.7	1/2	12.7	1/2	12.7	0.39	9.9	15/16	23.8	2.47	62.7	1.25	31.8	0.91	23.1	2.87	72.9	1.65	41.9	0.9	22.9	49/64	19.4	0.5	12.7

"D" - Dimension is minimum hole diameter - dimensions are for reference only, and are subject to change without notice.

Bulkhead Male Connectors (NPT)

HP

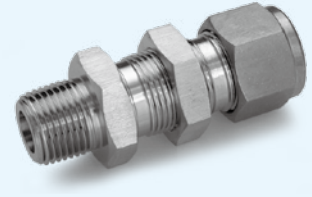
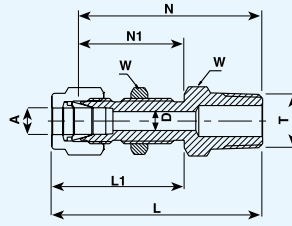

Tube (Metric) To Male NPT Thread

Part Numbers	A Tube O.D.		T	D		W		N		N1		L		L1		Panel hole drill size		Max. Panel thickness	
	mm	mm		mm	mm	mm	mm	mm	mm	mm	mm	mm	mm	mm	mm	mm	mm	mm	mm
VUWHP-6AN	6		1/8NPT	4.8		16		42.1		26.2		49.5		33.6		11.5		10.2	
VUWHP-6BN	6		1/4NPT	4.8		16		46.2		26.2		53.6		33.6		11.5		10.2	
VUWHP-12DN	12		1/2NPT	9.5		24		58.7		31.8		68.8		41.9		19.5		12.7	

Tube (Inch) To Male NPT Thread

Part Numbers	A Tube O.D.		T	D		W		N		N1		L		L1		Panel hole drill size		Max. Panel thickness	
	in	mm		in	mm	in	mm	in	mm	in	mm	in	mm	in	mm	in	mm	in	mm
	VUWHP-3.2AN	1/8		3.2	1/8NPT	0.09	2.3	1/2	12.7	1.57	39.9	0.97	24.6	1.83	46.5	1.23	31.2	21/64	8.3
VUWHP-6.35AN	1/4	6.35	1/8NPT	0.19	4.8	5/8	15.9	1.66	42.2	1.03	26.2	1.95	49.5	1.32	33.5	29/64	11.5	0.4	10.2
VUWHP-6.35BN	1/4	6.35	1/4NPT	0.19	4.8	5/8	15.9	1.84	46.7	1.03	26.2	2.13	54.1	1.32	33.5	29/64	11.5	0.4	10.2
VUWHP-9.52BN	3/8	9.52	1/4NPT	0.28	7.1	3/4	19.1	1.97	50	1.16	29.5	2.26	57.4	1.45	36.8	37/64	14.7	0.44	11.2
VUWHP-12.7CN	1/2	12.7	3/8NPT	0.4	10.4	15/16	23.8	2.09	53.1	1.25	31.8	2.49	83.3	1.65	41.9	49/64	19.4	0.5	12.7
VUWHP-12.7DN	1/2	12.7	1/2NPT	0.4	10.4	15/16	23.8	2.31	58.7	1.25	31.8	2.71	68.8	1.65	41.9	49/64	19.4	0.5	12.7

"D" - Dimension is minimum hole diameter - dimensions are for reference only, and are subject to change without notice.

Bulkhead Male Connectors (R)

HP

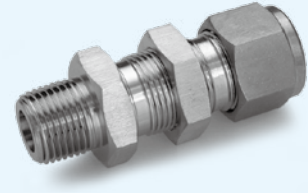
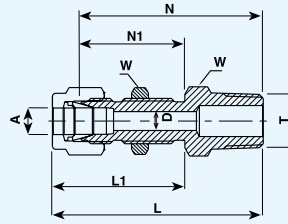

Tube (Metric) To ISO Tapered Thread

Part Numbers	A Tube O.D.		T	D		W		N		N1		L		L1		Panel hole drill size		Max. Panel thickness	
	in	mm		in	mm	in	mm	in	mm	in	mm	in	mm	in	mm	in	mm	in	mm
VUWHP-6A		6	R 1/8		4.8		16		42.1		26.2		49.5		33.6		11.5		10.2
VUWHP-6B		6	R 1/4		4.8		16		46.2		26.2		53.6		33.6		11.5		10.2
VUWHP-12D		12	R 1/2		9.5		24		58.7		31.8		68.8		41.9		19.5		12.7

Tube (Inch) To ISO Tapered Thread

Part Numbers	A Tube O.D.		T	D		W		N		N1		L		L1		Panel hole drill size		Max. Panel thickness	
	in	mm		in	mm	in	mm	in	mm	in	mm	in	mm	in	mm	in	mm	in	mm
VUWHP-3.2A	1/8	3.2	R 1/8	0.09	2.3	1/2	12.7	1.57	39.9	0.97	24.6	1.83	46.5	1.23	31.2	21/64	8.3	0.5	12.7
VUWHP-6.35A	1/4	6.35	R 1/8	0.19	4.8	5/8	15.9	1.66	42.2	1.03	26.2	1.95	49.5	1.32	33.5	29/64	11.5	0.4	10.2
VUWHP-6.35B	1/4	6.35	R 1/4	0.19	4.8	5/8	15.9	1.84	46.7	1.03	26.2	2.13	54.1	1.32	33.5	29/64	11.5	0.4	10.2
VUWHP-9.52B	3/8	9.52	R 1/4	0.28	7.1	3/4	19.1	1.97	50	1.16	29.5	2.26	57.4	1.45	36.8	37/64	14.7	0.44	11.2
VUWHP-12.7C	1/2	12.7	R 3/8	0.4	10.4	15/16	23.8	2.09	53.1	1.25	31.8	2.49	83.3	1.65	41.9	49/64	19.4	0.5	12.7
VUWHP-12.7D	1/2	12.7	R 1/2	0.4	10.4	15/16	23.8	2.31	58.7	1.25	31.8	2.71	68.8	1.65	41.9	49/64	19.4	0.5	12.7

Designation:

R marking on hex.

"D" - Dimension is minimum hole diameter - dimensions are for reference only, and are subject to change without notice.

Union Crosses

X

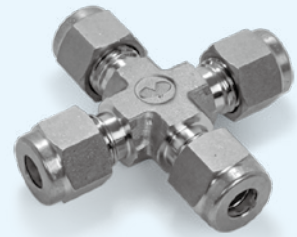
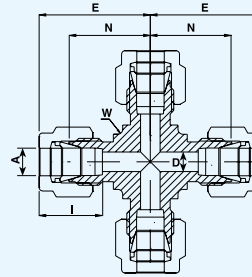

All Tubes (Metric)

Part Numbers	A Tube O.D.		D		W		N		E		I	
	mm	mm	mm	mm	in	mm	mm	mm	mm	mm	mm	mm
VUWX-3	3		2.4		3/8	9.5		15.7		22.3		12.9
VUWX-6	6		4.8		1/2	12.7		19.6		27		15.3
VUWX-8	8		6.4		5/8	15.9		22.4		29.9		16.2
VUWX-10	10		7.9		13/16	20.6		25.9		33.5		17.2
VUWX-12	12		9.5		13/16	20.6		25.9		36		22.8
VUWX-18	18		15.1		1 1/16	27		28.2		38.3		24.4
VUWX-20	20		15.9		1 3/8	34.9		34.5		44.6		26

All Tubes (Inch)

Part Numbers	A Tube O.D.		D		W		N		E		I	
	in	mm	in	mm	in	mm	in	mm	in	mm	in	mm
VUWX-3.2	1/8	3.2	0.09	2.3	3/8	9.5	0.62	15.8	0.88	22.4	0.5	12.7
VUWX-6.35	1/4	6.35	0.19	4.8	1/2	12.7	0.77	19.6	1.06	26.9	0.6	15.2
VUWX-7.93	5/16	7.93	0.25	6.4	5/8	15.9	0.88	22.4	1.17	29.7	0.64	16.2
VUWX-9.52	3/8	9.52	0.28	7.1	5/8	15.9	0.91	23.1	1.2	30.5	0.66	16.8
VUWX-12.7	1/2	12.7	0.41	10.4	13/16	20.6	1.02	25.9	1.42	36.1	0.9	22.9
VUWX-19.05	3/4	19.05	0.62	15.8	1 1/16	27	1.17	29.7	1.57	39.9	0.96	24.4
VUWX-25.4	1	25.4	0.88	22.3	1 3/8	34.9	1.45	36.8	1.93	49	1.23	31.2

"D" - Dimension is minimum hole diameter - dimensions are for reference only, and are subject to change without notice.

Caps

JC

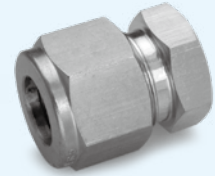
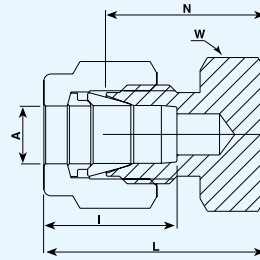

Capping End Of Tube (Metric)

Part Numbers	A Tube O.D.		W		N		L		I	
	mm	mm	mm	mm	mm	mm	mm	mm	mm	mm
VUWJC-2	2		12		13.5		20.1		12.9	
VUWJC-3	3		12		13.5		20.1		12.9	
VUWJC-4	4		12		14.7		21.3		13.7	
VUWJC-6	6		14		15.7		23.1		15.3	
VUWJC-8	8		15		17		24.5		16.2	
VUWJC-10	10		18		19		26.6		17.2	
VUWJC-12	12		22		19		29.1		22.8	
VUWJC-15	15		24		19.8		29.9		24.4	
VUWJC-16	16		24		19.8		29.9		24.4	
VUWJC-18	18		27		21.3		31.4		24.4	
VUWJC-20	20		30		23.9		34		26	
VUWJC-22	22		30		23.9		34		26	
VUWJC-25	25		35		26.2		38.5		31.3	

Capping End Of Tube (Inch)

Part Numbers	A Tube O.D.		W		N		L		I	
	in	mm	in	mm	in	mm	in	mm	in	mm
VUWJC-1.6	1/16	1.6	5/16	7.9	0.44	11.2	0.59	15	0.34	8.6
VUWJC-3.2	1/8	3.2	7/16	11.1	0.53	13.5	0.79	20.1	0.5	12.7
VUWJC-4.8	3/16	4.8	7/16	11.1	0.58	14.7	0.84	21.8	0.54	13.7
VUWJC-6.35	1/4	6.35	1/2	12.7	0.63	16	0.92	23.4	0.6	15.2
VUWJC-7.93	5/16	7.93	9/16	14.3	0.67	17	0.96	24.4	0.64	16.2
VUWJC-9.52	3/8	9.52	5/8	15.9	0.72	18.3	1.01	26.7	0.66	16.8
VUWJC-12.7	1/2	12.7	13/16	20.6	0.75	19.1	1.15	29.2	0.9	22.9
VUWJC-15.88	5/8	15.88	15/16	23.8	0.78	19.8	1.18	30	0.96	24.4
VUWJC-19.05	3/4	19.05	1 1/16	27	0.84	21.3	1.24	31.5	0.96	24.4
VUWJC-22.22	7/8	22.22	1 3/16	30.2	0.94	23.9	1.34	34	1.02	25.9
VUWJC-25.4	1	25.4	1 3/8	34.9	1.03	26.2	1.51	38.4	1.23	31.2

Plugs

JP

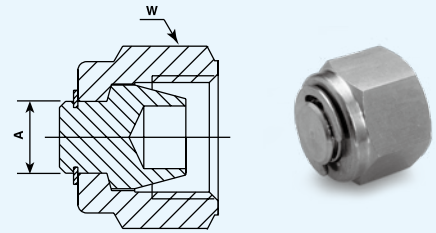

Plugging Unused Port Of Fitting (Metric)

Part Numbers	A		W	
	mm	mm	mm	mm
VUWJP-3	3		12	
VUWJP-4	4		12	
VUWJP-6	6		14	
VUWJP-8	8		16	
VUWJP-10	10		19	
VUWJP-12	12		22	
VUWJP-15	15		25	
VUWJP-16	16		25	
VUWJP-18	18		30	
VUWJP-20	20		32	
VUWJP-22	22		32	
VUWJP-25	25		38	

Plugging Unused Port Of Fitting (Inch)

Part Numbers	A		W	
	in	mm	in	mm
VUWJP-1.6	1/16	1.5	5/16	7.9
VUWJP-3.2	1/8	3.1	7/16	11.1
VUWJP-4.8	3/16	4.8	1/2	12.7
VUWJP-6.35	1/4	6.35	9/16	14.3
VUWJP-7.93	5/16	7.93	5/8	15.9
VUWJP-9.52	3/8	9.52	11/16	17.5
VUWJP-12.7	1/2	12.7	7/8	22.2
VUWJP-15.88	5/8	15.8	1	25.4
VUWJP-19.05	3/4	19	1 1/8	28.6
VUWJP-25.4	1	25.4	1 1/2	38.1

Plug Assembly Instructions

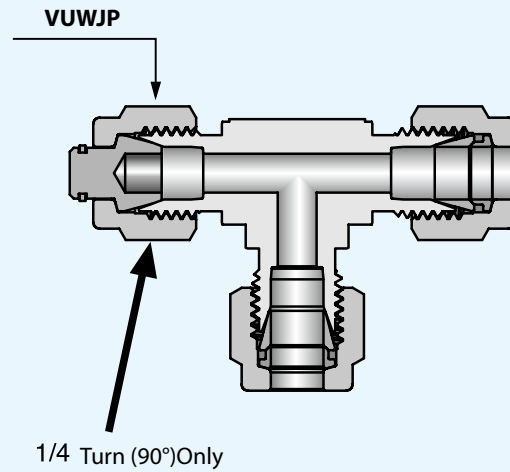

Female Adapters Tube To Pipe (NPT) GA

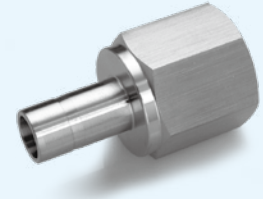
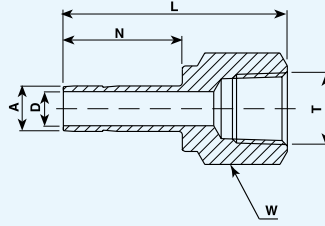

Tube (Metric) Female Pipe

Part Numbers	A Tube O.D.	T	D	W	N	L
	mm		mm	mm	mm	mm
VUW-GA-3AN	3	1/8NPT	2.1	14	13.5	31.5
VUW-GA-3BN	3	1/4NPT	2.1	19	13.5	35.3
VUW-GA-4BN	4	1/4NPT	2.2	19	14.2	35
VUW-GA-6AN	6	1/8NPT	4	14	15.7	32.5
VUW-GA-6BN	6	1/4NPT	4	19	15.7	37.1
VUW-GA-6CN	6	3/8NPT	4	22	15.7	39.6
VUW-GA-6DN	6	1/2NPT	4	27	15.7	45.5
VUW-GA-8AN	8	1/8NPT	5.6	14	16.8	34.3
VUW-GA-8BN	8	1/4NPT	5.6	19	16.8	37.6
VUW-GA-8DN	8	1/2NPT	5.6	27	16.8	46
VUW-GA-10BN	10	1/4NPT	7.1	19	17.5	38.1
VUW-GA-10CN	10	3/8NPT	7.1	22	17.5	40.1
VUW-GA-10DN	10	1/2NPT	7.1	27	17.5	46.5
VUW-GA-12BN	12	1/4NPT	8.8	19	23.1	43.7
VUW-GA-12CN	12	3/8NPT	8.8	22	23.1	45.5
VUW-GA-12DN	12	1/2NPT	8.8	27	23.1	52.3
VUW-GA-16CN	16	3/8NPT	12.7	24	24.7	48
VUW-GA-16DN	16	1/2NPT	12.7	27	24.7	53.1
VUW-GA-20DN	20	1/2NPT	15.1	27	26.6	56
VUW-GA-20EN	20	3/4NPT	15.1	35	26.6	56

"D" - Dimension is minimum hole diameter - dimensions are for reference only, and are subject to change without notice.

Female Adapters Tube To Pipe (NPT) (continued)

GA

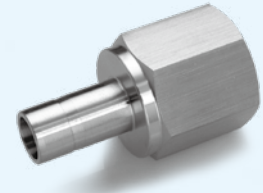
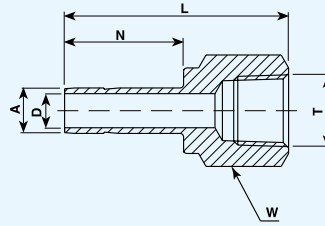

Part Numbers	A Tube O.D.		T	D		W		N		L	
	in	mm		in	mm	in	mm	in	mm	in	mm
	VUW-GA-3.2AN	1/8		3.2	1/8NPT	0.08	2.3	9/16	14.3	0.53	13.5
VUW-GA-3.2BN	1/8	3.2	1/4NPT	0.08	2.3	3/4	19.1	0.53	13.5	1.39	35.3
VUW-GA-4.8BN	3/16	4.8	1/4NPT	0.12	3	3/4	19.1	0.56	14.2	1.41	35.8
VUW-GA-6.35AN	1/4	6.35	1/8NPT	0.17	4.2	9/16	14.3	0.62	15.8	1.3	33
VUW-GA-6.35BN	1/4	6.35	1/4NPT	0.17	4.2	3/4	19.1	0.62	15.8	1.46	37.1
VUW-GA-6.35CN	1/4	6.35	3/8NPT	0.17	4.2	7/8	22.2	0.62	15.8	1.55	39.4
VUW-GA-6.35DN	1/4	6.35	1/2NPT	0.17	4.2	1 1/16	27	0.62	15.8	1.79	45.5
VUW-GA-7.93BN	5/16	7.93	1/4NPT	0.24	6	3/4	19.1	0.66	16.8	1.48	37.6
VUW-GA-9.52AN	3/8	9.52	1/8NPT	0.28	7.1	9/16	14.3	0.69	17.5	1.35	34.3
VUW-GA-9.52BN	3/8	9.52	1/4NPT	0.27	6.9	3/4	19.1	0.69	17.5	1.5	38.1
VUW-GA-9.52CN	3/8	9.52	3/8NPT	0.27	6.9	7/8	22.2	0.69	17.5	1.59	40.4
VUW-GA-9.52DN	3/8	9.52	1/2NPT	0.27	6.9	1 1/16	27	0.69	17.5	1.84	46.7
VUW-GA-12.7BN	1/2	12.7	1/4NPT	0.37	9.4	3/4	19.1	0.91	23.1	1.71	43.4
VUW-GA-12.7CN	1/2	12.7	3/8NPT	0.37	9.4	7/8	22.2	0.91	23.1	1.79	45.5
VUW-GA-12.7DN	1/2	12.7	1/2NPT	0.37	9.4	1 1/16	27	0.91	23.1	2.04	52.1
VUW-GA-15.88DN	5/8	15.88	1/2NPT	0.5	12.7	1 1/16	27	0.97	24.7	2.09	53.1
VUW-GA-19.05DN	3/4	19.05	1/2NPT	0.59	15	1 1/16	27	0.97	24.7	2.08	52.8
VUW-GA-19.05EN	3/4	19.05	3/4NPT	0.59	15	1 5/16	33.3	0.97	24.7	2.16	54.9
VUW-GA-19.05FN	3/4	19.05	1NPT	0.59	15	1 5/8	41.3	0.97	24.7	2.3	58.4
VUW-GA-25.4EN	1	25.4	3/4NPT	0.8	20.3	1 5/16	33.3	1.23	31.2	2.39	60.7
VUW-GA-25.4FN	1	25.4	1NPT	0.8	20.3	1 5/8	41.3	1.23	31.2	2.53	64.3

"D" - Dimension is minimum hole diameter - dimensions are for reference only, and are subject to change without notice.

Female Adapters Tube To Pipe (Rc) GA

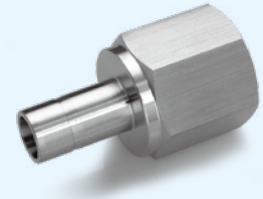
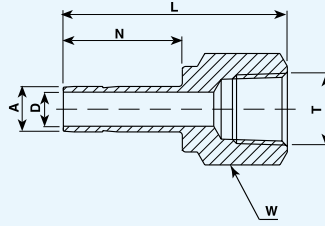

Tube (Metric) To ISO Tapered Thread

Part Numbers	A Tube O.D.	T	D	W	N	L
	mm		mm	mm	mm	mm
VUW-GA-3A	3	Rc 1/8	2.1	14	13.5	31.5
VUW-GA-3B	3	Rc 1/4	2.1	19	13.5	35.3
VUW-GA-4B	4	Rc 1/4	2.2	19	14.2	35
VUW-GA-6A	6	Rc 1/8	4	14	15.7	32.5
VUW-GA-6B	6	Rc 1/4	4	19	15.7	37.1
VUW-GA-6C	6	Rc 3/8	4	22	15.7	39.6
VUW-GA-6D	6	Rc 1/2	4	27	15.7	45.5
VUW-GA-8A	8	Rc 1/8	5.6	14	16.8	34.3
VUW-GA-8B	8	Rc 1/4	5.6	19	16.8	37.6
VUW-GA-8D	8	Rc 1/2	5.6	27	16.8	46
VUW-GA-10B	10	Rc 1/4	7.1	19	17.5	38.1
VUW-GA-10C	10	Rc 3/8	7.1	22	17.5	40.1
VUW-GA-10D	10	Rc 1/2	7.1	27	17.5	46.5
VUW-GA-12B	12	Rc 1/4	8.8	19	23.1	43.7
VUW-GA-12C	12	Rc 3/8	8.8	22	23.1	45.5
VUW-GA-12D	12	Rc 1/2	8.8	27	23.1	52.3
VUW-GA-16C	16	Rc 3/8	12.7	24	24.7	48
VUW-GA-16D	16	Rc 1/2	12.7	27	24.7	53.1
VUW-GA-20D	20	Rc 1/2	15.1	27	26.6	56
VUW-GA-20E	20	Rc 3/4	15.1	35	26.6	56

Designation:

R marking on hex.

"D" - Dimension is minimum hole diameter - dimensions are for reference only, and are subject to change without notice.

Female Adapters Tube To Pipe (Rc) (continued)

GA

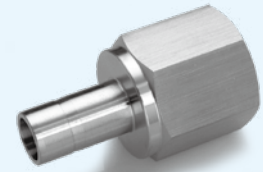
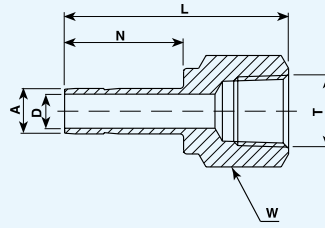

Tube (Inch) To ISO Tapered Thread

Part Numbers	A Tube O.D.		T	D		W		N		L	
	in	mm		in	mm	in	mm	in	mm	in	mm
VUW-GA-3.2A	1/8	3.2	Rc 1/8	0.08	2.3	9/16	14.3	0.53	13.5	1.24	31.5
VUW-GA-3.2B	1/8	3.2	Rc 1/4	0.08	2.3	3/4	19.1	0.53	13.5	1.39	35.3
VUW-GA-4.8B	3/16	4.8	Rc 1/4	0.12	3	3/4	19.1	0.56	14.2	1.41	35.8
VUW-GA-6.35A	1/4	6.35	Rc 1/8	0.17	4.2	9/16	14.3	0.62	15.8	1.30	33
VUW-GA-6.35B	1/4	6.35	Rc 1/4	0.17	4.2	3/4	19.1	0.62	15.8	1.46	37.1
VUW-GA-6.35C	1/4	6.35	Rc 3/8	0.17	4.2	7/8	22.2	0.62	15.8	1.55	39.4
VUW-GA-6.35D	1/4	6.35	Rc 1/2	0.17	4.2	1 1/16	27	0.62	15.8	1.79	45.5
VUW-GA-7.93B	5/16	7.93	Rc 1/4	0.24	6	3/4	19.1	0.66	16.8	1.48	37.6
VUW-GA-9.52A	3/8	9.52	Rc 1/8	0.28	7.1	9/16	14.3	0.69	17.5	1.35	34.3
VUW-GA-9.52B	3/8	9.52	Rc 1/4	0.27	6.9	3/4	19.1	0.69	17.5	1.5	38.1
VUW-GA-9.52C	3/8	9.52	Rc 3/8	0.27	6.9	7/8	22.2	0.69	17.5	1.59	40.4
VUW-GA-9.52D	3/8	9.52	Rc 1/2	0.27	6.9	1 1/16	27	0.69	17.5	1.84	46.7
VUW-GA-12.7B	1/2	12.7	Rc 1/4	0.37	9.4	3/4	19.1	0.91	23.1	1.71	43.4
VUW-GA-12.7C	1/2	12.7	Rc 3/8	0.37	9.4	7/8	22.2	0.91	23.1	1.79	45.5
VUW-GA-12.7D	1/2	12.7	Rc 1/2	0.37	9.4	1 1/16	27	0.91	23.1	2.04	52.1
VUW-GA-15.88D	5/8	15.88	Rc 1/2	0.5	12.7	1 1/16	27	0.97	24.7	2.09	53.1
VUW-GA-19.05D	3/4	19.05	Rc 1/2	0.59	15	1 1/16	27	0.97	24.7	2.08	52.8
VUW-GA-19.05E	3/4	19.05	Rc 3/4	0.59	15	1 5/16	33.3	0.97	24.7	2.16	54.9
VUW-GA-19.05F	3/4	19.05	Rc 1	0.59	15	1 5/8	41.3	0.97	24.7	2.3	58.4
VUW-GA-25.4E	1	25.4	Rc 3/4	0.8	20.3	1 5/16	33.3	1.23	31.2	2.39	60.7
VUW-GA-25.4F	1	25.4	Rc 1	0.8	20.3	1 5/8	41.3	1.23	31.2	2.53	64.3

Designation:

R marking on hex.

"D" - Dimension is minimum hole diameter - dimensions are for reference only, and are subject to change without notice.

Male Adapters Tube To Pipe (NPT)

A

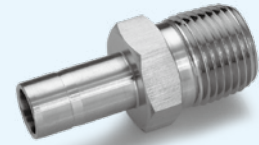
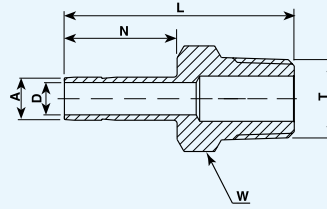

Tube (Metric) Male Pipe

Part Numbers	A Tube O.D.	T	D	W		N	L
	mm		mm	in	mm	mm	mm
VUW-A-3AN	3	1/8NPT	2.1	-	12	13.5	30
VUW-A-3BN	3	1/4NPT	2.1	-	14	13.5	35.3
VUW-A-6AN	6	1/8NPT	4	-	12	15.7	32.8
VUW-A-6BN	6	1/4NPT	4	-	14	15.7	38.1
VUW-A-6CN	6	3/8NPT	4	11/16	17.5	15.7	37
VUW-A-6DN	6	1/2NPT	4	-	22	15.7	43.4
VUW-A-8AN	8	1/8NPT	5.6	-	12	16.8	33.5
VUW-A-8BN	8	1/4NPT	5.6	-	14	16.8	39.1
VUW-A-8DN	8	1/2NPT	5.6	-	22	16.8	43
VUW-A-10BN	10	1/4NPT	7.1	9/16	14	17.5	39.9
VUW-A-10CN	10	3/8NPT	7.1	-	18	17.5	40.6
VUW-A-10DN	10	1/2NPT	7.1	-	22	17.5	46.2
VUW-A-12BN	12	1/4NPT	8.8	-	16	23.1	46.5
VUW-A-12CN	12	3/8NPT	8.8	-	18	23.1	46.5
VUW-A-12DN	12	1/2NPT	8.8	-	22	23.1	52
VUW-A-16DN	16	1/2NPT	11.9	-	22	24.7	50.5
VUW-A-20EN	20	3/4NPT	15.1	-	27	26.6	54.3

"D" - Dimension is minimum hole diameter - dimensions are for reference only, and are subject to change without notice.

Male Adapters Tube To Pipe (NPT) (continued)

A

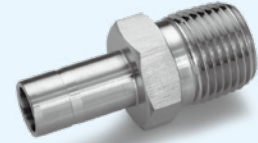
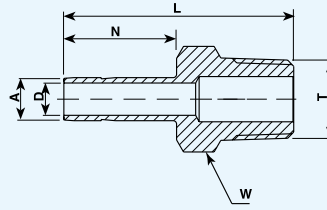

Tube (Inch) Male Pipe

Part Numbers	A Tube O.D.		T	D		W		N		L	
	in	mm		in	mm	in	mm	in	mm	in	mm
VUW-A-3.2AN	1/8	3.2	1/8NPT	0.09	2.2	7/16	11.1	0.53	13.5	1.16	29.5
VUW-A-3.2BN	1/8	3.2	1/4NPT	0.09	2.2	9/16	14.3	0.53	13.5	1.37	34.8
VUW-A-4.8AN	3/16	4.8	1/8NPT	0.12	3	7/16	11.1	0.56	14.2	1.19	30.2
VUW-A-4.8BN	3/16	4.8	1/4NPT	0.12	3	9/16	14.3	0.56	14.2	1.4	35.6
VUW-A-6.35AN	1/4	6.35	1/8NPT	0.17	4.2	7/16	11.1	0.62	15.8	1.25	31.8
VUW-A-6.35BN	1/4	6.35	1/4NPT	0.17	4.2	9/16	14.3	0.62	15.8	1.46	37.1
VUW-A-6.35CN	1/4	6.35	3/8NPT	0.17	4.2	11/16	17.5	0.62	15.8	1.49	37.9
VUW-A-6.35DN	1/4	6.35	1/2NPT	0.17	4.2	7/8	22.2	0.62	15.8	1.71	43.4
VUW-A-7.93AN	5/16	7.93	1/8NPT	0.24	6	7/16	11.1	0.66	16.8	1.29	32.7
VUW-A-7.93BN	5/16	7.93	1/4NPT	0.24	6	9/16	14.3	0.66	16.8	1.5	38.1
VUW-A-9.52AN	3/8	9.52	1/8NPT	0.27	6.9	7/16	11.1	0.69	17.5	1.32	33.5
VUW-A-9.52BN	3/8	9.52	1/4NPT	0.27	6.9	9/16	14.3	0.69	17.5	1.53	38.9
VUW-A-9.52CN	3/8	9.52	3/8NPT	0.27	6.9	11/16	17.5	0.69	17.5	1.56	39.6
VUW-A-9.52DN	3/8	9.52	1/2NPT	0.27	6.9	7/8	22.2	0.69	17.5	1.78	45.2
VUW-A-12.7BN	1/2	12.7	1/4NPT	0.37	9.4	9/16	14.3	0.91	23.1	1.75	44.5
VUW-A-12.7CN	1/2	12.7	3/8NPT	0.37	9.4	11/16	17.5	0.91	23.1	1.78	45.2
VUW-A-12.7DN	1/2	12.7	1/2NPT	0.37	9.4	7/8	22.2	0.91	23.1	2	50.8
VUW-A-15.88CN	5/8	15.88	3/8NPT	0.37	9.5	11/16	17.5	0.97	24.7	1.81	47.6
VUW-A-15.88DN	5/8	15.88	1/2NPT	0.47	11.9	7/8	22.2	0.97	24.7	2.06	52.3
VUW-A-15.88EN	5/8	15.88	3/4NPT	0.5	12.7	1 1/16	27	0.97	24.7	2.06	52.3
VUW-A-19.05DN	3/4	19.05	1/2NPT	0.47	11.9	7/8	22.2	0.97	24.7	2.06	52.3
VUW-A-19.05EN	3/4	19.05	3/4NPT	0.59	15	1 1/16	27	0.97	24.7	2.06	52.3
VUW-A-19.05FN	3/4	19.05	1NPT	0.59	15	1 3/8	34.9	0.97	24.7	2.28	57.3
VUW-A-22.22EN	7/8	22.22	3/4NPT	0.6	15.9	1 1/16	27	1.05	26.6	2.09	54.3
VUW-A-25.4EN	1	25.4	3/4NPT	0.62	15.8	1 1/16	27	1.3	33	2.31	58.7
VUW-A-25.4FN	1	25.4	1NPT	0.8	20.3	1 3/8	34.9	1.3	33	2.6	66.4

V-Lok Tube Fittings Male Adapters Tube To Pipe (NPT) (continued)

"D" - Dimension is minimum hole diameter - dimensions are for reference only, and are subject to change without notice.

Male Adapters Tube To Pipe (R)

A

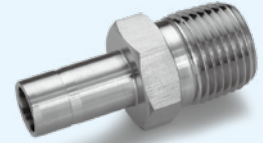
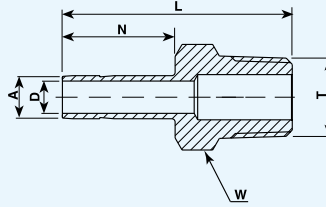

Tube (Metric) To ISO Tapered Thread

Part Numbers	A Tube O.D.	T	D	W		N	L
	mm		mm	in	mm	mm	mm
VUW-A-3A	3	R 1/8	2.1	-	12	13.5	30
VUW-A-3B	3	R 1/4	2.1	-	14	13.5	35.3
VUW-A-6A	6	R 1/8	4	-	12	15.7	32.8
VUW-A-6B	6	R 1/4	4	-	14	15.7	38.1
VUW-A-6C	6	R 3/8	4	11/16	17.5	15.7	37
VUW-A-6D	6	R 1/2	4	-	22	15.7	43.4
VUW-A-8A	8	R 1/8	5.6	-	12	16.8	33.5
VUW-A-8B	8	R 1/4	5.6	-	14	16.8	39.1
VUW-A-8D	8	R 1/2	5.6	-	22	16.8	43
VUW-A-10B	10	R 1/4	7.1	9/16	14	17.5	39.9
VUW-A-10C	10	R 3/8	7.1	-	18	17.5	40.6
VUW-A-10D	10	R 1/2	7.1	-	22	17.5	46.2
VUW-A-12B	12	R 1/4	8.8	-	16	23.1	46.5
VUW-A-12C	12	R 3/8	8.8	-	18	23.1	46.5
VUW-A-12D	12	R 1/2	8.8	-	22	23.1	52
VUW-A-16D	16	R 1/2	11.9	-	22	24.7	50.5
VUW-A-20E	20	R 3/4	15.1	-	27	26.6	54.3

"D" - Dimension is minimum hole diameter - dimensions are for reference only, and are subject to change without notice.

Male Adapters Tube To Pipe (R) (continued)

A

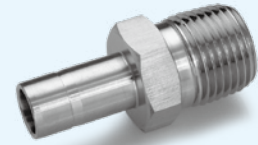
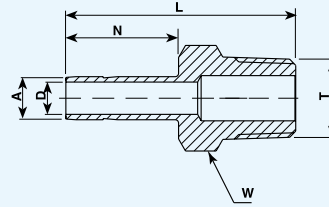

V-Lok Tube Fittings Male Adapters Tube To Pipe (R) (continued)

Tube (Inch) To ISO Tapered Thread											
Part Numbers	A Tube O.D.		T	D		W		N		L	
	in	mm		in	mm	in	mm	in	mm	in	mm
VUW-A-3.2A	1/8	3.2	R 1/8	0.09	2.2	7/16	11.1	0.53	13.5	1.16	29.5
VUW-A-3.2B	1/8	3.2	R 1/4	0.09	2.2	9/16	14.3	0.53	13.5	1.37	34.8
VUW-A-4.8A	3/16	4.8	R 1/8	0.12	3	7/16	11.1	0.56	14.2	1.19	30.2
VUW-A-4.8B	3/16	4.8	R 1/4	0.12	3	9/16	14.3	0.56	14.2	1.4	35.6
VUW-A-6.35A	1/4	6.35	R 1/8	0.17	4.2	7/16	11.1	0.62	15.8	1.25	31.8
VUW-A-6.35B	1/4	6.35	R 1/4	0.17	4.2	9/16	14.3	0.62	15.8	1.46	37.1
VUW-A-6.35C	1/4	6.35	R 3/8	0.17	4.2	11/16	17.5	0.62	15.8	1.49	37.9
VUW-A-6.35D	1/4	6.35	R 1/2	0.17	4.2	7/8	22.2	0.62	15.8	1.71	43.4
VUW-A-7.93A	5/16	7.93	R 1/8	0.24	6	7/16	11.1	0.66	16.8	1.29	32.7
VUW-A-7.93B	5/16	7.93	R 1/4	0.24	6	9/16	14.3	0.66	16.8	1.5	38.1
VUW-A-9.52A	3/8	9.52	R 1/8	0.27	6.9	7/16	11.1	0.69	17.5	1.32	33.5
VUW-A-9.52B	3/8	9.52	R 1/4	0.27	6.9	9/16	14.3	0.69	17.5	1.53	38.9
VUW-A-9.52C	3/8	9.52	R 3/8	0.27	6.9	11/16	17.5	0.69	17.5	1.56	39.6
VUW-A-9.52D	3/8	9.52	R 1/2	0.27	6.9	7/8	22.2	0.69	17.5	1.78	45.2
VUW-A-12.7B	1/2	12.7	R 1/4	0.37	9.4	9/16	14.3	0.91	23.1	1.75	44.5
VUW-A-12.7C	1/2	12.7	R 3/8	0.37	9.4	11/16	17.5	0.91	23.1	1.78	45.2
VUW-A-12.7D	1/2	12.7	R 1/2	0.37	9.4	7/8	22.2	0.91	23.1	2	50.8
VUW-A-15.88C	5/8	15.88	R 3/8	0.37	9.5	11/16	17.5	0.97	24.7	1.81	47.6
VUW-A-15.88D	5/8	15.88	R 1/2	0.47	11.9	7/8	22.2	0.97	24.7	2.06	52.3
VUW-A-15.88E	5/8	15.88	R 3/4	0.5	12.7	1 1/16	27	0.97	24.7	2.06	52.3
VUW-A-19.05D	3/4	19.05	R 1/2	0.47	11.9	7/8	22.2	0.97	24.7	2.06	52.32
VUW-A-19.05E	3/4	19.05	R 3/4	0.59	15	1 1/16	27	0.97	24.7	2.06	52.32
VUW-A-19.05F	3/4	19.05	R 1	0.59	15	1 3/8	34.9	0.97	24.7	2.28	57.3
VUW-A-22.22E	7/8	22.22	R 3/4	0.6	15.9	1 1/16	27	1.05	26.6	2.09	54.3
VUW-A-25.4E	1	25.4	R 3/4	0.62	15.8	1 1/16	27	1.3	33	2.31	58.7
VUW-A-25.4F	1	25.4	R 1	0.8	20.3	1 3/8	34.9	1.3	33	2.6	66.4

"D" - Dimension is minimum hole diameter - dimensions are for reference only, and are subject to change without notice.

Chromatograph Fittings

Male Nuts

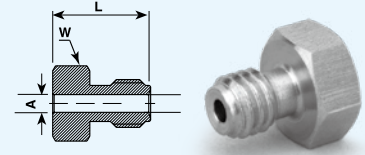

Part Number	A Tube O.D.		W		L	
	in	mm	in	mm	in	mm
VUW-1.6MN	1/16	1.6	1/4	6.4	3/8	9.5

Unions

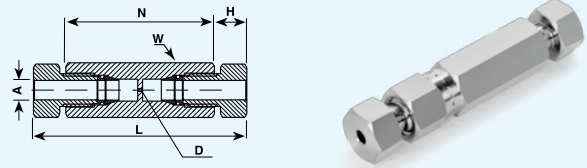

Part Number	A Tube O.D.		D		W		N		H		L		Dead Space
	in	mm	in	mm	in	mm	in	mm	in	mm	in	mm	
VUWF-1.6-MN	1/16	1.6	0.013	0.3	1/4	6.4	0.84	21.3	0.2	5.1	1.24	31.5	6.6 x 10 ⁻⁶ cc

Reducing Unions

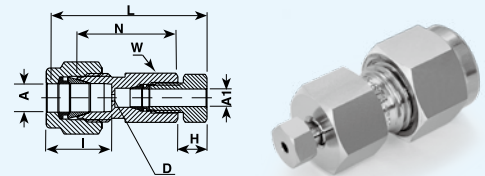

Part Numbers	A Tube O.D.		A1 Tube O.D.		D		W		N		L		H		I		Dead Space
	in	mm	in	mm	in	mm	in	mm	in	mm	in	mm	in	mm	in	mm	
VUWF-6.35X1.6-MN	1/4	6.35	1/16	1.6	0.013	0.3	1/2	12.7	0.75	19.1	1.24	31.5	0.2	5.1	0.6	15.2	6.8 x 10 ⁻⁶ cc
VUWF-9.52X1.6-MN	3/8	9.52	1/16	1.6	0.013	0.3	5/8	15.9	0.81	20.6	1.3	33.1	0.2	5.1	0.66	16.8	6.8 x 10 ⁻⁶ cc

Union Tees

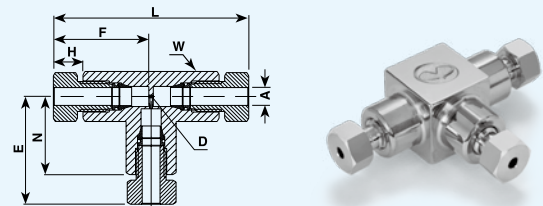

Part Number	A Tube O.D.		D		W		N		H		F		E		L		Dead Space
	in	mm	in	mm	in	mm	in	mm	in	mm	in	mm	in	mm	in	mm	
VUWT-1.6-MN	1/16	1.6	0.013	0.3	3/8	9.5	0.45	11.4	0.2	5.1	0.61	15.5	0.65	16.5	1.3	33	2.8 x 10 ⁻⁶ cc

"D" - Dimension is minimum hole diameter - dimensions are for reference only, and are subject to change without notice.

Positionables PER SAE J1926 & MS 16142

Male Elbows

PL

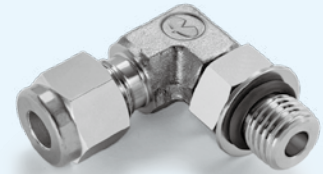
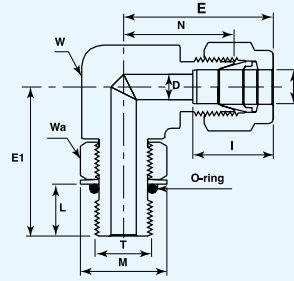

Tube To SAE/MS Straight Thread Boss (Positionable) ※

Part Numbers	A Tube O.D.		T	D		W		Wa		N		E		E1		L		M		I		O-ring ※※ size AS568
	in	mm		in	mm	in	mm	in	mm	in	mm	in	mm	in	mm	in	mm	in	mm	in	mm	
VUWPL-6.35X7/16	1/4	6.35	7/16-20	0.19	4.8	1/2	12.7	9/16	14.3	0.79	20	1.08	27.4	1.12	28.5	0.39	9.9	0.65	16.5	0.6	15.2	-904
VUWPL-6.35X9/16	1/4	6.35	9/16-18	0.19	4.8	5/8	15.9	11/16	17.5	0.91	23.11	1.2	30.48	1.27	32.3	0.44	11	0.79	20.1	0.6	15.2	-906
VUWPL-9.52X9/16	3/8	9.52	9/16-18	0.28	7.1	5/8	15.9	11/16	17.5	0.97	24.6	1.26	32	1.27	32.3	0.44	11	0.79	20.1	0.66	16.8	-906

Male Elbows 45°

PL

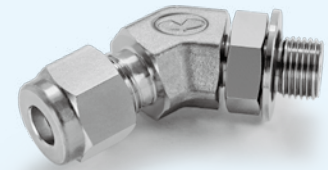
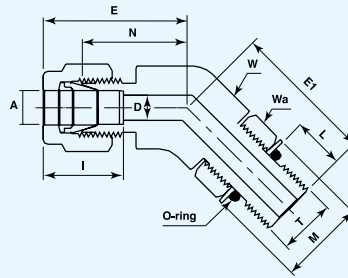

Tube To SAE/MS Straight Thread Boss (Positionable) ※

Part Numbers	A Tube O.D.		T	D		W		Wa		N		E		E1		L		M		I		O-ring ※※ size AS568
	in	mm		in	mm	in	mm	in	mm	in	mm	in	mm	in	mm	in	mm	in	mm	in	mm	
VUWPL-6.35X7/16-45	1/4	6.35	7/16-20	0.19	4.8	9/16	14.3	9/16	14.3	0.72	18.3	1.01	25.7	1.01	25.7	0.39	9.9	0.65	16.5	0.6	15.2	-904
VUWPL-9.52X9/16-45	3/8	9.52	9/16-18	0.28	7.1	13/16	20.6	11/16	17.5	0.81	20.1	1.1	28	1.06	27	0.44	11.2	0.79	20.1	0.66	16.8	-906

※ : Per SAE J1926 and MS 16142. See page 78 for mounting dimensions.

※※ : O-rings used are Viton 90 Durometer. Other O-ring materials are available on request.

"D" - Dimension is minimum hole diameter - dimensions are for reference only, and are subject to change without notice.

Positionables PER SAE J1926 & MS 16142

Male Run Tees

PTL

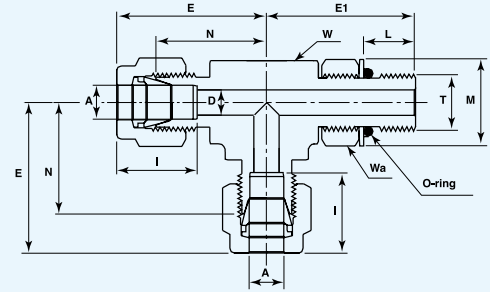

Tube To SAE/MS Straight Thread Boss (Positionable) ※

Part Numbers	A Tube O.D.		T	D		W		Wa		N		E		E1		L		M		I		O-ring ※※ size AS568
	in	mm		in	mm	in	mm	in	mm	in	mm	in	mm	in	mm	in	mm	in	mm	in	mm	
VUWPTL-6.35X7/16	1/4	6.35	7/16-20	0.19	4.8	1/2	12.7	9/16	14.3	0.83	21.1	1.12	28.5	1.12	28.5	0.39	9.9	0.65	16.5	0.6	15.2	-904
VUWPTL-9.52X9/16	3/8	9.52	9/16-18	0.28	7.1	5/8	15.9	11/16	17.5	0.97	24.6	1.26	32	1.27	32.3	0.44	11.2	0.79	20.1	0.66	16.8	-906

V-Lok Tube Fittings Male Run Tees / Male Branch tees

Male Branch tees

PTS

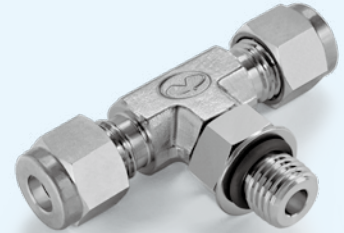
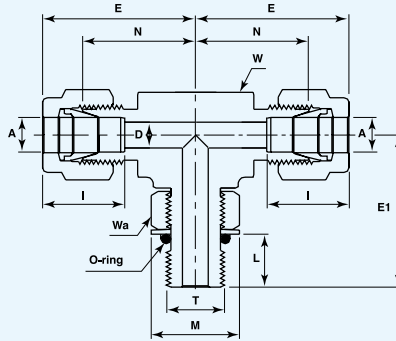

Tube To SAE/MS Straight Thread Boss (Positionable) ※

Part Numbers	A Tube O.D.		T	D		W		Wa		N		E		E1		L		M		I		O-ring ※※ size AS568
	in	mm		in	mm	in	mm	in	mm	in	mm	in	mm	in	mm	in	mm	in	mm	in	mm	
VUWPTS-6.35X7/16	1/4	6.35	7/16-20	0.19	4.8	1/2	12.7	9/16	14.3	0.83	21.1	1.12	28.5	1.12	28.5	0.39	9.9	0.65	16.5	0.6	15.2	-904
VUWPTS-9.52X9/16	3/8	9.52	9/16-18	0.28	7.1	5/8	15.9	11/16	17.5	0.97	24.6	1.26	32	1.27	32.3	0.44	11.2	0.79	20.1	0.66	16.8	-906

※ : Per SAE J1926 and MS 16142. See page 78 for mounting dimensions.

※※ : O-rings used are Viton 90 Durometer. Other O-ring materials are available on request.

"D" - Dimension is minimum hole diameter - dimensions are for reference only, and are subject to change without notice.

Mounting Dimensions FOR SAE J1926 & MS 16142 BOSS

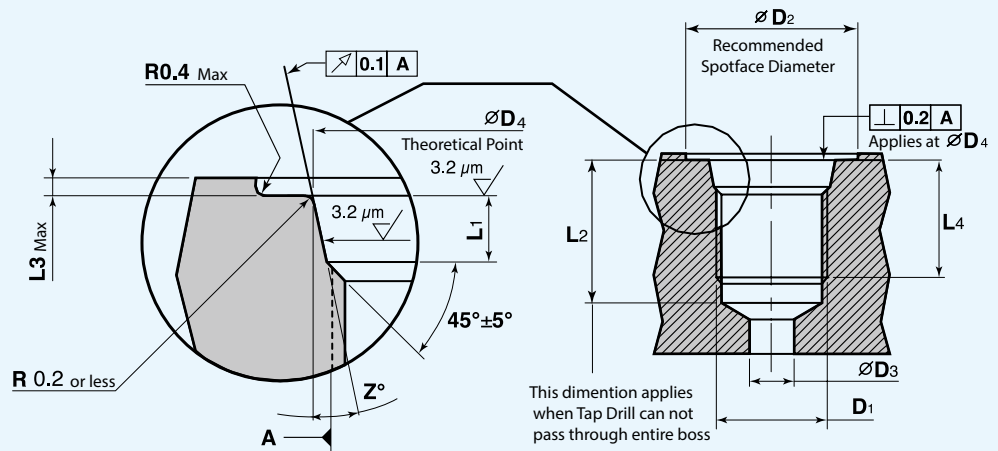

Mounting Dimensions For Oring - Seal Connectors (SAE/MS)

D1 Thread Size	D2 Min. Diameter	D3 Min. Diameter	D4 ± 0.05	L1 ± 0.02	L2 Min.	L3 Max.	L4 Min. Full Thread	Z ± 1°
	mm	mm	mm	mm	mm	mm	mm	°
5/16 - 24 UNF - 2B	17	1.6	9.15	2.1	12	1.6	10	12
3/8 - 24 UNF - 2B	19	3.5	10.75	2.1	12	1.6	10	12
7/16 - 20 UNF - 2B	21	4.5	12.45	2.6	14	1.6	11.5	12
1/2 - 20 UNF - 2B	23	6	14.05	2.6	14	1.6	11.5	12
9/16 - 18 UNF - 2B	25	7.5	15.7	2.7	15.5	1.6	12.7	12
3/4 - 16 UNF - 2B	30	10	20.65	2.7	17.5	2.4	14.3	15
7/8 - 14 UNF - 2B	34	12.5	24	2.7	20	2.4	16.7	15
1 1/16 - 12 UNF - 2B	41	16	29.2	3.5	23	2.4	19	15
1 3/16 - 12 UN - 2B	45	18	32.4	3.5	23	2.4	19	15
1 5/16 - 12 UN - 2B	49	21	35.55	3.5	23	3.2	19	15

Installation Instructions:

Figure 1

Locking backed off

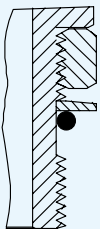

Lubricate the O-ring by inserting it into the groove adjacent to the face of the metal back - up washer which is assembled at the extreme end of the groove as shown in Figure 1.

Figure 2

Fitting install hand tight

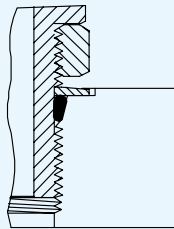

Install the fitting into the S.A.E. straight thread boss, figure 2, until the metal back - up washer contacts the face of the boss as shown in Figure 2.

Figure 3

Fittings backed-off for alignment (1 turn maximum)

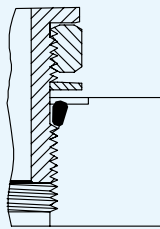

Position the fitting by turning it counter clockwise up to a maximum of one turn (see Figure 3).

Figure 4

Fitting locknut tight to appropriate torque

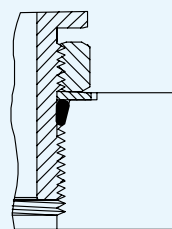

Holding the pad of the fitting with a wrench, tighten the locknut and washer against the face as shown in Figure 4.

"D" - Dimension is minimum hole diameter - dimensions are for reference only, and are subject to change without notice.

Positionables ISO Parallel Thread

Male Elbows

PL

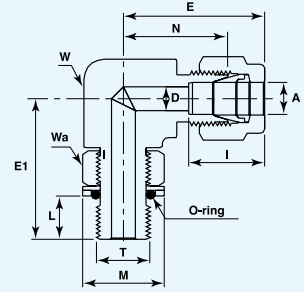

Tube (Inch) To ISO Parallel Thread (Positionable) ※

Part Number	A Tube O.D.		T	D		W		Wa		N		E		E1		L		M		I	O-ring ※※ size I.D.	
	in	mm		in	mm	in	mm	in	mm	in	mm	in	mm	in	mm	in	mm	in	mm			
VUWPL-6.35AF	1/4	6.35	G1/8	0.16	3.9	1/2	12.7	9/16	14.3	0.77	19.6	1.06	26.9	1.04	26.4	0.32	8.1	0.68	17.3	0.6	15.2	8x1.8-G

Tube (Metric) To ISO Parallel Thread (Positionable) ※

Part Numbers	A Tube O.D.		T	D		W		Wa		N		E		E1		L		M		I	O-ring ※※ size I.D.
	mm			mm	in	mm	in	mm	mm	mm	mm	mm	mm	mm	mm	mm	mm				
VUWPL-6AF	6		G1/8	3.9	1/2	12.7	9/16	14.3	19.6	27	26.4	8.1	17.3	15.3							
VUWPL-8AF	8		G1/8	3.9	5/8	15.9	9/16	14.3	21.3	28.8	27.4	8.1	17.3	16.2							8x1.8-G

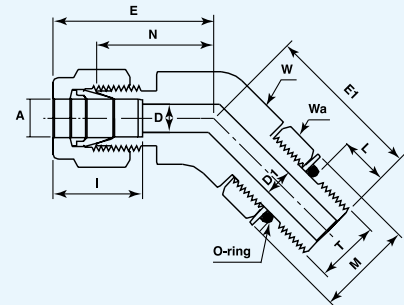

Male Elbows 45°

PL

Tube (Inch) To ISO Parallel Thread (Positionable) ※

Part Number	A Tube O.D.		T	D		D1		W		Wa		N		E		E1		L		M		I	O-ring ※※ size I.D.	
	in	mm		in	mm	in	mm	in	mm	in	mm	in	mm	in	mm	in	mm	in	mm	in	mm			
VUWPL-6.35AF-45	1/4	6.35	G1/8	0.16	4	0.19	4.8	9/16	14.3	9/16	14.3	0.69	17.6	0.98	24.9	0.94	25.3	0.32	8.1	0.68	17.3	0.6	15.2	8x1.8-G

Tube (Metric) To ISO Parallel Thread (Positionable) ※

Part Number	A Tube O.D.		T	D		D1		W		Wa		N		E		E1		L		M		I	O-ring ※※ size I.D.
	mm			mm	in	mm	in	mm	mm	mm	mm	mm	mm	mm	mm	mm	mm	mm	mm				
VUWPL-6AF-45	6		G1/8	4	0.19	4.8	9/16	14.3	9/16	14.3	17.55	25	25.3	8.1	17.3	15.3							8x1.8-G

※ : Per SAE J1926 and MS 16142. See page 81 for mounting dimensions.

※※ : O-rings used are Viton 90 Durometer. Other O-ring materials are available on request.

"D" - Dimension is minimum hole diameter - dimensions are for reference only, and are subject to change without notice.

Positionables ISO Parallel Thread Male Run Tees PTL

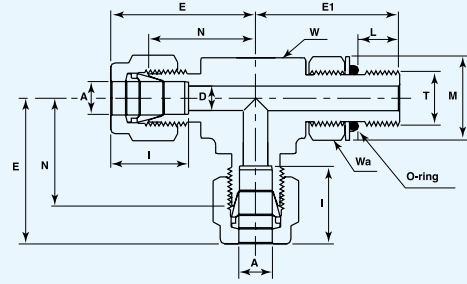

Tube (Inch) To ISO Parallel Thread (Positionable) ※

Part Number	A Tube O.D.		T	D		W		Wa		N		E		E1		L		M		I	O-ring ※※ size I.D.	
	in	mm		in	mm	in	mm	in	mm	in	mm	in	mm	in	mm	in	mm	in	mm			
VUWPTL-6.35AF	1/4	6.35	G1/8	0.16	4	1/2	12.7	9/16	14.3	0.77	19.6	1.06	26.9	1.04	26.4	0.32	8.1	0.68	17.3	0.6	15.2	8x1.8-G

Tube (Metric) To ISO Parallel Thread (Positionable) ※

Part Number	A Tube O.D.		T	D		W		Wa		N		E		E1		L		M		I	O-ring ※※ size I.D.
	mm			mm		in	mm	in	mm	mm		mm		mm		mm		mm		mm	
VUWPTL-6AF	6		G1/8	4		1/2	12.7	9/16	14.3	19.6		27		26.4		8.1		17.3		15.3	8x1.8-G

Male Branch Tees PTS

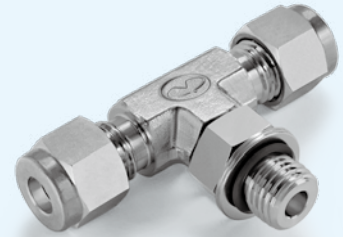
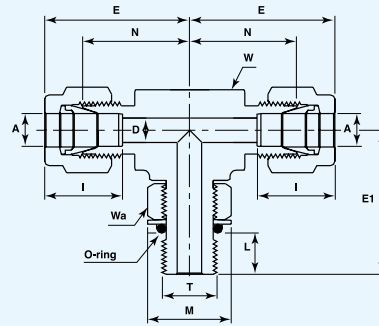

Tube (Inch) To ISO Parallel Thread (Positionable) ※

Part Number	A Tube O.D.		T	D		W		Wa		N		E		E1		L		M		I	O-ring ※※ size I.D.	
	in	mm		in	mm	in	mm	in	mm	in	mm	in	mm	in	mm	in	mm	in	mm			
VUWPTS-6.35AF	1/4	6.35	G1/8	0.16	4	1/2	12.7	9/16	14.3	0.77	19.6	1.06	26.9	1.04	26.4	0.32	8.1	0.68	17.3	0.6	15.2	8x1.8-G

Tube (Metric) To ISO Parallel Thread (Positionable) ※

Part Number	A Tube O.D.		T	D		W		Wa		N		E		E1		L		M		I	O-ring ※※ size I.D.
	mm			mm		in	mm	in	mm	mm		mm		mm		mm		mm		mm	
VUWPTS-6AF	6		G1/8	4		1/2	12.7	9/16	14.3	19.6		27		26.4		8.1		17.3		15.3	8x1.8-G

※ : Per SAE J1926 and MS 16142. See page 81 for mounting dimensions.

※※ : O-rings used are Viton 90 Durometer. Other O-ring materials are available on request.

"D" - Dimension is minimum hole diameter - dimensions are for reference only, and are subject to change without notice.

ISO Parallel Thread (Reference)

Mounting Dimensions Of Connectors				
T	D4		C Min useful Thread	
	in	mm	in	mm
G1/8	0.53	13.5	0.28	7

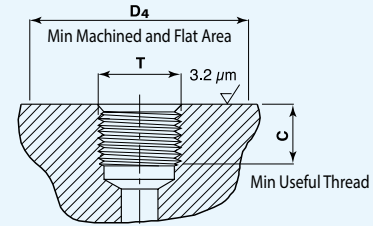

Installation Instructions:

Figure 1
Locking backed off

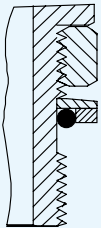

Set the O-ring by inserting it into the groove adjacent to the face of the metal back-up washer which is assembled at the extreme end of the groove as shown in Figure 1.

Figure 2
Fittings install hand tight

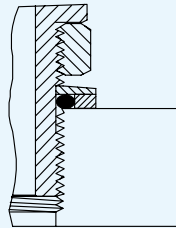

Install the fitting into the ISQ straight thread boss until the metal back-up washer contacts the face of the boss as shown in Figure 2.

Figure 3
Fittings backed-off for O-ring alignment (1 turn maximum)

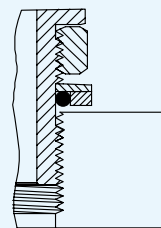

Position the fitting by turning it counter clockwise up to a maximum of one turn. See Figure 3.

Figure 4
Fittings locknut tight to appropriate torque

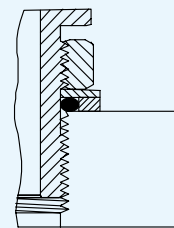

Holding the body of the fitting with a wrench, tighten the locknut and washer against the face as shown in Figure 4.

The contents of the description are reference, and are subject to change without notice.

Stop Collar

V-Lok		D	
in	mm	in	mm
1/4	6.35	0.69	17.5
3/8	9.52	0.84	20.6
1/2	12.7	1.1	27
3/4	19.05	1.31	33.3
1	25.4	1.68	42.7

1. Remove the nut and Rings from the fitting.
2. Insert the stop collar.

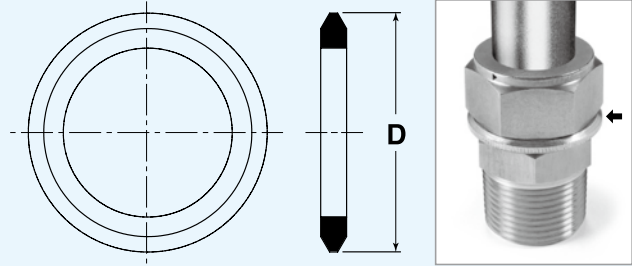

Ordering Information For Assembled Stop Collar (With Fitting)

V U W H

Fitting type
(male V-Lok Fittings)

6.35 BN

Tube O.D.
The O.D. size is always the first
to be described.

SC

Stop Collar

S = Stainless Steel
B = Carbon Zinc Plated

Stop Collar Material

How To Order Stop Collar Only

VUW-6.35 SC

S = Stainless Steel
B = Carbon Zinc Plated

Adapters

When hoping for change in the connection, when you buy the following adapter separately, you're quite able to connect various kinds very easily.

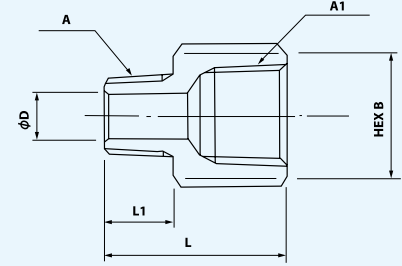

Stainless Steel Pipe Fittings, Adapters

R x Rc Type

Part Numbers	Nominal Dia.	A	A1	B		D		L		L1	
				in	mm	in	mm	in	mm	in	mm
UJB-A x B	R1/8 x Rc1/4	R1/8	Rc1/4	0.75	19	0.18	4.5	1.06	27	0.39	10
UJB-B x A	R1/4 x Rc1/8	R1/4	Rc1/8	0.55	14	0.18	4.5	1.02	26	0.51	13
UJB-B x C	R1/4 x Rc3/8	R1/4	Rc3/8	0.91	23	0.28	7	1.22	31	0.51	13
UJB-C x B	R3/8 x Rc1/4	R3/8	Rc1/4	0.75	19	0.28	7	1.18	30	0.55	14
UJB-C x D	R3/8 x Rc1/2	R3/8	Rc1/2	1.06	27	0.39	10	1.42	36	0.55	14
UJB-D x C	R1/2 x Rc3/8	R1/2	Rc3/8	0.91	23	0.39	10	1.34	34	0.67	17
UJB-D x E	R1/2 x Rc3/4	R1/2	Rc3/4	1.26	32	0.47	12	1.69	43	0.67	17
UJB-E x D	R3/4 x Rc1/2	R3/4	Rc1/2	1.14	29	0.47	12	1.61	41	0.75	19
UJB-E x F	R3/4 x Rc1	R3/4	Rc1	1.61	41	0.63	16	1.93	49	0.75	19
UJB-F x E	R1 x Rc3/4	R1	Rc3/4	1.42	36	0.63	16	1.81	46	0.87	22

R x NPT Type

Part Numbers	Nominal Dia.	A	A1	B		D		L		L1	
				in	mm	in	mm	in	mm	in	mm
UJB-A x AN	R1/8 x 1/8NPT	R1/8	1/8NPT	0.55	14	0.18	4.5	0.91	23	0.39	10
UJB-B x AN	R1/4 x 1/8NPT	R1/4	1/8NPT	0.55	14	0.18	4.5	1.02	26	0.51	13
UJB-B x BN	R1/4 x 1/4NPT	R1/4	1/4NPT	0.75	19	0.28	7	1.14	29	0.51	13
UJB-C x BN	R3/8 x 1/4NPT	R3/8	1/4NPT	0.75	19	0.28	7	1.18	30	0.55	14
UJB-C x CN	R3/8 x 3/8NPT	R3/8	3/8NPT	0.91	23	0.39	10	1.26	32	0.55	14
UJB-D x CN	R1/2 x 3/8NPT	R1/2	3/8NPT	0.91	23	0.39	10	1.34	34	0.67	17
UJB-D x DN	R1/2 x 1/2NPT	R1/2	1/2NPT	1.06	27	0.47	12	1.54	39	0.67	17
UJB-E x DN	R3/4 x 1/2NPT	R3/4	1/2NPT	1.14	29	0.47	12	1.61	41	0.75	19
UJB-E x EN	R3/4 x 3/4NPT	R3/4	3/4NPT	1.26	32	0.63	16	1.77	45	0.75	19
UJB-F x EN	R1 x 3/4NPT	R1	3/4NPT	1.42	36	0.63	16	1.81	46	0.87	22
UJB-F x FN	R1 x 1NPT	R1	1NPT	1.61	41	0.79	20	2.05	52	0.87	22

Stainless Steel Pipe Fittings, Hex Couplings

Rc x Rc (Same Diameter A1=A)

Part Numbers	Nominal Dia.	A	B		D		L	
			in	mm	in	mm	in	mm
UJS-A	Rc1/8	Rc1/8	0.55	14	0.24	6	0.91	23
UJS-B	Rc1/4	Rc1/4	0.75	19	0.31	8	1.18	30
UJS-C	Rc3/8	Rc3/8	0.91	23	0.39	10	1.34	34

Rc x NPT

Part Numbers	Nominal Dia.	A	A1	B		D		L	
				in	mm	in	mm	in	mm
UJS-B x BN	Rc1/4 x 1/4NPT	1/4NPT	Rc1/4	0.75	19	0.31	8	1.18	30
UJS-B x CN	Rc1/4 x 3/8NPT	3/8NPT	Rc1/4	0.91	23	0.31	8	1.26	32
UJS-B x DN	Rc1/4 x 1/2NPT	1/2NPT	Rc1/4	1.06	27	0.31	8	1.42	36

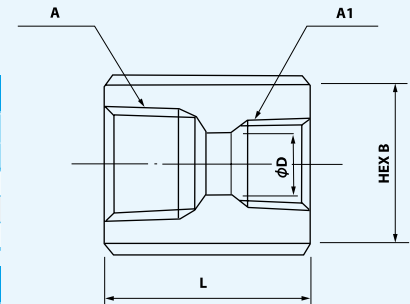

Stainless Steel Pipe Fittings, Nipples

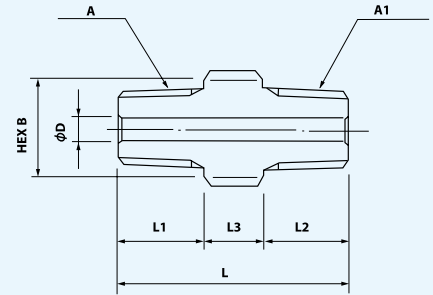

R x R (Same Diameter A1=A, L2=L1)

Part Numbers	Nominal Dia.	d		A, A1	B		L		L1, L2		L3	
		in	mm		in	mm	in	mm	in	mm	in	mm
UJN-A	R1/8	0.157	4	R1/8	0.47	12	0.98	25	0.39	10	0.2	5
UJN-B	R1/4	0.236	6	R1/4	0.55	14	1.22	31	0.51	13	0.2	5
UJN-C	R3/8	0.354	9	R3/8	0.67	17	1.38	35	0.55	14	0.28	7
UJN-D	R1/2	0.472	12	R1/2	0.91	23	1.73	44	0.67	17	0.39	10

R x NPT

Part Numbers	Nominal Dia.	d		A	A1	B		L		L1		L2		L3	
		in	mm			in	mm	in	mm	in	mm	in	mm	in	mm
UJN-A x AN	R1/8 x 1/8NPT	0.157	4	R1/8	1/8NPT	0.98	12	0.98	25	0.39	10	0.39	10	0.2	5
UJN-B x BN	R1/4 x 1/4NPT	0.236	6	R1/4	1/4NPT	0.55	14	1.22	31	0.51	13	0.51	13	0.2	5
UJN-C x CN	R3/8 x 3/8NPT	0.354	9	R3/8	3/8NPT	0.75	19	1.38	35	0.55	14	0.55	14	0.28	7
UJN-D x DN	R1/2 x 1/2NPT	0.472	12	R1/2	1/2NPT	0.91	23	1.73	44	0.67	17	0.67	17	0.39	10

● Use Example

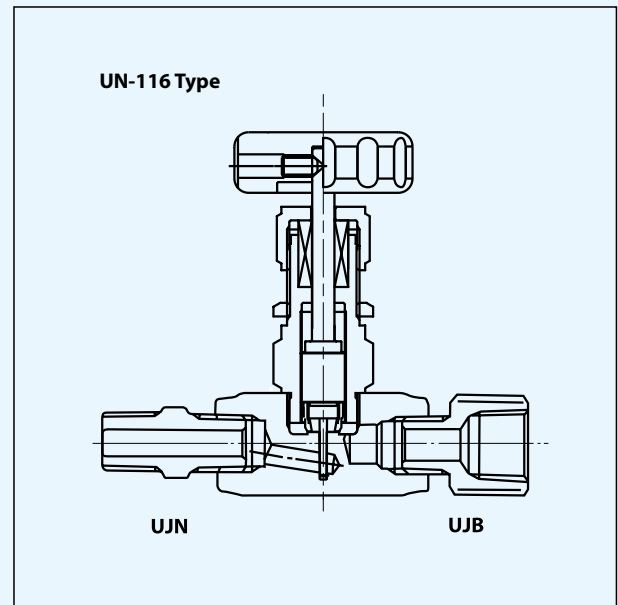

※ : In other ones above-mentioned, some kinds, **Fujikin** has a large selection, so please consult **Fujikin**.

Overview

The **POWERFULOK** is a tube fitting with excellent performance and quality. It is manufactured utilizing the design expertise and production technology that we have accumulated through our many years of experience as a precision fitting manufacturer. The brass **POWERFULOK** is a flareless double Rings compression fitting that does not require tube thread cutting. It consists of a brass (C3771B, C3604B, C3602B) body, front ferrule, back ferrule, and nut.

Reliability

Product performance and reliability are dependent on proper assembly. Before installing the product, please read the Installation Guide on page 103 carefully. Contact Fujikin if you have any questions about assembly procedures.

Features / Applications

- This flareless fitting is easy to install; simply insert the tube into the fitting and tight the nut. No welding is required.
- The Double-Rings connection creates a strong bond. By applying a compressive force to the tube, it achieves extremely high pressure resistance.
- The metal sealing parts, which undergo precision finishing, ensure an airtight seal.
- This compact, lightweight fitting requires low tightening torque, and is easy to disassemble and retighten.
- The tube size is stamped on the body for quick and easy identification.

Pressure and Temperature Ratings

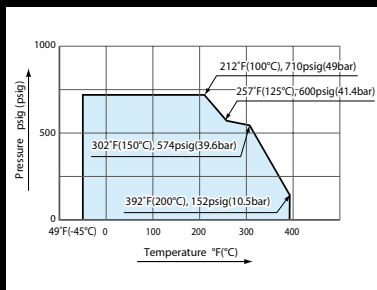

Notes At the maximum operating pressure, the maximum operating temperature is 212 F (100°C) for most fluids. However, air, hot water, and steam have a higher maximum operating temperature 392 F (200°C) . when they are used at lower pressures. Consult with Fujikin before using the POWERFULOK at temperatures greater than 212 F (100°C) .

Applicable Fluid

- Air, Nitrogen gas, Inert gas like Helium, and non-corrosive gas and liquid.

Other

- The front and back Rings are available in metric (mm) and fractional inch sizes. Make sure that you use ferrules of the correct size, or the sealing performance will be compromised.
- Materials and dimensions are subject to change without notice.
- Avoid potential problems by notifying Fujikin before changing the conditions of use.

Parts

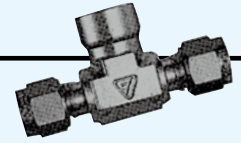
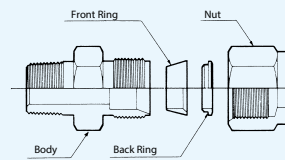

Cross-section after Assembly

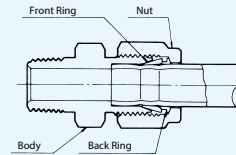

Thread Size

Taper Pipe Thread (JIS)

Designation	A	B	C	D
JIS B0203 (1982)				
Male thread	R1/8	R1/4	R3/8	R1/2
Female thread	Rc1/8	Rc1/4	Rc3/8	Rc1/2

Parallel Pipe Thread (JIS)

Designation	AF	BF	CF	DF
JIS B0203 (1982)	G1/8	G1/4	G3/8	G1/2

National Pipe Taper Thread (ANSI)

Designation	AN	BN	CN	DN
ANSI B2.1	1/8NPT	1/4NPT	3/8NPT	1/2NPT

Nominal Diameter

Size in mm

- 3 = 3mm OD
- 4 = 4mm OD
- 6 = 6mm OD
- 8 = 8mm OD
- 10 = 10mm OD
- 12 = 12mm OD

Size in fractional inches

- 3.2 = 3.2mm (1/8") OD
- 6.35 = 6.35mm (1/4") OD
- 9.52 = 9.52mm (3/8") OD
- 12.7 = 12.7mm (1/2") OD

Identification of sizes in mm and metric equivalents (mm) of fractional inches For easy size identification, fitting diameters (expressed in millimeters) are stamped on the body hex and the nut. In addition, metric fittings have stepped shoulders to distinguish them from fractional fittings.

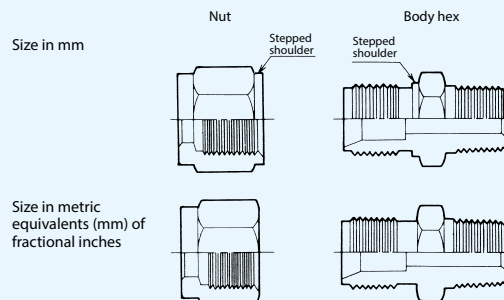

Part Number Designation

P D W H - 6 B - R

Product Series:
POWERFULLOK
Tube Fittings

Material:
Brass

Fitting Type:
Double-Rings
Compression Fitting

Connection Type:
Male Connector















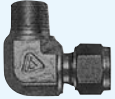

Nominal Diameter:
Outer Diameter of
Tube (mm)

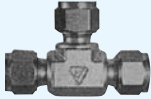
Thread Size:
R 1/4"

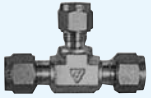
Corresponding
to RoHS

Please use the part number designations below when placing an order or making an inquiry.

Connector Type

H	MALE CONNECTORS	87	GP	BULKHEAD FEMALE CONNECTORS (Rc thread)	93	TL	MALE RUN TEES (R thread)	99
								
HP	BULKHEAD MALE CONNECTORS	88	L	ELBOW UNIONS	94	JC	CAP UNIONS	100
								
F	STRAIGHT UNIONS	89	L	MALE ELBOWS (R thread)	95	JP	PLUG UNIONS	100
								
F	REDUCING UNIONS	89	T	TEE UNIONS	96	S	FRONT RINGS	101
								
P	BULKHEAD UNIONS	90	T	REDUCING TEE UNIONS	96	R	BACK RINGS	101
								
G	FEMALE CONNECTORS (Rc thread)	91	TG	FEMALE BRANCH TEES (Rc thread)	97	N	NUTS	102
								
G	FEMALE CONNECTORS (ISO Parallel Thread)	92	TS	MALE BRANCH TEES (R thread)	98			
								

MALE CONNECTORS

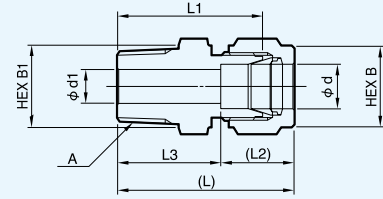

Size in mm

Part numbers	Nominal dia. d	A	d1	B	B1	L	L1	L2	L3
PDWH-3A-R	3	R1/8	2.4	10	12	29.5	23.1	12.7	16.8
PDWH-3B-R	3	R1/4	2.4	10	14	35.4	29	12.7	22.7
PDWH-4A-R	4	R1/8	2.4	12	12	31.1	24.6	13.6	17.5
PDWH-4B-R	4	R1/4	2.4	12	14	36.2	29.7	13.6	22.6
PDWH-6A-R	6	R1/8	4.8	14	14	32.6	25.4	15.2	17.4
PDWH-6B-R	6	R1/4	4.8	14	14	37.4	30.2	15.2	22.2
PDWH-6C-R	6	R3/8	4.8	14	17	38.2	31	15.2	23
PDWH-6D-R	6	R1/2	4.8	14	22	43.8	36.6	15.2	28.6
PDWH-8A-R	8	R1/8	4.8	16	16	34.2	26.7	16.2	18
PDWH-8B-R	8	R1/4	6.4	16	16	38.7	31.2	16.2	22.5
PDWH-8C-R	8	R3/8	6.4	16	17	39.3	31.8	16.2	23.1
PDWH-8D-R	8	R1/2	6.4	16	22	44.8	37.3	16.2	28.6
PDWH-10A-R	10	R1/8	4.8	19	19	36.1	28.7	17	19.1
PDWH-10B-R	10	R1/4	7.9	19	19	40.7	33.3	17	23.7
PDWH-10C-R	10	R3/8	7.9	19	19	40.7	33.3	17	23.7
PDWH-10D-R	10	R1/2	7.9	19	22	45.5	38.1	17	28.5
PDWH-12A-R	12	R1/8	4.8	22	22	38.5	28.7	22.5	16
PDWH-12B-R	12	R1/4	7.1	22	22	43.1	33.3	22.5	20.6
PDWH-12C-R	12	R3/8	9.5	22	22	43.1	33.3	22.5	20.6
PDWH-12D-R	12	R1/2	9.5	22	22	47.9	38.1	22.5	25.4

Also available with NPT (ANSI) threads.

Size in metric equivalents
(mm) of fractional inches

Part numbers	Nominal dia. d	A	d1	B	B1	L	L1	L2	L3
PDWH-3.2A-R	3.2	R1/8	2.3	12	12	30.6	23.9	13	17.6
PDWH-3.2B-R	3.2	R1/4	2.3	12	14	35.7	29	13	22.7
PDWH-6.35A-R	6.35	R1/8	4.8	14	14	32.8	25.4	15.4	17.4
PDWH-6.35B-R	6.35	R1/4	4.8	14	14	37.9	30.5	15.4	22.5
PDWH-6.35C-R	6.35	R3/8	4.8	14	17	38.4	31	15.4	23
PDWH-6.35D-R	6.35	R1/2	4.8	14	22	44.7	37.3	15.4	29.3
PDWH-9.52A-R	9.52	R1/8	4.8	17	17	35.5	27.9	17.2	18.3
PDWH-9.52B-R	9.52	R1/4	7.1	17	17	40.1	32.5	17.2	22.9
PDWH-9.52C-R	9.52	R3/8	7.1	17	17	40.1	32.5	17.2	22.9
PDWH-9.52D-R	9.52	R1/2	7.1	17	22	46.5	38.9	17.2	29.3
PDWH-12.7A-R	12.7	R1/8	4.8	22	22	39	28.7	23	16
PDWH-12.7B-R	12.7	R1/4	7.1	22	22	43.6	33.3	23	20.6
PDWH-12.7C-R	12.7	R3/8	9.7	22	22	43.6	33.3	23	20.6
PDWH-12.7D-R	12.7	R1/2	10.4	22	22	49.2	38.9	23	26.2

Also available with NPT (ANSI) threads.

Individual drawings may be downloaded from the CAD Data Service section of the Fujikin website. http://www.fujikin.co.jp/fujikinhp_e/cad_s/

BULKHEAD MALE CONNECTORS

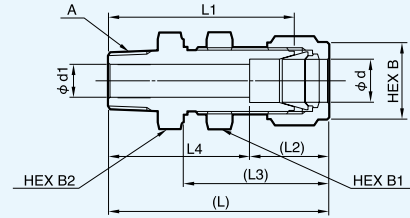
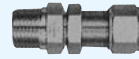

Size in mm

Part numbers	Nominal dia. d	A	Panel hole dia.	d1	B	B1	B2	L	L1	L2	L3	L4
PDWHP-3A-R	3	R1/8	8	2.4	10	14	14	46.3	39.9	12.7	30.7	33.6
PDWHP-3B-R	3	R1/4	8	2.4	10	14	14	51.4	45	12.7	30.7	38.7
PDWHP-6A-R	6	R1/8	11.2	4.8	14	16	16	49.4	42.2	15.2	33.7	34.2
PDWHP-6B-R	6	R1/4	11.2	4.8	14	16	16	53.2	46	15.2	33.7	38
PDWHP-6C-R	6	R3/8	11.2	4.8	14	16	17	54.3	47.1	15.2	33.7	39.1
PDWHP-6D-R	6	R1/2	11.2	4.8	14	16	22	60.6	53.4	15.2	33.7	45.4
PDWHP-8A-R	8	R1/8	12.8	4.8	16	19	19	51.7	44.2	16.2	36.1	35.5
PDWHP-8B-R	8	R1/4	12.8	6.4	16	19	19	56.2	48.7	16.2	36.1	40
PDWHP-8C-R	8	R3/8	12.8	6.4	16	19	19	56.8	49.3	16.2	36.1	40.6
PDWHP-8D-R	8	R1/2	12.8	6.4	16	19	22	62.3	54.8	16.2	36.1	46.1
PDWHP-10A-R	10	R1/8	16	4.8	19	22	22	53.6	46.2	17	36.8	36.6
PDWHP-10B-R	10	R1/4	16	7.1	19	22	22	58.2	50.8	17	36.8	41.2
PDWHP-10C-R	10	R3/8	16	7.9	19	22	22	58.2	50.8	17	36.8	41.2
PDWHP-10D-R	10	R1/2	16	7.9	19	22	22	63	55.6	17	36.8	46
PDWHP-12A-R	12	R1/8	19.1	4.8	22	24	24	58.3	48.5	22.5	41.5	35.8
PDWHP-12B-R	12	R1/4	19.1	7.1	22	24	24	62.9	53.1	22.5	41.5	40.4
PDWHP-12C-R	12	R3/8	19.1	9.5	22	24	24	62.9	53.1	22.5	41.5	40.4
PDWHP-12D-R	12	R1/2	19.1	9.5	22	24	24	68.5	58.7	22.5	41.5	46

Also available with NPT (ANSI) threads.

Size in metric equivalents
(mm) of fractional inches

Part numbers	Nominal dia. d	A	Panel hole dia.	d1	B	B1	B2	L	L1	L2	L3	L4
PDWHP-3.2A-R	3.2	R1/8	8	2.3	12	14	14	46.6	39.9	13	31	33.6
PDWHP-3.2B-R	3.2	R1/4	8	2.3	12	14	14	51.7	45	13	31	38.7
PDWHP-6.35A-R	6.35	R1/8	11.2	4.8	14	16	16	49.6	44.2	15.4	33.9	34.2
PDWHP-6.35B-R	6.35	R1/4	11.2	4.8	14	16	16	53.4	46	15.4	33.9	38
PDWHP-6.35C-R	6.35	R3/8	11.2	4.8	14	16	17	54.5	47.1	15.4	33.9	39.1
PDWHP-6.35D-R	6.35	R1/2	11.2	4.8	14	16	22	60.8	53.4	15.4	33.9	45.4
PDWHP-9.52A-R	9.52	R1/8	14.3	4.8	17	22	22	53.1	45.5	17.2	37.1	35.9
PDWHP-9.52B-R	9.52	R1/4	14.3	7.1	17	22	22	57.6	50	17.2	37.1	40.4
PDWHP-9.52C-R	9.52	R3/8	14.3	7.1	17	22	22	57.6	50	17.2	37.1	40.4
PDWHP-9.52D-R	9.52	R1/2	14.3	7.1	17	22	22	64.1	56.5	17.2	37.1	46.9
PDWHP-12.7A-R	12.7	R1/8	19.1	4.8	22	24	24	58.8	48.5	23	42	35.8
PDWHP-12.7B-R	12.7	R1/4	19.1	7.1	22	24	24	63.4	53.1	23	42	40.4
PDWHP-12.7C-R	12.7	R3/8	19.1	9.4	22	24	24	63.4	53.1	23	42	40.4
PDWHP-12.7D-R	12.7	R1/2	19.1	10.4	22	24	24	69	58.7	23	42	46

Also available with NPT (ANSI) threads.

STRAIGHT UNIONS

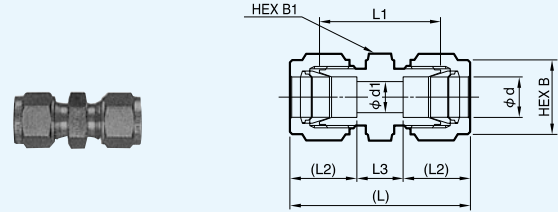

Size in mm

Part numbers	Nominal dia. d	d1	B	B1	L	L1	L2	L3
PDWF-3-R	3	2.4	10	12	34.9	22.1	12.7	9.5
PDWF-4-R	4	2.4	12	12	37.1	24.1	13.6	9.9
PDWF-6-R	6	4.8	14	14	40.6	26.2	15.2	10.2
PDWF-8-R	8	6.4	16	16	43.1	28.2	16.2	10.7
PDWF-10-R	10	7.9	19	19	45.8	31	17	11.8
PDWF-12-R	12	9.5	22	22	50.6	31	22.5	5.6

Size in metric equivalents (mm) of fractional inches

Part numbers	Nominal dia. d	d1	B	B1	L	L1	L2	L3
PDWF-3.2-R	3.2	2.3	12	12	35.7	22.4	13	9.7
PDWF-6.35-R	6.35	4.8	14	14	40.9	26.2	15.4	10.1
PDWF-9.52-R	9.52	7.1	17	17	45.4	30.2	17.2	11
PDWF-12.7-R	12.7	10.4	22	22	51.5	31	23	5.5

REDUCING UNIONS

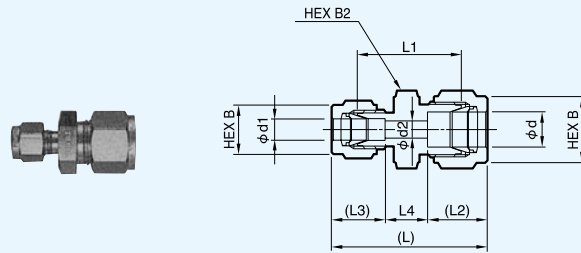

Size in mm

Part numbers	Nominal dia. d	Nominal dia. d1	d2	B	B1	B2	L	L1	L2	L3	L4
PDWF-4x3-R	4	3	2.4	12	10	12	36.5	23.6	13.6	12.7	10.2
PDWF-6x3-R	6	3	2.4	14	10	14	38.2	24.6	15.2	12.7	10.3
PDWF-6x4-R	6	4	2.4	14	12	14	39.1	25.4	15.2	13.6	10.3
PDWF-8x6-R	8	6	4.8	16	14	16	42.1	27.4	16.2	15.2	10.7
PDWF-10x6-R	10	6	4.8	19	14	19	44.1	29.5	17	15.2	11.9
PDWF-10x8-R	10	8	6.4	19	16	19	44.9	30	17	16.2	11.7
PDWF-12x6-R	12	6	4.8	22	14	22	46.5	29.5	22.5	15.2	8.8
PDWF-12x8-R	12	8	6.4	22	16	22	47.5	30.2	22.5	16.2	8.8
PDWF-12x10-R	12	10	7.9	22	19	22	48.2	31	22.5	17	8.7

Size in metric equivalents (mm) of fractional inches

Part numbers	Nominal dia. d	Nominal dia. d1	d2	B	B1	B2	L	L1	L2	L3	L4
PDWF-6.35x3.2-R	6.35	3.2	2.3	14	12	14	38.7	24.6	15.4	13	10.3
PDWF-9.52x6.35-R	9.52	6.35	4.8	17	14	17	43.4	28.4	17.2	15.4	10.8
PDWF-12.7x6.35-R	12.7	6.35	4.8	22	14	22	47.2	29.5	23	15.4	8.8
PDWF-12.7x9.52-R	12.7	9.52	7.1	22	17	22	48.9	31	23	17.2	8.7

Individual drawings may be downloaded from the CAD Data Service section of the Fujikin website. http://www.fujikin.co.jp/fujikinhp_e/cad_s/

BULKHEAD UNIONS

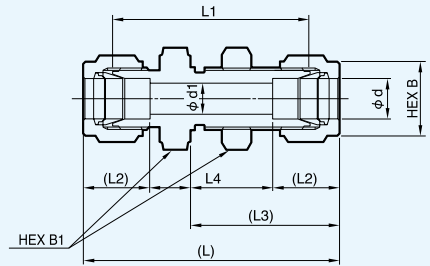

Size in mm

Part numbers	Nominal dia. d	Panel hole dia.	d1	B	B1	L	L1	L2	L3	L4
PDWP-3-R	3	8	2.4	10	14	50.9	38.1	12.7	30.7	25.5
PDWP-4-R	4	9.6	2.4	12	14	53.4	40.4	13.6	31.9	26.2
PDWP-6-R	6	11.2	4.8	14	16	57.3	42.9	15.2	33.7	26.9
PDWP-8-R	8	12.8	6.4	16	19	60.9	46	16.2	36.1	28.5
PDWP-10-R	10	16	7.9	19	22	63.3	48.5	17	36.8	29.3
PDWP-12-R	12	19.1	9.5	22	24	70.4	50.8	22.5	41.5	25.4

Size in metric equivalents
(mm) of fractional inches

Part numbers	Nominal dia. d	Panel hole dia.	d1	B	B1	L	L1	L2	L3	L4
PDWP-3.2-R	3.2	8	2.3	12	14	51.4	38.1	13	31	25.4
PDWP-6.35-R	6.35	11.2	4.8	14	16	57.6	42.9	15.4	33.9	26.8
PDWP-9.52-R	9.52	14.3	7.1	17	22	62.7	47.5	17.2	37.1	28.3
PDWP-12.7-R	12.7	19.1	10.4	22	24	71.3	50.8	23	42	25.3

FEMALE CONNECTORS

Rc Thread

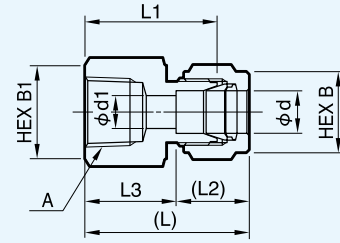
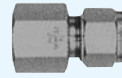

Size in mm

Part numbers	Nominal dia. d	A	d1	B	B1	L	L1	L2	L3
PDWG-3A-R	3	Rc1/8	2.4	10	14	28.5	22.1	12.7	15.8
PDWG-3B-R	3	Rc1/4	2.4	10	19	33.3	26.9	12.7	20.6
PDWG-4A-R	4	Rc1/8	2.4	12	14	29.6	23.1	13.6	16
PDWG-4B-R	4	Rc1/4	2.4	12	19	34.2	27.7	13.6	20.6
PDWG-6A-R	6	Rc1/8	4.8	14	14	31.1	23.9	15.2	15.9
PDWG-6B-R	6	Rc1/4	4.8	14	19	35.6	28.4	15.2	20.4
PDWG-6C-R	6	Rc3/8	4.8	14	22	36.7	29.5	15.2	21.5
PDWG-6D-R	6	Rc1/2	4.8	14	26	42.3	35.1	15.2	27.1
PDWG-8A-R	8	Rc1/8	6.4	16	16	32.1	24.6	16.2	15.9
PDWG-8B-R	8	Rc1/4	6.4	16	19	37	29.5	16.2	20.8
PDWG-8C-R	8	Rc3/8	6.4	16	22	37.7	30.2	16.2	21.5
PDWG-8D-R	8	Rc1/2	6.4	16	26	43.3	35.8	16.2	27.1
PDWG-10A-R	10	Rc1/8	7.9	19	19	32.8	25.4	17	15.8
PDWG-10B-R	10	Rc1/4	7.9	19	19	37.6	30.2	17	20.6
PDWG-10C-R	10	Rc3/8	7.9	19	22	38.4	31	17	21.4
PDWG-10D-R	10	Rc1/2	7.9	19	26	44	36.6	17	27
PDWG-12A-R	12	Rc1/8	8.3	22	22	38.2	28.4	22.5	15.7
PDWG-12B-R	12	Rc1/4	9.5	22	22	40	30.2	22.5	17.5
PDWG-12C-R	12	Rc3/8	9.5	22	22	40.8	31	22.5	18.3
PDWG-12D-R	12	Rc1/2	9.5	22	26	46.4	36.6	22.5	23.9

Also available with NPT (ANSI) threads.

Size in metric equivalents
(mm) of fractional inches

Part numbers	Nominal dia. d	A	d1	B	B1	L	L1	L2	L3
PDWG-3.2A-R	3.2	Rc1/8	2.3	12	14	28.8	22.1	13	15.8
PDWG-3.2B-R	3.2	Rc1/4	2.3	12	19	33.6	26.9	13	20.6
PDWG-6.35A-R	6.35	Rc1/8	4.8	14	14	31.3	23.9	15.4	15.9
PDWG-6.35B-R	6.35	Rc1/4	4.8	14	19	35.8	28.4	15.4	20.4
PDWG-6.35C-R	6.35	Rc3/8	4.8	14	22	37.6	30.2	15.4	22.2
PDWG-6.35D-R	6.35	Rc1/2	4.8	14	26	42.5	35.1	15.4	27.1
PDWG-9.52A-R	9.52	Rc1/8	7.1	17	16	33	25.4	17.2	15.8
PDWG-9.52B-R	9.52	Rc1/4	7.1	17	19	37.8	30.2	17.2	20.6
PDWG-9.52C-R	9.52	Rc3/8	7.1	17	22	39.4	31.8	17.2	22.2
PDWG-9.52D-R	9.52	Rc1/2	7.1	17	26	44.2	36.6	17.2	27
PDWG-12.7A-R	12.7	Rc1/8	7	22	22	38.7	28.4	23	15.7
PDWG-12.7B-R	12.7	Rc1/4	10.4	22	22	40.5	30.2	23	17.5
PDWG-12.7C-R	12.7	Rc3/8	10.4	22	22	42.1	31.8	23	19.1
PDWG-12.7D-R	12.7	Rc1/2	10.4	22	26	46.9	36.6	23	23.9

Also available with NPT (ANSI) threads.

Individual drawings may be downloaded from the CAD Data Service section of the Fujikin website. http://www.fujikin.co.jp/fujikinhp_e/cad_s/

FEMALE CONNECTORS

ISO Parallel Thread

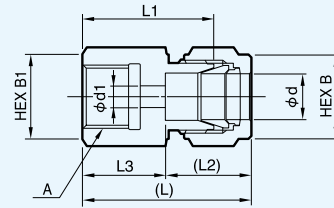
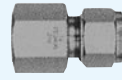

Size in mm

Part numbers	Nominal dia. d	A	d1	B	B1	L	L1	L2	L3
PDWG-3AF-R	3	G1/8	5.5 ※	10	14	32.1	25.7	12.7	19.4
PDWG-3BF-R	3	G1/4	5.5 ※	10	19	35.1	28.7	12.7	22.4
PDWG-4AF-R	4	G1/8	5.5 ※	12	14	33.2	26.7	13.6	19.6
PDWG-4BF-R	4	G1/4	5.5 ※	12	19	36.2	29.7	13.6	22.6
PDWG-6AF-R	6	G1/8	5.5 ※	14	14	34.4	27.2	15.2	19.2
PDWG-6BF-R	6	G1/4	5.5 ※	14	19	37.4	30.2	15.2	22.2
PDWG-6CF-R	6	G3/8	5.5 ※	14	22	37.4	30.2	15.2	22.2
PDWG-6DF-R	6	G1/2	5.5 ※	14	26	42.8	35.6	15.2	27.6
PDWG-8AF-R	8	G1/8	5.5	16	16	35.5	28	16.2	19.3
PDWG-8BF-R	8	G1/4	5.5	16	19	38.5	31	16.2	22.3
PDWG-8CF-R	8	G3/8	5.5	16	22	36.2	28.7	16.2	20
PDWG-8DF-R	8	G1/2	5.5	16	26	40.5	33	16.2	24.3
PDWG-10AF-R	10	G1/8	5.5	19	19	36.2	28.8	17	19.2
PDWG-10BF-R	10	G1/4	5.5	19	19	39.2	31.8	17	22.2
PDWG-10CF-R	10	G3/8	5.5	19	22	38.6	31.2	17	21.6
PDWG-10DF-R	10	G1/2	5.5	19	26	41.2	33.8	17	24.2
PDWG-12AF-R	12	G1/8	5.5	22	22	38.6	28.8	22.5	16.1
PDWG-12BF-R	12	G1/4	5.5	22	22	41.6	31.8	22.5	19.1
PDWG-12CF-R	12	G3/8	5.5	22	22	44.1	34.3	22.5	21.6
PDWG-12DF-R	12	G1/2	5.5	22	26	47.9	38.1	22.5	25.4 ※

Size in metric equivalents (mm) of fractional inches

Part numbers	Nominal dia. d	A	d1	B	B1	L	L1	L2	L3
PDWG-3.2AF-R	3.2	G1/8	5.5 ※	12	14	32.4	25.7	13	19.4
PDWG-3.2BF-R	3.2	G1/4	5.5 ※	12	19	35.4	28.7	13	22.4
PDWG-6.35AF-R	6.35	G1/8	5.5	14	14	34.6	27.2	15.4	19.2
PDWG-6.35BF-R	6.35	G1/4	5.5	14	19	37.6	30.2	15.4	22.2
PDWG-6.35CF-R	6.35	G3/8	5.5	14	22	37.6	30.2	15.4	22.2
PDWG-6.35DF-R	6.35	G1/2	5.5	14	26	43	35.6	15.4	27.6
PDWG-9.52AF-R	9.52	G1/8	5.5	17	16	36.4	28.8	17.2	19.2
PDWG-9.52BF-R	9.52	G1/4	5.5	17	19	39.4	31.8	17.2	22.2
PDWG-9.52CF-R	9.52	G3/8	5.5	17	22	38.8	31.2	17.2	21.6
PDWG-9.52DF-R	9.52	G1/2	5.5	17	26	41.4	33.8	17.2	24.2
PDWG-12.7AF-R	12.7	G1/8	5.5	22	22	39.1	28.8	23	16.1
PDWG-12.7BF-R	12.7	G1/4	5.5	22	22	42.1	31.8	23	19.1
PDWG-12.7CF-R	12.7	G3/8	5.5	22	22	44.6	34.3	23	21.6
PDWG-12.7DF-R	12.7	G1/2	5.5	22	26	48.4	38.1	23	25.4

For fittings with a nominal diameter of 3mm, 3.2mm (1/8"), 4mm, and 6mm, the inner diameter of the gasket ($\phi D1$) is 5.5mm. However, the interior of the fitting's body is stepped such that the portion directly behind the gasket and in front of the tube is as follows : Tube OD (mm): 3.4, 3.2, 6 Fitting ID (mm): 2.4, 2.3, 4.8

BULKHEAD FEMALE CONNECTORS

Rc Thread

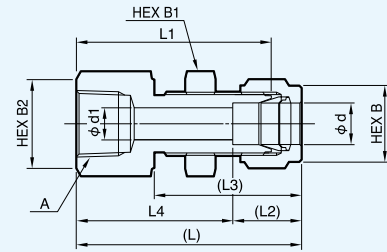
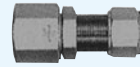

Panel Hole Dia : +0.0315 in. (+0.5mm),
+0

Size in mm

Part numbers	Nominal dia. d	A	Panel hole dia.	d1	B	B1	B2	L	L1	L2	L3	L4
PDWGP-3A-R	3	Rc1/8	8	2.4	10	14	14	44.2	37.8	12.7	30.7	31.5
PDWGP-3B-R	3	Rc1/4	8	2.4	10	14	19	49	42.6	12.7	30.7	36.3
PDWGP-4A-R	4	Rc1/8	9.6	2.4	12	14	14	45.4	38.9	13.6	31.9	31.8
PDWGP-4B-R	4	Rc1/4	9.6	2.4	12	14	19	50	43.5	13.6	31.9	36.4
PDWGP-6A-R	6	Rc1/8	11.2	4.8	14	16	14	47.2	40	15.2	33.7	32
PDWGP-6B-R	6	Rc1/4	11.2	4.8	14	16	19	51.7	44.5	15.2	33.7	36.5
PDWGP-6C-R	6	Rc3/8	11.2	4.8	14	16	22	52.8	45.6	15.2	33.7	37.6
PDWGP-6D-R	6	Rc1/2	11.2	4.8	14	16	26	58.4	51.2	15.2	33.7	43.2
PDWGP-8A-R	8	Rc1/8	12.8	6.4	16	19	16	49.6	42.1	16.2	36.1	33.4
PDWGP-8B-R	8	Rc1/4	12.8	6.4	16	19	19	54.5	47	16.2	36.1	38.3
PDWGP-8C-R	8	Rc3/8	12.8	6.4	16	19	22	55.2	47.7	16.2	36.1	39
PDWGP-8D-R	8	Rc1/2	12.8	6.4	16	19	26	60.8	53.5	16.2	36.1	44.6
PDWGP-10A-R	10	Rc1/8	16	7.9	19	22	19	50.3	42.9	17	36.8	33.3
PDWGP-10B-R	10	Rc1/4	16	7.9	19	22	19	55.1	47.7	17	36.8	38.1
PDWGP-10C-R	10	Rc3/8	16	7.9	19	22	22	55.9	48.5	17	36.8	38.9
PDWGP-10D-R	10	Rc1/2	16	7.9	19	22	26	61.5	54.1	17	36.8	44.5
PDWGP-12A-R	12	Rc1/8	19.1	8.3	22	24	22	58	48.2	22.5	41.5	35.5
PDWGP-12B-R	12	Rc1/4	19.1	9.5	22	24	22	59.8	50	22.5	41.5	37.3
PDWGP-12C-R	12	Rc3/8	19.1	9.5	22	24	22	60.6	50.8	22.5	41.5	38.1
PDWGP-12D-R	12	Rc1/2	19.1	9.5	22	24	26	66.2	56.4	22.5	41.5	43.7

Also available with NPT (ANSI) threads.

Size in metric equivalents
(mm) of fractional inches

Part numbers	Nominal dia. d	A	Panel hole dia.	d1	B	B1	B2	L	L1	L2	L3	L4
PDWGP-3.2A-R	3.2	Rc1/8	8	2.3	12	14	14	44.5	37.8	13	31	31.5
PDWGP-3.2B-R	3.2	Rc1/4	8	2.3	12	14	19	49.3	42.6	13	31	36.3
PDWGP-6.35A-R	6.35	Rc1/8	11.2	4.8	14	16	14	47.4	40	15.4	33.9	32
PDWGP-6.35B-R	6.35	Rc1/4	11.2	4.8	14	16	19	51.9	44.5	15.4	33.9	36.5
PDWGP-6.35C-R	6.35	Rc3/8	11.2	4.8	14	16	22	53.7	46.3	15.4	33.9	38.3
PDWGP-6.35D-R	6.35	Rc1/2	11.2	4.8	14	16	26	58.6	51.2	15.4	33.9	43.2
PDWGP-9.52A-R	9.52	Rc1/8	14.3	7.1	17	22	16	50.6	43	17.2	37.1	33.4
PDWGP-9.52B-R	9.52	Rc1/4	14.3	7.1	17	22	19	55.4	47.8	17.2	37.1	38.2
PDWGP-9.52C-R	9.52	Rc3/8	14.3	7.1	17	22	22	57	49.4	17.2	37.1	39.8
PDWGP-9.52D-R	9.52	Rc1/2	14.3	7.1	17	22	26	61.8	54.2	17.2	37.1	44.6
PDWGP-12.7A-R	12.7	Rc1/8	19.1	8.8	22	24	22	58.5	48.2	23	42	35.5
PDWGP-12.7B-R	12.7	Rc1/4	19.1	10.4	22	24	22	60.3	50	23	42	37.3
PDWGP-12.7C-R	12.7	Rc3/8	19.1	10.4	22	24	22	61.9	51.6	23	42	38.9
PDWGP-12.7D-R	12.7	Rc1/2	19.1	10.4	22	24	26	66.7	56.4	23	42	43.7

Also available with NPT (ANSI) threads.

Individual drawings may be downloaded from the CAD Data Service section of the Fujikin website. http://www.fujikin.co.jp/fujikinhp_e/cad_s/

ELBOW UNIONS

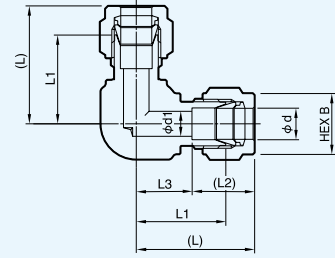
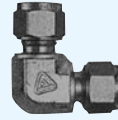

Size in mm

Part numbers	Nominal dia. d	d1	B	L	L1	L2	L3
PDWL-3-R	3	2.4	10	22.1	15.7	12.7	9.4
PDWL-4-R	4	2.4	12	25.3	18.8	13.6	11.7
PDWL-6-R	6	4.8	14	26.8	19.6	15.2	11.6
PDWL-8-R	8	6.4	16	28.8	21.3	16.2	12.6
PDWL-10-R	10	7.9	19	33.3	25.9	17	16.3
PDWL-12-R	12	9.5	22	35.7	25.9	22.5	13.2

Size in metric equivalents
(mm) of fractional inches

Part numbers	Nominal dia. d	d1	B	L	L1	L2	L3
PDWL-3.2-R	3.2	2.3	12	22.4	15.7	13	9.4
PDWL-6.35-R	6.35	4.8	14	27	19.6	15.4	11.6
PDWL-9.52-R	9.52	7.1	17	30.7	23.1	17.2	13.5
PDWL-12.7-R	12.7	10.4	22	36.2	25.9	23	13.2

MALE ELBOWS

R Thread

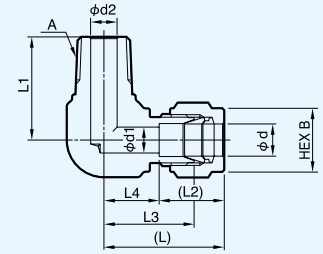
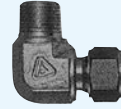

Size in mm

Part numbers	Nominal dia. d	A	d1	B	L	L1	L2	L3	L4
PDWL-3A-R	3	R1/8	2.4	10	23.4	17.8	12.7	17	10.7
PDWL-3B-R	3	R1/4	2.4	10	24.4	23.4	12.7	18	11.7
PDWL-4A-R	4	R1/8	2.4	12	25.3	18.8	13.6	18.8	11.7
PDWL-4B-R	4	R1/4	2.4	12	25.3	23.4	13.6	18.8	11.7
PDWL-6A-R	6	R1/8	4.8	14	26.8	18.8	15.2	19.6	11.6
PDWL-6B-R	6	R1/4	4.8	14	26.8	23.4	15.2	19.6	11.6
PDWL-6C-R	6	R3/8	4.8	14	29.6	26.2	15.2	22.4	14.4
PDWL-6D-R	6	R1/2	4.8	14	31.6	33	15.2	24.4	16.4
PDWL-8A-R	8	R1/8	4.8	16	28.8	19.8	16.2	21.3	12.6
PDWL-8B-R	8	R1/4	6.4	16	28.8	24.4	16.2	21.3	12.6
PDWL-8C-R	8	R3/8	6.4	16	30.6	26.2	16.2	23.1	14.4
PDWL-8D-R	8	R1/2	6.4	16	32.6	33	16.2	25.1	16.4
PDWL-10A-R	10	R1/8	4.8	19	33.3	23.6	17	25.9	16.3
PDWL-10B-R	10	R1/4	7.1	19	33.3	28.2	17	25.9	16.3
PDWL-10C-R	10	R3/8	7.9	19	33.3	28.2	17	25.9	16.3
PDWL-10D-R	10	R1/2	7.9	19	33.3	33	17	25.9	16.3
PDWL-12A-R	12	R1/8	4.8	22	35.7	23.6	22.5	25.9	13.2
PDWL-12B-R	12	R1/4	7.1	22	35.7	28.2	22.5	25.9	13.2
PDWL-12C-R	12	R3/8	9.5	22	35.7	28.2	22.5	25.9	13.2
PDWL-12D-R	12	R1/2	9.5	22	35.7	33	22.5	25.9	13.2

Also available with NPT (ANSI) threads.

Size in metric equivalents
(mm) of fractional inches

Part numbers	Nominal dia. d	A	d1	B	L	L1	L2	L3	L4
PDWL-3.2A-R	3.2	R1/8	2.3	12	23.7	17.8	13	17	10.7
PDWL-3.2B-R	3.2	R1/4	2.3	12	24.7	23.4	13	18	11.7
PDWL-6.35A-R	6.35	R1/8	4.8	14	27	18.8	15.4	19.6	11.6
PDWL-6.35B-R	6.35	R1/4	4.8	14	27	23.4	15.4	19.6	11.6
PDWL-6.35C-R	6.35	R3/8	4.8	14	29.8	26.2	15.4	22.4	14.4
PDWL-6.35D-R	6.35	R1/2	4.8	14	31.8	33	15.4	24.4	16.4
PDWL-9.52A-R	9.52	R1/8	4.8	17	30.7	20.8	17.2	23.1	13.5
PDWL-9.52B-R	9.52	R1/4	7.1	17	30.7	25.4	17.2	23.1	13.5
PDWL-9.52C-R	9.52	R3/8	7.1	17	31.5	26.2	17.2	23.9	14.3
PDWL-9.52D-R	9.52	R1/2	7.1	17	33.5	33	17.2	25.9	16.3
PDWL-12.7A-R	12.7	R1/8	4.8	22	36.2	23.6	23	25.9	13.2
PDWL-12.7B-R	12.7	R1/4	7.1	22	36.2	28.2	23	25.9	13.2
PDWL-12.7C-R	12.7	R3/8	9.7	22	36.2	28.2	23	25.9	13.2
PDWL-12.7D-R	12.7	R1/2	10.4	22	36.2	33	23	25.9	13.2

Also available with NPT (ANSI) threads.

Individual drawings may be downloaded from the CAD Data Service section of the Fujikin website. http://www.fujikin.co.jp/fujikinhp_e/cad_s/

TEE UNIONS

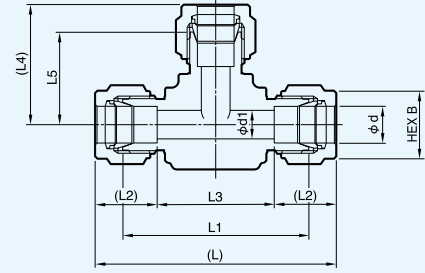
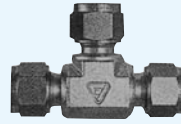

Size in mm

Part numbers	Nominal dia. d	d1	B	L	L1	L2	L3	L4	L5
PDWT-3-R	3	2.4	10	44.2	31.4	12.7	18.8	22.1	15.7
PDWT-4-R	4	2.4	12	50.6	37.6	13.6	23.4	25.3	18.8
PDWT-6-R	6	4.8	14	53.4	39	15.2	23	26.7	19.5
PDWT-8-R	8	6.4	16	59.7	44.8	16.2	27.3	29.9	22.4
PDWT-10-R	10	7.9	19	66.6	51.8	17	32.6	33.3	25.9
PDWT-12-R	12	9.5	22	71.4	51.8	22.5	26.4	35.7	25.9

Size in metric equivalents
(mm) of fractional inches

Part numbers	Nominal dia. d	d1	B	L	L1	L2	L3	L4	L5
PDWT-3.2-R	3.2	2.3	12	44.9	31.6	13	18.9	22.5	15.8
PDWT-6.35-R	6.35	4.8	14	53.7	39	15.4	22.9	26.9	19.5
PDWT-9.52-R	9.52	7.1	17	61.4	46.2	17.2	27	30.7	23.1
PDWT-12.7-R	12.7	10.4	22	72.3	51.8	23	26.3	36.2	25.9

REDUCING TEE UNIONS

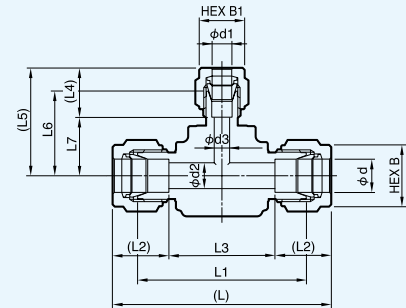
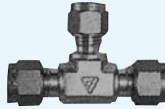

Size in mm

Part numbers	Nominal dia. d	Nominal dia. d1	d2	d3	B	B1	L	L1	L2	L3	L4	L5	L6	L7
PDWT-8x8x6-R	8	6	6.4	4.8	16	14	59.7	44.8	16.2	27.3	15.2	29.6	22.4	14.4
PDWT-10x10x6-R	10	6	7.9	4.8	19	14	66.6	51.8	17	32.6	15.2	33.1	25.9	17.9
PDWT-10x10x8-R	10	8	7.9	6.4	19	16	66.6	51.8	17	32.6	16.2	33.4	25.9	17.2
PDWT-12x12x6-R	12	6	9.5	4.8	22	14	71.4	51.8	22.5	26.4	15.2	33.1	25.9	17.9
PDWT-12x12x8-R	12	8	9.5	6.4	22	16	71.4	51.8	22.5	26.4	16.2	33.4	25.9	17.2
PDWT-12x12x10-R	12	10	9.5	7.9	22	19	71.4	51.8	22.5	26.4	17	33.3	25.9	16.3

Size in metric equivalents
(mm) of fractional inches

Part numbers	Nominal dia. d	Nominal dia. d1	d2	d3	B	B1	L	L1	L2	L3	L4	L5	L6	L7
PDWT-9.52x9.52x6.35-R	9.52	6.35	7.1	4.8	17	14	61.4	46.2	17.2	27	15.4	30.5	23.1	15.1
PDWT-12.7x12.7x6.35-R	12.7	6.35	10.4	4.8	22	14	72.3	51.8	23	26.3	15.4	33.3	25.9	17.9
PDWT-12.7x12.7x9.52-R	12.7	9.52	10.4	7.1	22	17	72.3	51.8	23	26.3	17.2	33.5	25.9	16.3

FEMALE BRANCH TEES

Rc Thread

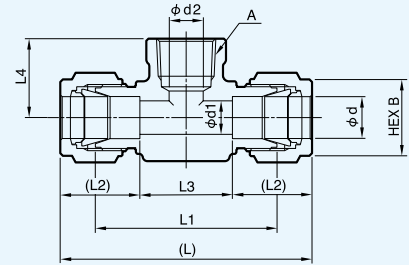
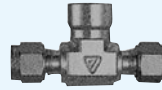

Size in mm

Part numbers	Nominal dia. d	A	d1	d2	B	L	L1	L2	L3	L4
PDWTG-3A-R	3	Rc1/8	2.4	7	10	48.9	36.1	12.7	22.7	19.1
PDWTG-3B-R	3	Rc1/4	2.4	7	10	54.4	41.6	12.7	29	22.4
PDWTG-4A-R	4	Rc1/8	2.4	7	12	50.6	37.6	13.6	23.4	19.1
PDWTG-4B-R	4	Rc1/4	2.4	7	12	54.6	41.6	13.6	27.4	22.4
PDWTG-6A-R	6	Rc1/8	4.8	7	14	53.5	39.1	15.2	22.5	19.1
PDWTG-6B-R	6	Rc1/4	4.8	7	14	59.1	44.7	15.2	28.1	22.4
PDWTG-6C-R	6	Rc3/8	4.8	7	14	63.2	48.8	15.2	32.8	22.4
PDWTG-8A-R	8	Rc1/8	6.4	7	16	57.5	42.6	16.2	25.1	19.1
PDWTG-8B-R	8	Rc1/4	6.4	7	16	61.1	46.2	16.2	28.7	22.4
PDWTG-8C-R	8	Rc3/8	6.4	7	16	63.7	48.8	16.2	31.3	22.4
PDWTG-10A-R	10	Rc1/8	7.9	7	19	66.6	51.8	17	32.6	22.4
PDWTG-10B-R	10	Rc1/4	7.9	7.9	19	66.6	51.8	17	32.6	22.4
PDWTG-10C-R	10	Rc3/8	7.9	7.9	19	66.6	51.8	17	32.6	22.4
PDWTG-12A-R	12	Rc1/8	8.3	7	22	71.4	51.8	22.5	26.4	22.4
PDWTG-12B-R	12	Rc1/4	9.5	9.5	22	71.4	51.8	22.5	26.4	22.4
PDWTG-12C-R	12	Rc3/8	9.5	9.5	22	71.4	51.8	22.5	26.4	22.4

Also available with NPT (ANSI) threads.

Size in metric equivalents (mm) of fractional inches

Part numbers	Nominal dia. d	A	d1	d2	B	L	L1	L2	L3	L4
PDWTG-3.2A-R	3.2	Rc1/8	2.3	7.1	12	49.4	36.1	13	23.4	19.1
PDWTG-3.2B-R	3.2	Rc1/4	2.3	7.1	12	54.9	41.6	13	28.9	22.4
PDWTG-6.35A-R	6.35	Rc1/8	4.8	7.1	14	53.8	39.1	15.4	23	19.1
PDWTG-6.35B-R	6.35	Rc1/4	4.8	7.1	14	59.4	44.7	15.4	28.6	22.4
PDWTG-6.35C-R	6.35	Rc3/8	4.8	7.1	14	63.5	48.8	15.4	32.7	22.4
PDWTG-9.52A-R	9.52	Rc1/8	7.1	7.1	17	61.4	46.2	17.2	27	19.1
PDWTG-9.52B-R	9.52	Rc1/4	7.1	7.1	17	63	47.8	17.2	28.6	22.4
PDWTG-9.52C-R	9.52	Rc3/8	7.1	7.1	17	67	51.8	17.2	32.6	22.4
PDWTG-12.7A-R	12.7	Rc1/8	10.4	7.1	22	72.3	51.8	23	26.3	22.4
PDWTG-12.7B-R	12.7	Rc1/4	10.4	9.5	22	72.3	51.8	23	26.3	22.4
PDWTG-12.7C-R	12.7	Rc3/8	10.4	10.4	22	72.3	51.8	23	26.3	22.4

Also available with NPT (ANSI) threads.

Individual drawings may be downloaded from the CAD Data Service section of the Fujikin website. http://www.fujikin.co.jp/fujikinhp_e/cad_s/

MALE BRANCH TEES

R Thread

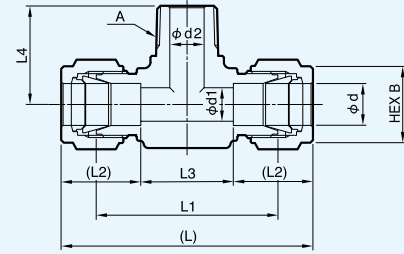
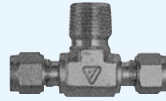

Size in mm

Part numbers	Nominal dia. d	A	d1	d2	B	L	L1	L2	L3	L4
PDWTS-3A-R	3	R1/8	2.4	4.8	10	46.8	34	12.7	21.4	17.8
PDWTS-3B-R	3	R1/4	2.4	4.8	10	48.9	36.1	12.7	23.5	23.4
PDWTS-4A-R	4	R1/8	2.4	4.8	12	48.6	35.6	13.6	21.4	17.8
PDWTS-4B-R	4	R1/4	2.4	4.8	12	48.6	35.6	13.6	21.4	23.4
PDWTS-6A-R	6	R1/8	4.8	4.8	14	53.5	39.1	15.2	23.1	18.8
PDWTS-6B-R	6	R1/4	4.8	4.8	14	53.5	39.1	15.2	23.1	23.4
PDWTS-6C-R	6	R3/8	4.8	4.8	14	59.2	44.8	15.2	28.8	26.2
PDWTS-6D-R	6	R1/2	4.8	4.8	14	63.2	48.8	15.2	32.8	33
PDWTS-8A-R	8	R1/8	6.4	4.8	16	59.6	44.7	16.2	27.2	20.8
PDWTS-8B-R	8	R1/4	6.4	6.4	16	59.6	44.7	16.2	27.2	25.4
PDWTS-8C-R	8	R3/8	6.4	6.4	16	61.1	46.2	16.2	28.7	26.2
PDWTS-8D-R	8	R1/2	6.4	6.4	16	65.1	50.2	16.2	32.7	33
PDWTS-10A-R	10	R1/8	7.9	4.8	19	66.6	51.8	17	32.6	23.6
PDWTS-10B-R	10	R1/4	7.9	7.1	19	66.6	51.8	17	32.6	28.2
PDWTS-10C-R	10	R3/8	7.9	7.9	19	66.6	51.8	17	32.6	28.2
PDWTS-10D-R	10	R1/2	7.9	7.9	19	66.6	51.8	17	32.6	33
PDWTS-12A-R	12	R1/8	9.5	4.8	22	71.4	51.8	22.5	26.4	23.6
PDWTS-12B-R	12	R1/4	9.5	7.1	22	71.4	51.8	22.5	26.4	28.2
PDWTS-12C-R	12	R3/8	9.5	9.5	22	71.4	51.8	22.5	26.4	28.2
PDWTS-12D-R	12	R1/2	9.5	9.5	22	71.4	51.8	22.5	26.4	33

Also available with NPT (ANSI) threads.

Size in metric equivalents
(mm) of fractional inches

Part numbers	Nominal dia. d	A	d1	d2	B	L	L1	L2	L3	L4
PDWTS-3.2A-R	3.2	R1/8	2.3	4.8	12	47.3	34	13	21.3	17.8
PDWTS-3.2B-R	3.2	R1/4	2.3	4.8	12	49.4	36.1	13	23.4	23.4
PDWTS-6.35A-R	6.35	R1/8	4.8	4.8	14	53.8	39.1	15.4	23	18.8
PDWTS-6.35B-R	6.35	R1/4	4.8	4.8	14	53.8	39.1	15.4	23	23.4
PDWTS-6.35C-R	6.35	R3/8	4.8	4.8	14	59.5	44.8	15.4	28.7	26.2
PDWTS-6.35D-R	6.35	R1/2	4.8	4.8	14	63.5	48.8	15.4	32.7	33
PDWTS-9.52A-R	9.52	R1/8	7.1	4.8	17	61.4	46.2	17.2	27	20.8
PDWTS-9.52B-R	9.52	R1/4	7.1	7.1	17	61.4	46.2	17.2	27	25.4
PDWTS-9.52C-R	9.52	R3/8	7.1	7.1	17	67	51.8	17.2	32.6	28.2
PDWTS-9.52D-R	9.52	R1/2	7.1	7.1	17	67	51.8	17.2	32.6	33
PDWTS-12.7A-R	12.7	R1/8	10.4	4.8	22	72.3	51.8	23	26.3	23.6
PDWTS-12.7B-R	12.7	R1/4	10.4	7.1	22	72.3	51.8	23	26.3	28.2
PDWTS-12.7C-R	12.7	R3/8	10.4	9.7	22	72.3	51.8	23	26.3	28.2
PDWTS-12.7D-R	12.7	R1/2	10.4	10.4	22	72.3	51.8	23	26.3	33

Also available with NPT (ANSI) threads.

MALE RUN TEES

R Thread

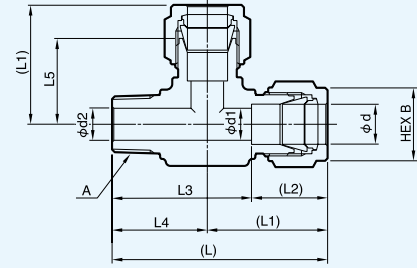
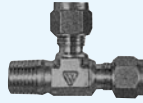

Size in mm

Part numbers	Nominal dia. d	A	d1	d2	B	L	L1	L2	L3	L4	L5
PDWTL-3A-R	3	R1/8	2.4	4.8	10	41.2	23.4	12.7	28.5	17.8	17
PDWTL-3B-R	3	R1/4	2.4	4.8	10	47.8	24.4	12.7	35.1	23.4	18
PDWTL-4A-R	4	R1/8	2.4	4.8	12	42.1	24.3	13.6	28.5	17.8	17.8
PDWTL-4B-R	4	R1/4	2.4	4.8	12	47.7	24.3	13.6	34.1	23.4	17.8
PDWTL-6A-R	6	R1/8	4.8	4.8	14	45.6	26.8	15.2	30.4	18.8	19.6
PDWTL-6B-R	6	R1/4	4.8	4.8	14	50.2	26.8	15.2	35	23.4	19.6
PDWTL-6C-R	6	R3/8	4.8	4.8	14	55.8	29.6	15.2	40.6	26.2	22.4
PDWTL-6D-R	6	R1/2	4.8	4.8	14	64.6	31.6	15.2	49.4	33	24.4
PDWTL-8A-R	8	R1/8	6.4	4.8	16	50.7	29.9	16.2	34.5	20.8	22.4
PDWTL-8B-R	8	R1/4	6.4	6.4	16	55.3	29.9	16.2	39.1	25.4	22.4
PDWTL-8C-R	8	R3/8	6.4	6.4	16	56.8	30.6	16.2	40.6	26.2	23.1
PDWTL-8D-R	8	R1/2	6.4	6.4	16	65.6	32.6	16.2	49.4	33	25.1
PDWTL-10A-R	10	R1/8	7.9	4.8	19	56.9	33.3	17	39.9	23.6	25.9
PDWTL-10B-R	10	R1/4	7.9	7.1	19	61.5	33.3	17	44.5	28.2	25.9
PDWTL-10C-R	10	R3/8	7.9	7.9	19	61.5	33.3	17	44.5	28.2	25.9
PDWTL-10D-R	10	R1/2	7.9	7.9	19	66.3	33.3	17	49.3	33	25.9
PDWTL-12A-R	12	R1/8	9.5	4.8	22	59.3	35.7	22.5	36.8	23.6	25.9
PDWTL-12B-R	12	R1/4	9.5	7.1	22	63.9	35.7	22.5	41.4	28.2	25.9
PDWTL-12C-R	12	R3/8	9.5	9.5	22	63.9	35.7	22.5	41.4	28.2	25.9
PDWTL-12D-R	12	R1/2	9.5	9.5	22	68.7	35.7	22.5	46.2	33	25.9

Also available with NPT (ANSI) threads.

Size in metric equivalents
(mm) of fractional inches

Part numbers	Nominal dia. d	A	d1	d2	B	L	L1	L2	L3	L4	L5
PDWTL-3.2A-R	3.2	R1/8	2.3	4.8	12	41.5	23.7	13	28.5	17.8	17
PDWTL-3.2B-R	3.2	R1/4	2.3	4.8	12	48.1	24.7	13	35.1	23.4	18
PDWTL-6.35A-R	6.35	R1/8	4.8	4.8	14	45.8	27	15.4	30.4	18.8	19.6
PDWTL-6.35B-R	6.35	R1/4	4.8	4.8	14	50.4	27	15.4	35	23.4	19.6
PDWTL-6.35C-R	6.35	R3/8	4.8	4.8	14	56	29.8	15.4	40.6	26.2	22.4
PDWTL-6.35D-R	6.35	R1/2	4.8	4.8	14	64.8	31.8	15.4	49.4	33	24.4
PDWTL-9.52A-R	9.52	R1/8	7.1	4.8	17	51.5	30.7	17.2	34.3	20.8	23.1
PDWTL-9.52B-R	9.52	R1/4	7.1	7.1	17	56.1	30.7	17.2	38.9	25.4	23.1
PDWTL-9.52C-R	9.52	R3/8	7.1	7.1	17	61.7	33.5	17.2	44.5	28.2	25.9
PDWTL-9.52D-R	9.52	R1/2	7.1	7.1	17	66.5	33.5	17.2	49.3	33	25.9
PDWTL-12.7A-R	12.7	R1/8	10.4	4.8	22	59.8	36.2	23	36.8	23.6	25.9
PDWTL-12.7B-R	12.7	R1/4	10.4	7.1	22	64.4	36.2	23	41.4	28.2	25.9
PDWTL-12.7C-R	12.7	R3/8	10.4	9.7	22	64.6	36.4	23	41.6	28.2	25.9
PDWTL-12.7D-R	12.7	R1/2	10.4	10.4	22	69.4	36.4	23	46.4	33	25.9

Also available with NPT (ANSI) threads.

Individual drawings may be downloaded from the CAD Data Service section of the Fujikin website. http://www.fujikin.co.jp/fujikinhp_e/cad_s/

CAP UNIONS

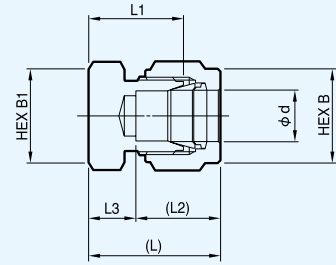

Size in mm

Part numbers	Nominal dia. d	B	B1	L	L1	L2	L3
PDWJC-3-R	3	10	12	19.9	13.5	12.7	7.2
PDWJC-4-R	4	12	12	21.2	14.7	13.6	7.6
PDWJC-6-R	6	14	14	22.9	15.7	15.2	7.7
PDWJC-8-R	8	16	16	24.5	17	16.2	8.3
PDWJC-10-R	10	19	19	26.4	19	17	9.4
PDWJC-12-R	12	22	22	28.8	19	22.5	6.3

Size in metric equivalents
(mm) of fractional inches

Part numbers	Nominal dia. d	B	B1	L	L1	L2	L3
PDWJC-3.2-R	3.2	12	12	20.2	13.5	13	7.2
PDWJC-6.35-R	6.35	14	14	23.4	16	15.4	8
PDWJC-9.52-R	9.52	17	17	25.9	18.3	17.2	8.7
PDWJC-12.7-R	12.7	22	22	29.4	19.1	23	6.4

PLUG UNIONS

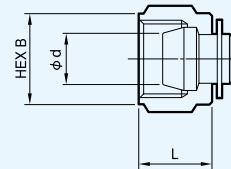

Size in mm

Part numbers	Nominal dia. d	B	L
PDWJP-3-R	3	10	11.8
PDWJP-4-R	4	12	11.9
PDWJP-6-R	6	14	12.6
PDWJP-8-R	8	16	13.4
PDWJP-10-R	10	19	15
PDWJP-12-R	12	22	17.4

Size in metric equivalents
(mm) of fractional inches

Part numbers	Nominal dia. d	B	L
PDWJP-3.2-R	3.2	12	11.8
PDWJP-6.35-R	6.35	14	12.6
PDWJP-9.52-R	9.52	17	14.2
PDWJP-12.7-R	12.7	22	17.4

FRONT Rings



Size in mm

Part numbers	Nominal dia. d	L
PDW-3S-R	3	4.9
PDW-4S-R	4	4.9
PDW-6S-R	6	4.9
PDW-8S-R	8	4.9
PDW-10S-R	10	4.9
PDW-12S-R	12	7.3

Size in metric equivalents
(mm) of fractional inches

Part numbers	Nominal dia. d	L
PDW-3.2S-R	3.2	4.9
PDW-6.35S-R	6.35	4.9
PDW-9.52S-R	9.52	4.9
PDW-12.7S-R	12.7	7.3

BACK Rings



Size in mm

Part numbers	Nominal dia. d	L
PDW-3R-R	3	2.6
PDW-4R-R	4	2.6
PDW-6R-R	6	2.6
PDW-8R-R	8	2.6
PDW-10R-R	10	2.6
PDW-12R-R	12	3.8

Size in metric equivalents
(mm) of fractional inches

Part numbers	Nominal dia. d	L
PDW-3.2R-R	3.2	2.6
PDW-6.35R-R	6.35	2.6
PDW-9.52R-R	9.52	2.6
PDW-12.7R-R	12.7	3.8

Individual drawings may be downloaded from the CAD Data Service section of the Fujikin website. http://www.fujikin.co.jp/fujikinhp_e/cad_s/

NUTS

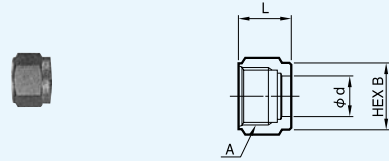

Size in mm

Part numbers	Nominal dia. d	A	B	L
PDW-3N-R	3	5/16-20UN	10	11.8
PDW-4N-R	4	3/8-20UN	12	11.9
PDW-6N-R	6	7/16-20UNF	14	12.6
PDW-8N-R	8	1/2-20UNF	16	13.4
PDW-10N-R	10	5/8-20UN	19	15
PDW-12N-R	12	3/4-20UNEF	22	17.4

Size in metric equivalents
(mm) of fractional inches

Part numbers	Nominal dia. d	A	B	L
PDW-3.2N-R	3.2	5/16-20UN	12	11.8
PDW-6.35N-R	6.35	7/16-20UNF	14	12.6
PDW-9.52N-R	9.52	9/16-20UN	17	14.2
PDW-12.7N-R	12.7	3/4-20UNEF	22	17.4

● Before Installation

- The tubes used must:
 - Be made of soft (O, annealed) or hard (1/2H) copper.
 - Have a tolerance within $\pm 0.1\text{mm}$ of the tube OD.
 - Be free of visible scratches 30mm from either end of the tube.
 - Refer a wall thickness listed in the table below.
 Consult with Fujikin before using non-copper tubes.
- Before assembling the fittings, cut the tubes to the required length. Cutting tubes after fitting assembly will cause bending stress at the fitting seals and may result in leakage.

In case of using "O (annealed)" copper tube

Nominal Dia. mm	Nominal Dia. inches	Nominal Wall Thicknesses of tubes (mm)
3	3.2 ($1/8^{\text{OD}}$)	0.5
4	—	0.8
6	6.35 ($1/4^{\text{OD}}$)	1 ~ 1.5
8, 10	9.52 ($3/8^{\text{OD}}$)	1 ~ 1.5
12	12.7 ($1/2^{\text{OD}}$)	1.2 ~ 1.5
—	19.05 ($3/4^{\text{OD}}$)	1.5 ~ 2

In case of using "1/2 H" copper tube

Nominal Dia. mm	Nominal Dia. inches	Nominal Wall Thicknesses of tubes (mm)
6	6.35 ($1/4^{\text{OD}}$)	0.8
8, 10	9.52 ($3/8^{\text{OD}}$)	0.8
12	12.7 ($1/2^{\text{OD}}$)	1.2

- Use a tube cutter to cut the tubes to the required length. If it is necessary to use a different method, be sure to cut the tubes at a right angle, and then remove burrs carefully from the outer circumference by filing at a 45° angle to the centerline. Use a scraper or a round file to remove burrs inside the tubes. Ensure that no burrs remain.
- When installing fittings near tube bends, there must be a sufficient straight length of tubing to allow for proper installation (see the table to the left; units in millimeters).

D (mm)	L (mm)		R (mm)
	L1	L2	
6, 6.35	21	14.3	
8	22	18	17.5
10, 9.52	24	19.5	23.8
12, 12.7	31	26	38.1

L1: Recommended straight tube length.
L2: Minimum straight tube length.

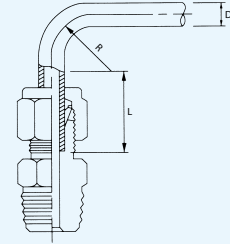

● Assembly

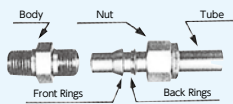

Ensure that the parts are installed in the order shown in the picture (left). Assembling them in the wrong order may result in leakage.

Insert the tube completely until it makes contact with the body. Hand-tighten the nut until it cannot be tightened further. After manually tightening the nut, mark both the body and the nut. This point is the zero point.

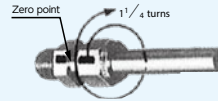

With a wrench, tighten the nut $1/4$ turns from the zero point. Assembly is then complete.

Exceptions:

- Fittings with nominal diameters of 4mm, 3.2mm ($1/8^{\text{OD}}$) or smaller: Tighten the nut a $3/4$ turn.
- Plug unions (product number: PDWJP): Tighten the nut a $1/4$ turn, regardless of size.

● Reassembly

- Hand-tighten the nut until it cannot be tightened further. Then use a wrench to tighten it another $1/8$ turn.
- Note: After reassembly, the body and the nut should return to their original position, or be tightened slightly further.

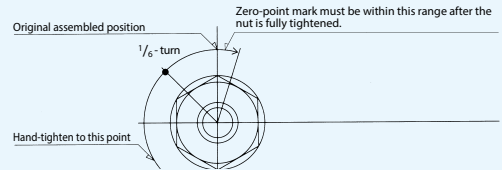

● Preswaging

- In situations where it may be difficult to tighten the ferrules (e.g., in installation locations where a wrench cannot be used), the fittings may not be assembled correctly. In such situations, attach the front ferrule, back ferrule, and nut to the tube beforehand.
- Hand-tighten the nut until it cannot be tightened further (zero point). With a wrench, further tighten the nut 1 turn. Next, loosen the nut until it can be manually turned. At the fitting's actual installation location, use a wrench to tighten the nut another $1/2$ turn from the zero point. Assembly is then complete.

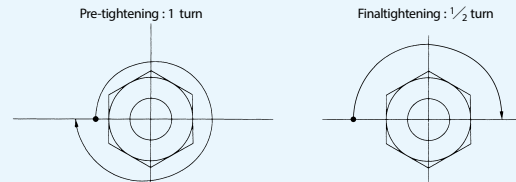

● Preparations: Before Operation

- For tightening, use the appropriate wrench.
- Before tightening the fitting, ensure that its body has been secured using a wrench. Never hold the nut in place while attempting to tighten the body.

a. Assembling Male Connectors

Use a wrench to secure the body.

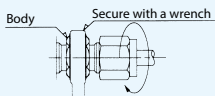

b. Assembling Straight Unions

Secure the body and tighten either the left nut or the right nut. Then tighten the other nut. Do not attempt to tighten one nut while holding onto the other.

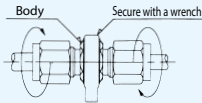

c. Assembling Tee Unions

Secure the body. Always start tightening from Position 1. Preswaging the nut and ferrules at Position 1 facilitates installation.

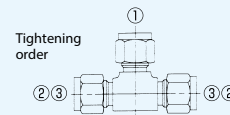

d. Changing the Orientation of an Assembled Elbow Union

Loosen the fitting at Location A before attempting to change its orientation. Failure to do so will strip the threads and result in leakage that cannot be stopped by retightening the fitting.

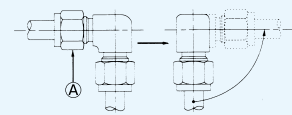

- Support longer tubes to control vibration and prevent movement. If there is minor vibration, the line should be supported at every 2m interval. If there is significant vibration, the line should be supported at every 1m interval.

● Troubleshooting

Fujikin POWERFUL FULOK fittings are manufactured to the most rigorous quality control standards. Leakage should not occur if the fittings are installed and used properly. However, should leakage occur, take the following measures.

- Leakage may occur if there is difficult installation or slant tubing. In this case, please relieve the pressure without untightening the nut, and take additional tightening by $1/8$ -turn. If there is still leakage, take the procedure "Reassembly" in the above, after untightening the nut.

- If leakage persists after the nut has been tightened, it may be caused by the following:

- Fitting damage caused by forcible overtightening.
- Fitting eroded or corroded by the fluid media.
- Corrosion caused by a reaction between leak detection fluid and the fluid media.
- Incorrect fitting assembly.
- Fitting and tube size mismatch.

Review the conditions of use, and consult with **Fujikin** if you have any questions.

Valves

Ball Valves

3-Pieces Ball Valves

Trunnion Ball Valves

Plug Valves

Union-Bonnet Needle Valves

Integral-Bonnet Needle Stop Valves

Brass Needle Stop Valves

Instrument Manifolds / Gauge Valves

Bellows Valves

Toggle Valves

Relief Valves

Check Valves

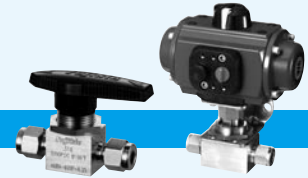

Features

VUBV-920 Series

1. Simple design with one piece body
2. Tight and smooth, low torque and easy operation
3. One-piece ball stem
4. Panel mountable
5. End Connections **V-Lok**, Female pipe (NPT)

VUBVS, VUBVST-920 Series

1. Reduction the parts which may leak by one-piece seat
2. Self-compensation of the wear of a seat by the spring structure of a gland
3. Simple design with one piece body
4. Tight and smooth, low torque and easy operation
5. One-piece ball stem
6. Panel mountable
7. End Connections **V-Lok**, Rc, Female pipe (NPT)

Technical Data

Working Pressure, Temperature Rating

Types	Nominal Sizes	Working Pressure psig (bar) ※	Temperature °F (°C)
VUBV-920 Series	1/4B, 6, 8, 6.35	3000 (206)	50 (10) – 150 (65)
	3/8B, 1/2B, 10, 12, 9.52, 12.7 19.05	2500 (172)	
VUBVS-920 Series	1/8B, 1/4B, 6, 8, 6.35, 9.52	3000 (206)	-65 (-53) – +300 (+148) ※ 1
	1.6, 3.2, 6.35 (Orifice Small) 3, 6 (Orifice Small) 1/8B (Orifice Small)	2500 (172)	
	VUBVST-920 Series	1.6, 3.2, 6.35 (Orifice Small) 3.6 (Orifice Small)	

※ : Working Pressure: Please refer to following Temperature and Pressure Rating.
 ※ 1 : Getting ready. Begin to sell it soon.

Temperature and Pressure Rating

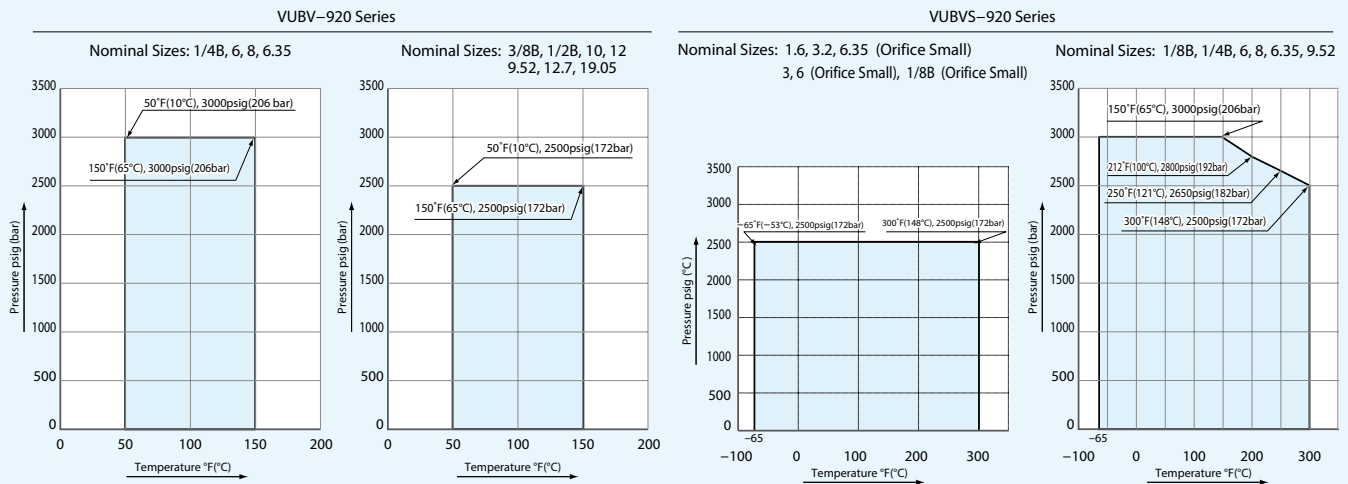

Applicable Fluid

Water, Air, Nitrogen gas, Inert gas like Helium, and non-corrosive gas and liquid.

Materials of Construction

VUBV-920 Series

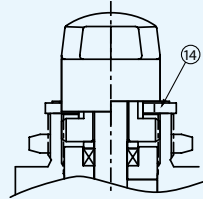
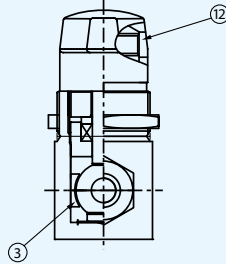
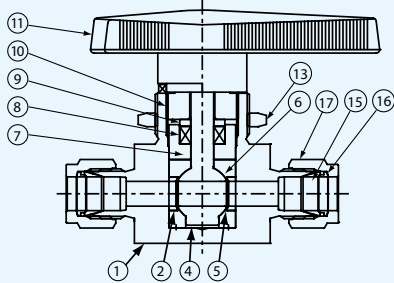

No.	Description		Materials
1	BODY	※	ASTM A479 316
2	RETAINER1	※	SUS316L
3	RETAINER2	※	SUS316L
4	STEM	※	ASTM A276 316
5	SEAT1	※	PTFE
6	SEAT2	※	PTFE
7	PACKING BOX	※	ASTM A276 316
8	GLAND PACKING	※	PTFE
9	PACKING GLAND BUSH		ASTM A276 316
10	PACKING GLAND SCREW		ASTM A276 316
11	HANDLE		NYLON6 + ADC6
12	SET SCREW		S17400 or SUS630
13	PANEL NUT		ASTM A276 304 or ASTM A276 316
14	SPACER	※※	ASTM A276 304

※ : Wetted Parts

※※ : End Connections: V-Lok Tube Fitting types, 12.7, 19.05, 12, 1/2in. Female pipe (NPT), Rc1/2

VUBVS-920 Series

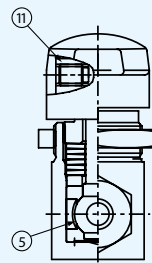
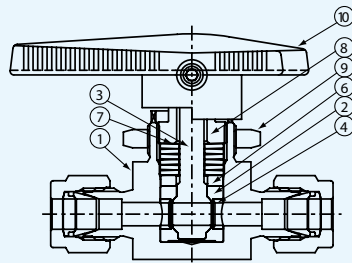

No.	Description		Materials
1	BODY	※	ASTM A479 316
2	SEAT	※	PTFE
3	STEM	※	ASTM A276 316
4	RETAINER1	※	SUS316L
5	RETAINER2	※	SUS316L
6	GLAND		ASTM A276 316
7	DISH SPRING		S17700 or SUS631
8	PACKING GLAND SCREW		ASTM A276 316
9	PANEL NUT		ASTM A276 304 or 316
10	HANDLE		NYLON6 + SUS316L
11	SET SCREW		S17400 or SUS630/SUS304 (ORIFICE SMALL)

※ : Wetted Parts

Materials of Construction

VUBV-020 Series ※

※ : Getting ready. Begin to sell it soon.

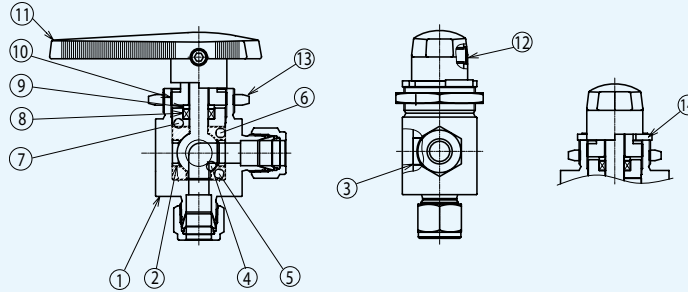

No.	Description	Materials
1	BODY ※	ASTM A479 316
2	RETAINER1 ※	SUS316L
3	RETAINER2 ※	SUS316L
4	STEM ※	ASTM A276 316
5	SEAT1 ※	PTFE
6	SEAT2 ※	PTFE
7	PACKING BOX ※	ASTM A276 316
8	GLAND PACKING ※	PTFE
9	PACKING GLAND BUSH	ASTM A276 316
10	PACKING GLAND SCREW	ASTM A276 316
11	HANDLE	NYLON6 + ADC6
12	SET SCREW	S17400 or SUS630
13	PANEL NUT	ASTM A276 304 or 316
14	SPACER ※※	ASTM A276 304

※ : Wetted Parts

※※ : End Connections: **V-Lok** Tube Fitting types, 12.7, 19.05, 12, 1/2in. Female pipe (NPT), Rc1/2

VUBVS-020 Series ※

※ : Getting ready. Begin to sell it soon.

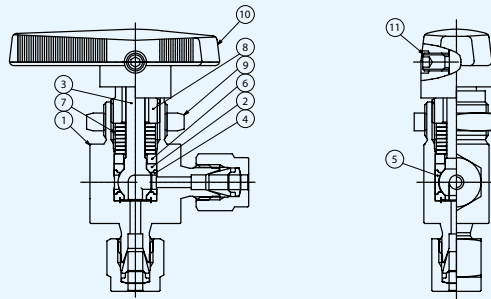

No.	Description	Materials
1	BODY ※	ASTM A479 316
2	SEAT ※	PTFE
3	STEM ※	ASTM A276 316
4	RETAINER1 ※	SUS316L
5	RETAINER2 ※	SUS316L
6	GLAND ※	ASTM A276 316
7	DISH SPRING	S17700 or SUS631
8	PACKING GLAND SCREW	ASTM A276 316
9	PANEL NUT	ASTM A276 304 or 316
10	HANDLE	NYLON6 + SUS316
11	SET SCREW	S17400 or SUS630/SUS304 (ORIFICE SMALL)

※ : Wetted Parts

Materials of Construction

VUBVT-920 Series ※

※ : Getting ready. Begin to sell it soon.

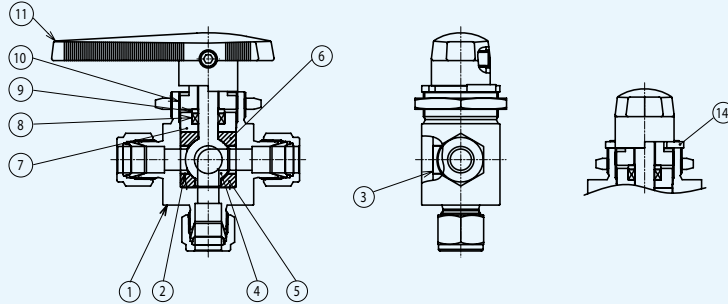

No.	Description	Materials
1	BODY ※	ASTM A479 316
2	RETAINER1 ※	SUS316L
3	RETAINER2 ※	SUS316L
4	STEM ※	ASTM A276 316
5	SEAT1 ※	PTFE
6	SEAT2 ※	PTFE
7	PACKING BOX ※	ASTM A276 316
8	GLAND PACKING ※	PTFE
9	PACKING GLAND BUSH	ASTM A276 316
10	PACKING GLAND SCREW	ASTM A276 316
11	HANDLE	NYLON6 + ADC6
12	SET SCREW	S17400 or SUS630
13	PANEL NUT	ASTM A276 304 or 316
14	SPACER ※※	ASTM A276 304

※ : Wetted Parts

※※ : End Connections: **V-Lok** Tube Fitting types, 12.7, 19.05, 12, 1/2in. Female pipe (NPT), Rc1/2

VUBVST-920 Series ※

※ : Getting ready. Begin to sell it soon.

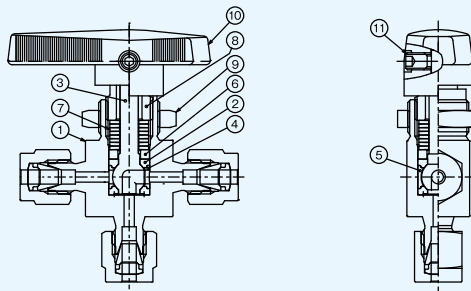

No.	Description	Materials
1	BODY ※	ASTM A479 316
2	SEAT ※	PTFE
3	STEM ※	ASTM A276 316
4	RETAINER1 ※	SUS316L
5	RETAINER2 ※	SUS316L
6	GLAND	ASTM A276 316
7	DISH SPRING	S17700 or SUS631
8	PACKING GLAND SCREW	ASTM A276 316
9	PANEL NUT	ASTM A276 304 or 316
10	HANDLE	NYLON6 + SUS316
11	SET SCREW	S17400 or SUS630/SUS304 (ORIFICE SMALL)

※ : Wetted Parts

Dimensions

Manual Valves

VUBV / VUBVS-920 Series

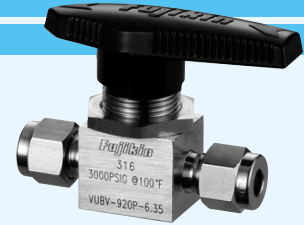
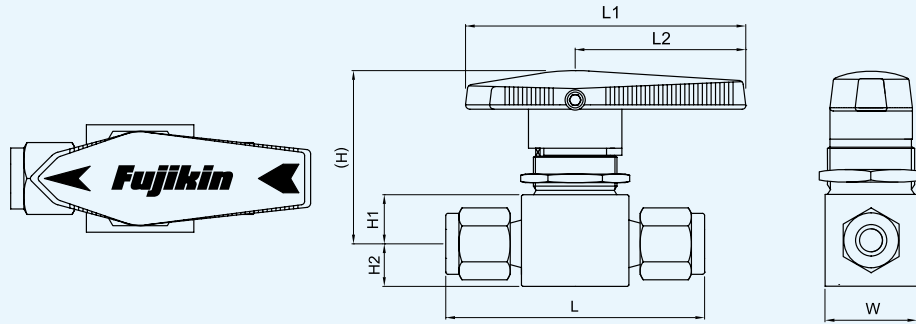

Connections	Nominal Dia. inch (mm)	Working Pressure psig (bar)	Orifice inch (mm)	Dimensions inch (mm)							Ordering Numbers			
				L	L1	L2	H	H1	H2	W	VUBV-920 Series	VUBVS-920 Series		
V-Lok	1/16 (1.6)	2500 (172)	0.051 (1.3)	1.68 (42.7)	1.87 (47.4)	1.12 (28.4)	1.36 (34.5)	0.34 (8.6)	0.28 (7.1)	0.58 (14.7)	-	VUBVS-920P-1.6-B ※		
	1/8 (3.2)		0.094 (2.4)	2.01 (51.1)							-	VUBVS-920P-3.2-B ※		
	1/4 (6.35)		0.13 (3.2)	2.21 (56.1)							-	VUBVS-920P-6.35-S-B ※		
	1/4 (6.35)	3000 (206)	0.19 (4.8)	2.39 (60.7)	2.52 (63.9)	1.53 (38.9)	1.47 (37.3)	0.44 (11.2)	0.38 (9.7)	0.78 (19.8)	VUBV-920P-6.35	VUBVS-920P-6.35		
	3/8 (9.52)			2.58 (65.5)							-	VUBVS-920P-9.52		
	3/8 (9.52)	2500 (172)	0.28 (7.1)	3.05 (77.5)	3.26 (82.8)	2 (50.8)	2.07 (52.6)	0.56 (14.2)		1.12 (28.4)	VUBV-920P-9.52	-		
	1/2 (12.7)			0.41 (10.3)							3.92 (99.6)	4.26 (108.2)	3 (76.2)	2.43 (61.7)
	3/4 (19.05)			0.094 (2.4)	2.01 (51.1)	1.87 (47.4)	1.12 (28.4)	1.36 (34.5)	0.34 (8.6)	0.28 (7.1)	0.58 (14.7)	-	VUBVS-920P-3-B ※	
	- (3)			0.13 (3.2)	2.21 (56.1)							-	VUBVS-920P-6-S-B ※	
	- (6)			3000 (206)	0.19 (4.8)	2.39 (60.7)	2.52 (63.9)	1.53 (38.9)	1.47 (37.3)	0.44 (11.2)	0.38 (9.7)	0.78 (19.8)	VUBV-920P-6	VUBVS-920P-6
	- (8)					2.46 (62.5)							-	VUBVS-920P-8
	- (10)	2500 (172)	0.28 (7.1)	3.07 (78)	3.26 (82.8)	2 (50.8)	2.07 (52.6)	0.56 (14.2)		1.12 (28.4)	VUBV-920P-10	-		
	- (12)			0.41 (10.3)							3.92 (99.6)	4.26 (108.2)	3 (76.2)	2.43 (61.7)
	Female NPT	1/8	2500 (172)	0.13 (3.2)	1.63 (41.4)	1.87 (47.4)	1.12 (28.4)	1.36 (34.5)	0.34 (8.6)	0.28 (7.1)	0.58 (14.7)	-	VUBVS-120PAN-S-B ※	
1/8		3000 (206)	0.19 (4.8)	2 (50.8)	2.52 (63.9)	1.53 (38.9)	1.47 (37.3)	0.44 (11.2)	0.38 (9.7)	0.78 (19.8)	-	VUBVS-120PAN		
				2.06 (52.3)							VUBV-120PBN	VUBVS-120PBN		
1/4		2500 (172)	0.28 (7.1)	2.5 (63.5)	3.26 (82.8)	2 (50.8)	2.07 (52.6)	0.56 (14.2)		1.12 (28.4)	VUBV-120PCN	-		
3/8				0.41 (10.3)							3.012 (79.2)	4.26 (108.2)	3 (76.2)	2.43 (61.7)
1/2	0.13 (3.2)			1.63 (41.4)	1.87 (47.4)	1.12 (28.4)	1.36 (34.5)	0.34 (8.6)	0.28 (7.1)	0.58 (14.7)	-	VUBVS-120PA-S-B ※		
Rc	1/8	2500 (172)	0.13 (3.2)	1.63 (41.4)	1.87 (47.4)	1.12 (28.4)	1.36 (34.5)	0.34 (8.6)	0.28 (7.1)	0.58 (14.7)	-	VUBVS-120PA		
	1/8	3000 (206)	0.19 (4.8)	2 (50.8)	2.52 (63.9)	1.53 (38.9)	1.47 (37.3)	0.44 (11.2)	0.38 (9.7)	0.78 (19.8)	-	VUBVS-120PA		
				2.06 (52.3)							VUBV-120PB	VUBVS-120PB		
	1/4	2500 (172)	0.28 (7.1)	2.5 (63.5)	3.26 (82.8)	2 (50.8)	2.07 (52.6)	0.56 (14.2)		1.12 (28.4)	VUBV-120PC	-		
	3/8			0.41 (10.3)							3.012 (79.2)	4.26 (108.2)	3 (76.2)	2.43 (61.7)
1/2	0.13 (3.2)			1.63 (41.4)	1.87 (47.4)	1.12 (28.4)	1.36 (34.5)	0.34 (8.6)	0.28 (7.1)	0.58 (14.7)	-	VUBVS-120PA-S-B ※		

※ : Getting ready. Begin to sell it soon.

It's possible to be interchangeable about a Ordering Number mentioned in parallel (background color: Light blue) and change. VUBV can be distinguished from VUBVS by handle direction.

Dimensions

Manual Valves

VUBV / VUBVS-020 Series

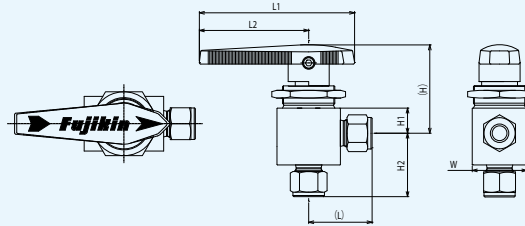

Connections	Nominal Dia. inch (mm)	Working Pressure psig (bar)	Orifice inch (mm)	Dimensions inch (mm)							Ordering Numbers		
				L	L1	L2	H	H1	H2	W	VUBV-020 Series	VUBVS-020 Series	
V-Lok	1/8 (3.2)	2500 (172)	0.094 (2.4)	0.97 (24.6)	1.87 (47.4)	1.12 (28.4)	1.36 (34.5)	0.34 (8.6)	0.97 (24.6)	0.58 (14.7)	-	VUBVS-020P-3.2-B ※	
	1/4 (6.35)		0.13 (3.2)	1.07 (27.2)				1.07 (27.2)			-	VUBVS-020P-6.35-S-B ※	
	3/8 (9.52)		0.28 (7.1)	1.43 (36.3)	3.26 (82.8)	2 (50.8)	2.07 (52.6)	0.56 (14.2)	1.43 (36.3)	1.12 (28.4)	VUBV-020P-9.52-B	-	※
	0.12 (3)		0.094 (2.4)	2.01 (51.1)	1.87 (47.4)	1.12 (28.4)	1.36 (34.5)	0.34 (8.6)	0.97 (24.6)	0.58 (14.7)	-	VUBVS-020P-3-B ※	
	0.24 (6)		0.13 (3.2)	2.21 (56.1)					1.07 (27.2)		-	VUBVS-020P-6-S-B ※	
Female NPT	1/8 (-)		0.13 (3.2)	1.63 (41.4)	1.87 (47.4)	1.12 (28.4)	1.36 (34.5)	0.34 (8.6)	0.81 (20.6)	0.58 (14.7)	-	VUBVS-320PAN-S-B ※	
Rc	1/8 (-)		0.13 (3.2)	1.63 (41.4)	1.87 (47.4)	1.12 (28.4)	1.36 (34.5)	0.34 (8.6)	0.81 (20.6)	0.58 (14.7)	-	VUBVS-320PA-S-B ※	

※ : Getting ready. Begin to sell it soon.

VUBVT / VUBVST-920 Series

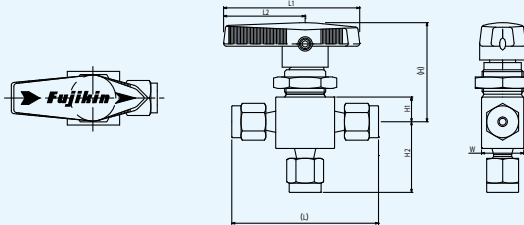

Connections	Nominal Dia. inch (mm)	Working Pressure psig (bar)	Orifice inch (mm)	Dimensions inch (mm)							Ordering Numbers		
				L	L1	L2	H	H1	H2	W	VUBVT-920 Series	VUBVST-920 Series	
V-Lok	1/16 (1.6)	2500 (172)	0.051 (1.3)	1.68 (42.7)					0.81 (20.6)		-	VUBVST-920P-1.6-B ※	
	1/8 (3.2)		0.094 (2.4)	2.01 (51.1)	1.87 (47.4)	1.12 (28.4)	1.36 (34.5)	0.34 (8.6)	0.97 (24.6)	0.58 (14.7)	-	VUBVST-920P-3.2-B ※	
	1/4 (6.35)		0.13 (3.2)	2.21 (56.1)					1.07 (27.2)		-	VUBVST-920P-6.35-S-B ※	
	3/8 (9.52)		0.28 (7.1)	2.89 (73.4)	3.26 (82.8)	2 (50.8)	2.07 (52.6)	0.56 (14.2)	1.43 (36.3)	1.12 (28.4)	VUBVT-920P-9.52-B	-	※
	0.12 (3)		0.094 (2.4)	2.01 (51.1)	1.87 (47.4)	1.12 (28.4)	1.36 (34.5)	0.34 (8.6)	0.97 (24.6)	0.58 (14.7)	-	VUBVST-920P-3-B ※	
	0.24 (6)		0.13 (3.2)	2.21 (56.1)					1.07 (27.2)		-	VUBVST-920P-6-S-B ※	
Female NPT	1/8 (-)		0.13 (3.2)	1.63 (41.4)	1.87 (47.4)	1.12 (28.4)	1.36 (34.5)	0.34 (8.6)	0.81 (20.6)	0.58 (14.7)	-	VUBVST-120PAN-S-B ※	
Rc	1/8 (-)		0.13 (3.2)	1.63 (41.4)	1.87 (47.4)	1.12 (28.4)	1.36 (34.5)	0.34 (8.6)	0.81 (20.6)	0.58 (14.7)	-	VUBVST-120PA-S-B ※	

※ : Getting ready. Begin to sell it soon.

Dimensions

Automated Valves

APR-VUBV / VUBVS-920 Series

Spring Return Type

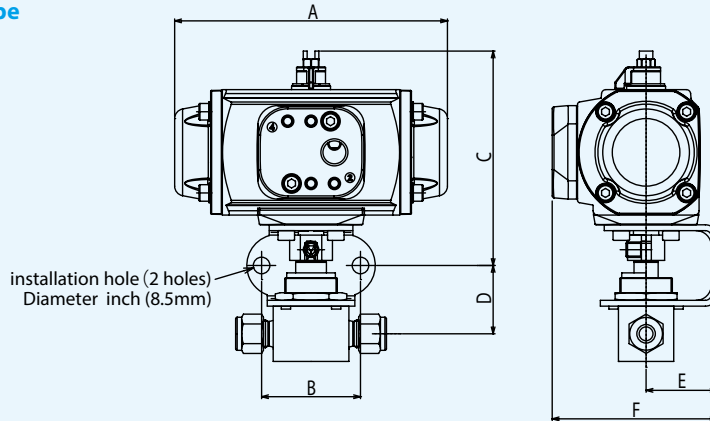

Connections	Nominal Dia. inch (mm)	Actuator Type	Dimensions inch (mm)						Ordering Numbers		
			A	B	C	D	E	F	APR-VUBV-920 Series	APR-VUBVS-920 Series	
V-Lok	1/4 (6.35)	AC2S	5.52 (140.2)	2 (50.8)	4.18 (106.1)	1.1 (27.9)	1.44 (36.5)	3.66 (93)	-	APR-VUBVS-920P-6.35	※
	3/8 (9.52)				4.33 (109.9)	1.38 (35.1)			-	APR-VUBVS-920P-9.52	※
	3/8 (9.52)				APR-VUBV-920P-9.52	-			※		
	1/2 (12.7)	AC3S	6 (152.3)	2.19 (55.6)	4.93 (125.1)	1.61 (40.9)	1.73 (44)	4.13 (105)	APR-VUBV-920P-12.7	-	※
	3/4 (19.05)				APR-VUBV-920P-19.05	-			※		
	- (6)	AC2S	5.52 (140.2)	2 (50.8)	4.18 (106.1)	1.1 (27.9)	1.44 (36.5)	3.66 (93)	-	APR-VUBVS-920P-6	※
	- (8)				4.33 (109.9)	1.38 (35.1)			-	APR-VUBVS-920P-8	※
	- (10)				APR-VUBV-920P-10	-			※		
- (12)	AC3S	6 (152.3)	2.19 (55.6)	4.93 (125.1)	1.61 (40.9)	1.73 (44)	4.13 (105)	APR-VUBV-920P-12	-	※	
Female NPT	1/8 (-)	AC2S	5.52 (140.2)	2 (50.8)	4.18 (106.1)	1.1 (27.9)	1.44 (36.5)	3.66 (93)	-	APR-VUBVS-120PAN	※
	1/4 (-)				4.33 (109.9)	1.38 (35.1)			-	APR-VUBVS-120PBN	※
	3/8 (-)				APR-VUBV-120PCN	-			※		
	1/2 (-)	AC3S	6 (152.3)	2.19 (55.6)	4.93 (125.1)	1.61 (40.9)	1.73 (44)	4.13 (105)	APR-VUBV-120PDN	-	※
Rc	1/8 (-)	AC2S	5.52 (140.2)	2 (50.8)	4.18 (106.1)	1.1 (27.9)	1.44 (36.5)	3.66 (93)	-	APR-VUBVS-120PA-S	※
	1/8 (-)				4.33 (109.9)	1.38 (35.1)			-	APR-VUBVS-120PA	※
	1/4 (-)				APR-VUBV-120PB	-			※		
	3/8 (-)				APR-VUBV-120PC	-			※		
	1/2 (-)	AC3S	6 (152.3)	2.19 (55.6)	4.93 (125.1)	1.61 (40.9)	1.73 (44)	4.13 (105)	APR-VUBV-120PD	-	※

※: Getting ready. Begin to sell it soon.

Dimensions

Automated Valves

APDM-VUBV / VUBVS-920 Series

Double Acting Type

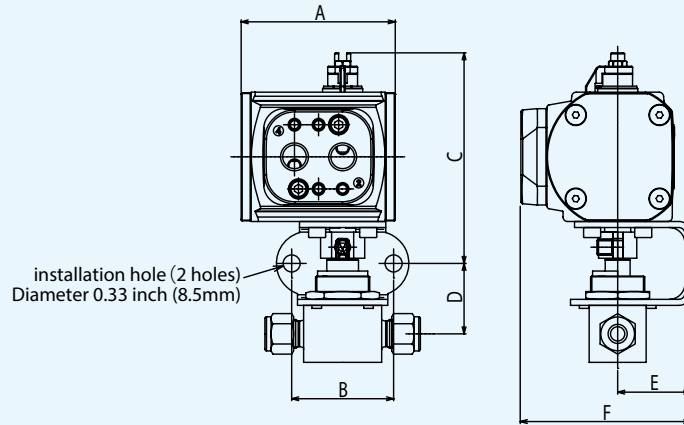

Connections	Nominal Dia. inch (mm)	Actuator Type	Dimensions inch (mm)						Ordering Numbers		
			A	B	C	D	E	F	APDM-VUBV-920 Series	APDM-VUBVS-920 Series	
V-Lok	1/4 (6.35)	AC1	3.02 (76.8)	2 (50.8)	3.98 (101.1)	1.1 (27.9)	1.44 (36.5)	3.33 (84.7)	-	APDM-VUBVS-920P-6.35	※
	3/8 (9.52)				4.13 (104.9)	1.38 (35.1)			-	APDM-VUBVS-920P-9.52	※
	3/8 (9.52)				-	-			APDM-VUBV-920P-9.52	-	※
	1/2 (12.7)	AC2	3.98 (101)	2.19 (55.6)	4.45 (113.1)	1.61 (40.9)	1.73 (44)	3.63 (92.2)	APDM-VUBV-920P-12.7	-	※
	3/8 (19.05)				4.45 (113.1)	1.61 (40.9)			1.73 (44)	3.63 (92.2)	APDM-VUBV-920P-19.05
	- (6)	AC1	3.02 (76.8)	2 (50.8)	3.98 (101.1)	1.1 (27.9)	1.44 (36.5)	3.33 (84.7)	-	APDM-VUBVS-920P-6	※
	- (8)				4.13 (104.9)	1.38 (35.1)			-	APDM-VUBVS-920P-8	※
	- (10)				-	-			APDM-VUBV-920P-10	-	※
- (12)	3.98 (101)				2.19 (55.6)	4.45 (113.1)			1.61 (40.9)	1.73 (44)	3.63 (92.2)
Female NPT	1/8 (-)	AC1	3.02 (76.8)	2 (50.8)	3.98 (101.1)	1.1 (27.9)	1.44 (36.5)	3.33 (84.7)	-	APDM-VUBVS-120PAN	※
	1/4 (-)				4.13 (104.9)	1.38 (35.1)			-	APDM-VUBVS-120PBN	※
	3/8 (-)				-	-			APDM-VUBV-120PCN	-	※
	1/2 (-)	AC2	3.98 (101)	2.19 (55.6)	4.45 (113.1)	1.61 (40.9)	1.73 (44)	3.63 (92.2)	APDM-VUBV-120PDN	-	※
Rc	1/8 (-)	AC1	3.02 (76.8)	2 (50.8)	3.98 (101.1)	1.1 (27.9)	1.44 (36.5)	3.33 (84.7)	-	APDM-VUBVS-120PA-S	※
	1/8 (-)								-	APDM-VUBVS-120PA	※
	1/4 (-)								-	APDM-VUBVS-120PB	※
	3/8 (-)								APDM-VUBV-120PC	-	※
	1/2 (-)	AC2	3.98 (101)	2.19 (55.6)	4.45 (113.1)	1.61 (40.9)	1.73 (44)	3.63 (92.2)	APDM-VUBV-120PD	-	※

※: Getting ready. Begin to sell it soon.

Ordering Information

APR –
 VUBVT –
 920P –
 6.35S –
 B –
 KL

- ① Actuator Type
APR : Spring Back Type
APDM : Double Acting Type
Blank: Manual Type
- ② Valve Series
- ③ Body Material
Stainless Steel
- ④ Valve Type
BV: Ball Valves
BVS: One-piece Seat Ball Valves
- ⑤ Valve Type
Blank: 2-Way Valve
T : 3-Way Valve
- ⑥ End Connections
1: Thread Type
9: **V-Lok** Type
- ⑦ Working Pressure
20 : 206 bar
- ⑧ Panel Mount Type
- ⑨ Connection Sizes
1.6 : **V-Lok** 1.6
3.2 : **V-Lok** 3.2
6.35 : **V-Lok** 6.35
9.52 : **V-Lok** 9.52
12.7 : **V-Lok** 12.7
19.05 : **V-Lok** 19.05
3 : **V-Lok** 3
6 : **V-Lok** 6
8 : **V-Lok** 8
10 : **V-Lok** 10
12 : **V-Lok** 12
- ⑩ Orifice
Blank : Standard
S : Small
- ⑪ Handle Color

Handle Color	Code
Blue	-B
Green	-G
Orange	-YR
Red	-RE
Yellow	-Y
Black	-
- ⑫ Key Lock
Blank : without Key Lock
KL : with Key Lock

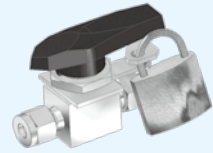

Features

1. Large flowrate with 3 pieces body.
2. ON-OFF by operation of quarter turn.
3. End Connections: **V-Lok** Type, Rc, NPT Female
4. Manual Valves, Automated Valves
(Spring Back, Double Action Type)



Technical Data

Temperature and Pressure Rating

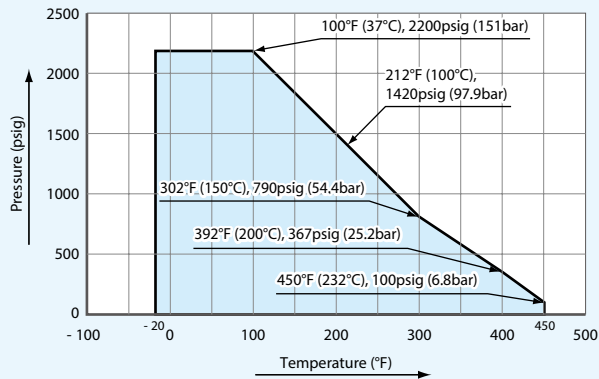

Applicable Fluid

Air, Nitrogen gas, Inert gas like Helium, and non-corrosive gas and liquid.

Materials of Construction

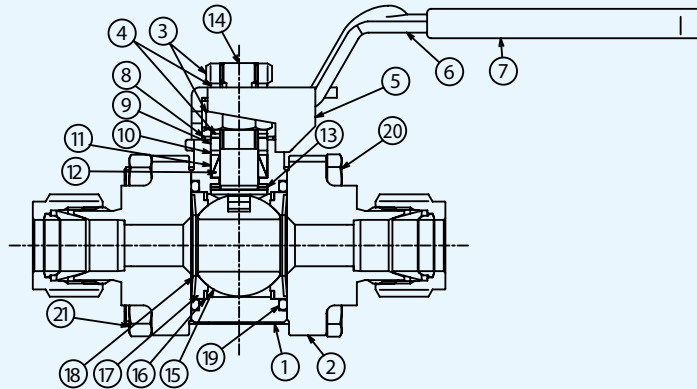

No.	Description	Materials	No.	Description	Materials
1	BODY ※	ASTM A351 CF3M	12	BOTTOM PACKING ※	C - PTFE
2	FLANGE ※	ASTM A351 CF3M	13	STEM BEARING ※	SUS316
3	STEM NUT	ASTM A276 316	14	STEM	ASTM A240 316
4	STEM SPRING	SUS304 - CSP	15	BALL ※	ASTM A240 316 or ASTM A351 CF8M
5	STOP PLATE	ASTM A240 304	16	SUPPORT RING ※	ASTM A240 316
6	HANDLE	ASTM A240 304	17	SEAT ※	C - PTFE
7	HANDLE SLEEVE	VINYL	18	SEAT SPRING ※	SUS304 - CSP
8	EARTH SPRING	ASTM A313 302	19	O-RING ※	FKM
9	GLAND	ASTM B783 316	20	BOLT	SUS316
10	PACKING SUPPORT	PEEK	21	BOLT NUT	SUS316
11	TOP PACKING ※	C - PTFE			

※ : Wetted Parts

Dimensions

Manual Valves

End Connections V-Lok Type

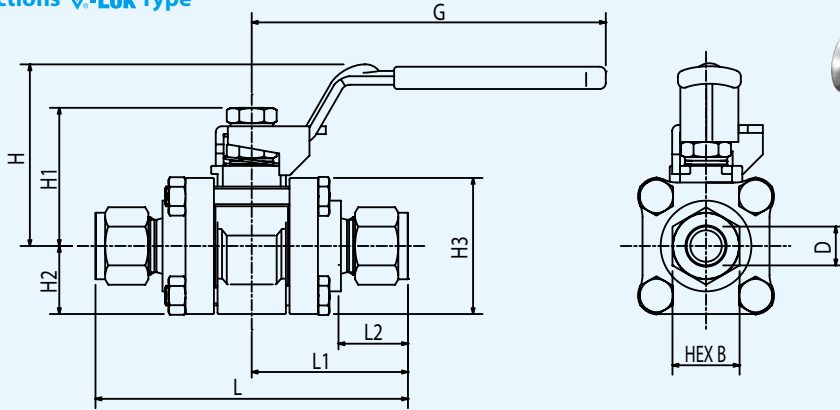

Sizes D	Orifice in. (mm)	Dimensions inch (mm)									Ordering Numbers
		L	L1	L2	B	H	H1	H2	H3	G	
1/4in.(6.35)	0.189 (4.8)	3.17 (80.5)	1.59 (40.4)	0.6 (15.2)	9/16 in.	1.66 (42.2)	1.26 (32)	0.68 (17.3)	1.35 (34.3)	2.37 (60.2)	VUBV - 915 - 6.35
3/8in.(9.52)	0.28 (7.1)	3.17 (80.5)	1.59 (40.4)	0.66 (16.8)	11/16 in.	1.66 (42.2)	1.26 (32)	0.68 (17.3)	1.35 (34.3)	2.37 (60.2)	VUBV - 915 - 9.52
1/2in.(12.7)	0.406 (10.3)	4.06 (103)	2.02 (51.3)	0.9 (22.9)	7/8 in.	2.35 (59.7)	1.79 (45.5)	0.89 (22.6)	1.78 (45.2)	4.49 (114)	VUBV - 915 - 12.7
3/4in.(19.05)	0.516 (13.1)	4.06 (103)	2.02 (51.3)	0.96 (24.4)	1 - 1/8 in.	2.35 (59.7)	1.79 (45.5)	0.89 (22.6)	1.78 (45.2)	4.49 (114)	VUBV - 915 - 19.05
1in.(25.4)	0.874 (22.2)	5.35 (136)	2.68 (68.1)	1.23 (31.2)	1 - 1/2 in.	2.94 (74.7)	2.52 (64)	1.25 (31.8)	2.5 (63.5)	5.98 (152)	VUBV - 915 - 25.4
6	0.189 (4.8)	3.17 (80.5)	1.59 (40.4)	0.6 (15.3)	0.55 (14)	1.66 (42.2)	1.26 (32)	0.68 (17.3)	1.35 (34.3)	2.37 (60.2)	VUBV - 915 - 6
8	0.252 (6.4)	3.17 (80.5)	1.59 (40.4)	0.64 (16.2)	0.63 (16)	1.66 (42.2)	1.26 (32)	0.68 (17.3)	1.35 (34.3)	2.37 (60.2)	VUBV - 915 - 8
10	0.28 (7.1)	3.2 (81.3)	1.6 (40.6)	0.68 (17.2)	0.75 (19)	1.66 (42.2)	1.26 (32)	0.68 (17.3)	1.35 (34.3)	2.37 (60.2)	VUBV - 915 - 10
12	0.374 (9.5)	4.06 (103)	2.02 (51.3)	0.9 (22.8)	0.87 (22)	2.35 (59.7)	1.79 (45.5)	0.89 (22.6)	1.78 (45.2)	4.49 (114)	VUBV - 915 - 12

End Connections: Rc Type

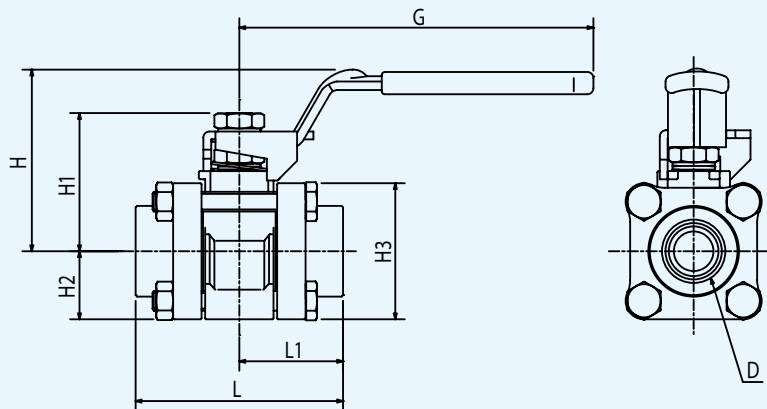

Sizes	Orifice in. (mm)	End Connections D	Dimensions inch (mm)						Ordering Numbers	
			L	L1	H	H1	H2	H3		G
1/4 in.	0.28 (7.1)	Rc 1/4	2.16 (54.9)	1.08 (27.4)	1.66 (42.2)	1.26 (32)	0.68 (17.3)	1.35 (34.3)	2.37 (60.2)	VUBV - 115B
3/8 in.	0.516 (13.1)	Rc 3/8	2.7 (68.6)	1.35 (34.3)	2.35 (59.7)	1.79 (45.5)	0.89 (22.6)	1.78 (45.2)	4.49 (114)	VUBV - 115C
1/2 in.	0.516 (13.1)	Rc 1/2	2.7 (68.6)	1.35 (34.3)	2.35 (59.7)	1.79 (45.5)	0.89 (22.6)	1.78 (45.2)	4.49 (114)	VUBV - 115D
3/4 in.	0.874 (22.2)	Rc 3/4	3.59 (91.2)	1.8 (45.7)	2.94 (74.7)	2.52 (64)	1.25 (31.8)	2.5 (63.5)	5.98 (152)	VUBV - 115E
1 in.	0.874 (22.2)	Rc 1	4.45 (113)	2.23 (56.6)	2.94 (74.7)	2.52 (64)	1.25 (31.8)	2.5 (63.5)	5.98 (152)	VUBV - 115F

Dimensions

Manual Valves

End Connections: Female NPT Type

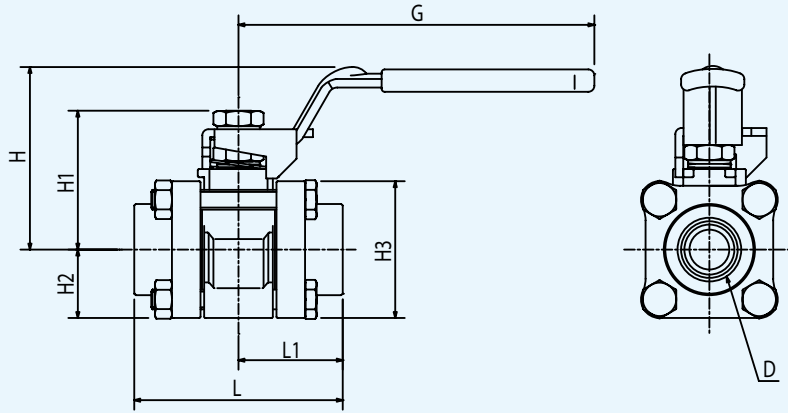

Sizes	Orifice in. (mm)	End Connections D	Dimensions inch (mm)							Ordering Numbers
			L	L1	H	H1	H2	H3	G	
1/4 in.	0.28 (7.1)	1/4 NPT	2.16 (54.9)	1.08 (27.4)	1.66 (42.2)	1.26 (32)	0.68 (17.3)	1.35 (34.3)	2.37 (60.2)	VUBV - 115BN
3/8 in.	0.516 (13.1)	3/8 NPT	2.7 (68.6)	1.35 (34.3)	2.35 (59.7)	1.79 (45.5)	0.89 (22.6)	1.78 (45.2)	4.49 (114)	VUBV - 115CN
1/2 in.	0.516 (13.1)	1/2 NPT	2.7 (68.6)	1.35 (34.3)	2.35 (59.7)	1.79 (45.5)	0.89 (22.6)	1.78 (45.2)	4.49 (114)	VUBV - 115DN
3/4 in.	0.874 (22.2)	3/4 NPT	3.59 (91.2)	1.8 (45.7)	2.94 (74.7)	2.52 (64)	1.25 (31.8)	2.5 (63.5)	5.98 (152)	VUBV - 115EN
1 in.	0.874 (22.2)	1 NPT	4.45 (113)	2.23 (56.6)	2.94 (74.7)	2.52 (64)	1.25 (31.8)	2.5 (63.5)	5.98 (152)	VUBV - 115FN

Dimensions

Automated Valves

Spring Return Type

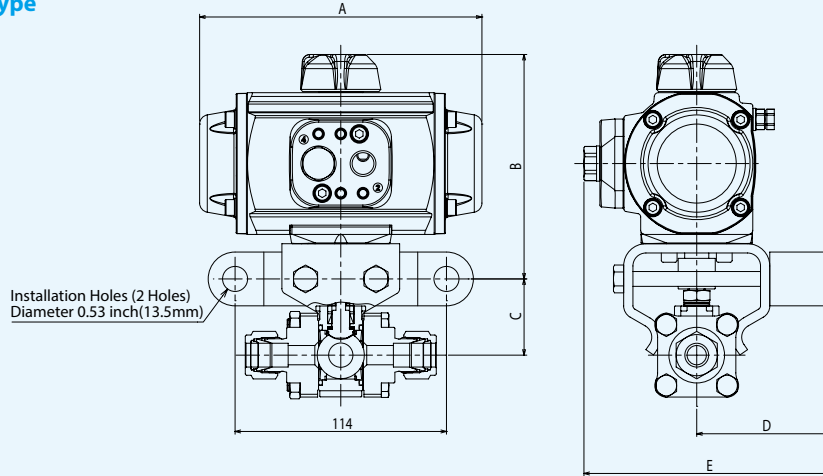

Connection Type	Nominal Diameter Inch (mm)	Actuator Type	Dimensions Inch (mm)					Ordering Numbers
			A	B	C	D	E	
V-Lok	1/4 (6.35)	AC2S	5.52 (140.2)	4.26 (108.3)	1.54 (39.1)	2.9 (73.7)	5.14 (130.5)	APR-VUBV-915-6.35
	3/8 (9.52)							APR-VUBV-915-9.52
	1/2 (12.7)	AC3S	6 (152.3)	4.77 (121.1)	1.62 (41.1)	2.92 (74.2)	5.34 (135)	APR-VUBV-915-12.7
	3/4 (19.05)							APR-VUBV-915-19.05
	1 (25.4)	AC4S	7.93 (201.3)	6.05 (153.6)	2.18 (55.4)	3.3 (83.8)	6.07 (154.1)	APR-VUBV-915-25.4
	- (6)	AC2S						APR-VUBV-915-6
	- (8)							APR-VUBV-915-8
	- (10)							APR-VUBV-915-10
	- (12)		AC3S	6 (152.3)	4.77 (121.1)	1.62 (41.1)	2.92 (74.2)	5.34 (135)
Rc	1/4	AC2S	5.52 (140.2)	4.26 (108.3)	1.54 (39.1)	2.9 (73.7)	5.14 (130.5)	APR-VUBV-115B
	3/8	AC3S	6 (152.3)	4.77 (121.1)	1.62 (41.1)	2.92 (74.2)	5.34 (135)	APR-VUBV-115C
	1/2							APR-VUBV-115D
	3/4	AC4S	7.93 (201.3)	6.05 (153.6)	2.18 (55.4)	3.3 (83.8)	6.07 (154.1)	APR-VUBV-115E
	1							APR-VUBV-115F
Female NPT	1/4	AC2S	5.52 (140.2)	4.26 (108.3)	1.54 (39.1)	2.9 (73.7)	5.14 (130.5)	APR-VUBV-115BN
	3/8	AC3S	6 (152.3)	4.77 (121.1)	1.62 (41.1)	2.92 (74.2)	5.34 (135)	APR-VUBV-115CN
	1/2							APR-VUBV-115DN
	3/4	AC4S	7.93 (201.3)	6.05 (153.6)	2.18 (55.4)	3.3 (83.8)	6.07 (154.1)	APR-VUBV-115EN
	1							APR-VUBV-115FN

Dimensions

Automated Valves

Double Acting Type

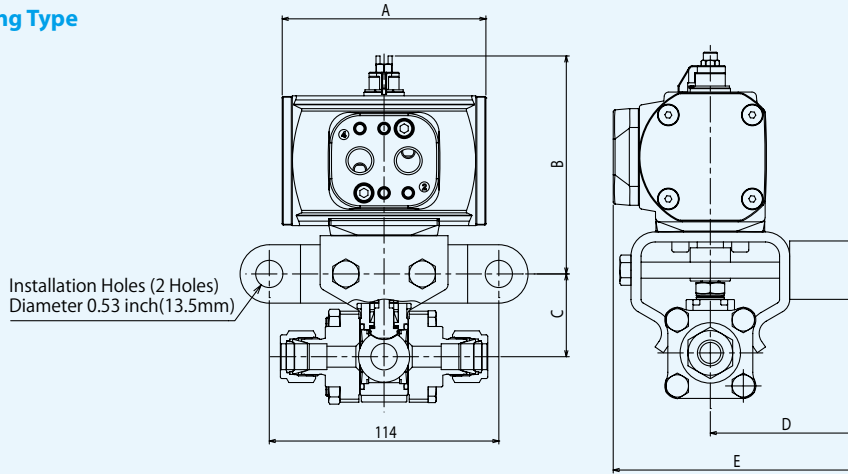

Connection Type	Nominal Diameter Inch (mm)	Actuator Type	Dimensions Inch (mm)					Ordering Numbers
			A	B	C	D	E	
V-Lok	1/4 (6.35)	AC2S	3.02 (76.8)	4.06 (103.1)	1.54 (39.1)	2.9 (73.7)	4.8 (121.9)	APDM-VUBV-915-6.35
	3/8 (9.52)							APDM-VUBV-915-9.52
	1/2 (12.7)	AC3S	3.98 (101.2)	4.26 (108.3)	1.62 (41.1)	2.92 (74.2)	4.82 (122.4)	APDM-VUBV-915-12.7
	3/4 (19.05)							APDM-VUBV-915-19.05
	1 (25.4)	AC4S	5.98 (152.2)	5.38 (136.6)	2.18 (55.4)	3.3 (83.8)	5.35 (136)	APDM-VUBV-915-25.4
	- (6)	AC2S						APDM-VUBV-915-6
	- (8)							APDM-VUBV-915-8
	- (10)							APDM-VUBV-915-10
	- (12)		AC3S	3.98 (101.5)	4.26 (108.3)	1.62 (41.1)	2.92 (74.2)	4.82 (122.4)
Rc	1/4	AC2S	3.02 (76.8)	4.06 (103.1)	1.54 (39.1)	2.9 (73.7)	4.8 (121.9)	APDM-VUBV-115B
	3/8	AC3S	3.98 (101.2)	4.26 (108.3)	1.62 (41.1)	2.92 (74.2)	4.82 (122.4)	APDM-VUBV-115C
	1/2							APDM-VUBV-115D
	3/4	AC4S	5.98 (152.2)	5.38 (136.6)	2.18 (55.4)	3.3 (83.8)	5.35 (136)	APDM-VUBV-115E
	1							APDM-VUBV-115F
Female NPT	1/4	AC2S	3.02 (76.8)	4.06 (103.1)	1.54 (39.1)	2.9 (73.7)	4.8 (121.9)	APDM-VUBV-115BN
	3/8	AC3S	3.98 (101.2)	4.26 (108.3)	1.62 (41.1)	2.92 (74.2)	4.82 (122.4)	APDM-VUBV-115CN
	1/2							APDM-VUBV-115DN
	3/4	AC4S	6 (152.3)	5.38 (136.6)	2.18 (55.4)	3.3 (83.8)	5.35 (136)	APDM-VUBV-115EN
	1							APDM-VUBV-115FN

Ordering Information

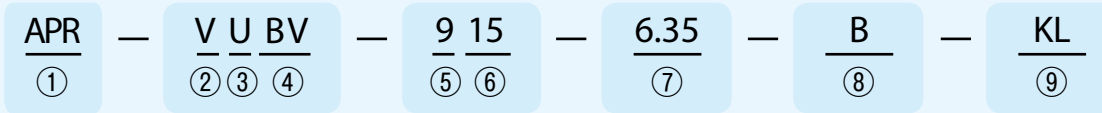

- | | | |
|---|--|---|
| <p>① Actuator Type
APR : Spring Return Type
APDM : Double Acting type
Blank : Manual Type</p> <p>② Valve Series</p> <p>③ Body Material
Stainless Steel</p> <p>④ Valve Type
Ball Valves</p> <p>⑤ End Connections
1 : Thread Type
9 : V-Lok Type</p> | <p>⑥ Working Pressure
2200 psig
(151 bar)</p> <p>⑦ Connection Sizes
6.35 : V-Lok 1/4
9.52 : V-Lok 3/8
12.7 : V-Lok 1/2
19.05 : V-Lok 3/4
25.4 : V-Lok 1
6 : V-Lok 6
8 : V-Lok 8
10 : V-Lok 10
12 : V-Lok 12</p> | <p>⑧ Handle Color
— : Black
B : Blue
G : Green
YR : Orange
RE : Red
Y : Yellow</p> <p>⑨ Key Lock Type
Blank : without Key Lock
KL : with Key Lock</p> |
|---|--|---|

Option

Handle Color

Standard Handle Color is black.

When you ordered a colored handle besides the black.
Please put the relevant symbol to the part number end from beside table.

Ex. Ordering Number in case of you will order blue handle
VUBV-941P-6.35-B

HANDLE Color	The end of Ordering Numbers
Black	—
Blue	-B
Green	-G
Orange	-YR
Red	-RE
Yellow	-Y

Key Lock & Bracket

- Locking with standard parts for lock , and with a handle of flow direction locking certainly at open or close for 2-way valves
- Possible to fix a locking part on the hole in the bracket or install a distinction tag.
- After installing to a panel, it isn't possible to install a bracket.

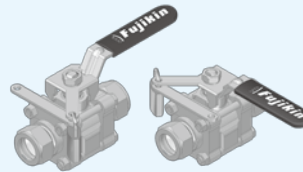

When a bracket for Key Locks is installed,
it's possible to fix a valve open or shut.

Seal Kit

You can buy a Seal Kit at the valve maintenance time.

Valve Series	Kit Contents
VUBV-915 Series (2-way Type)	<ul style="list-style-type: none"> • INSTRUCTION MANUAL • Ball • STEM BEARING • O-RING(1), O-RING(2)
VUBV-115 Series (2-way Type)	<ul style="list-style-type: none"> • SEAT ASSEMBLY (SEAT + SEAT CARRIERS) • DISC SPRING • END SCREW SEALS • LUBRICANT • SDS of LUBRICANT

Features

1. Compact, maximum-flow design
2. Low operating torque
3. Flow Pattern: 2-way Type, 3-way Type
4. Panel mountable

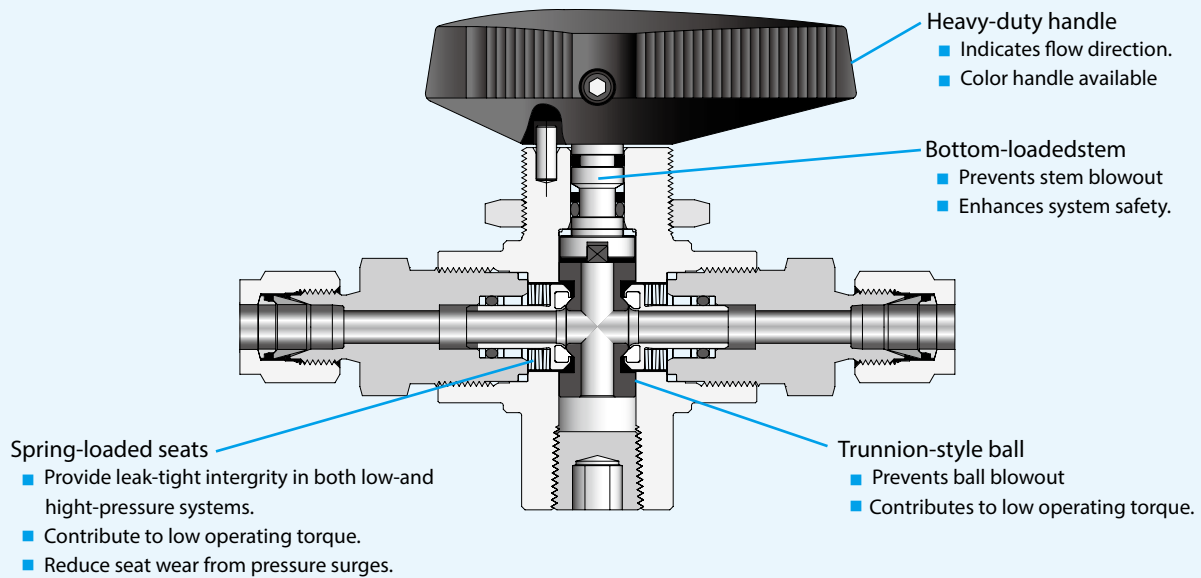

Important Information About Ball Valves

1. **Fujikin** ball valves are designed to be used in a fully open or fully closed position.
2. Valves that have not been cycled for a period of time may have a higher initial actuation torque.

Technical Data

Working Pressure, Temperature Rating

Types	Seat Material	Temperature Rating °F (°C)	Pressure Rating psig (bar)
VUBV -941 Series	PEEK	0 to 450 (-17 to 232)	6000 (413)
VUBV (T)-968 Series			6600 to 10000 (454 to 689) depending on end connection

Temperature and Pressure Rating

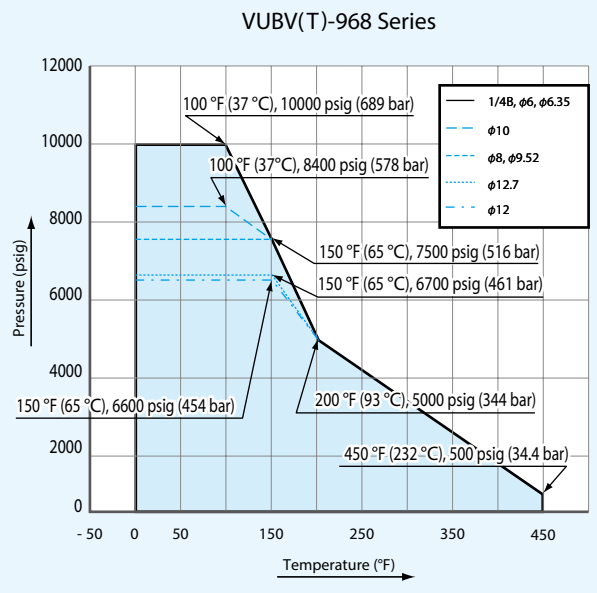
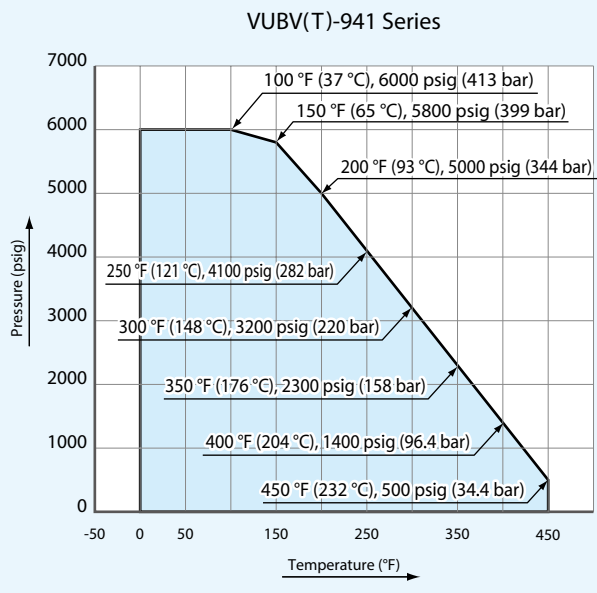

Note: Please contact Fujikin beforehand if you are planning to use these valves at lower temperature than 32 °F (0°C).

Applicable Fluid

Air, Nitrogeh gas, Inert gas like Helium, and non-corrosive gas and liquid.

Materials of Construction

VUBV-941 Series

2-way Type

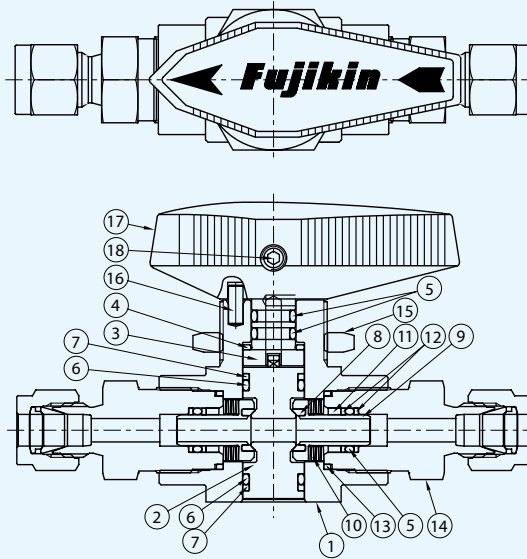

No.	Description	Materials
1	BODY ※	ASTM A479 316
2	BALL ※1 ※	ASTM A276 316
3	STEM	ASTM A276 316
4	STEM BEARING	C-PTFE
5	O-RINGS(1) ※	FKM
6	O-RINGS(2) ※	FKM
7	BACKUP RINGS	C-PTFE
8	SEATS ※	PEEK
9	SEAT CARRIERS ※	ASTM A276 316
10	DISC SPRINGS ※	ALLOY X-750
11	SEAT CARRIER GUIDES ※	ASTM A276 316
12	SEAT CARRIER BACKUP RINGS ※	C-PTFE
13	END SCREW SEALS ※	PTFE
14	END SCREWS ※	ASTM A479 316
15	PANEL NUT	ASTM A276 304 or ASTM A276 316
16	STOP PIN	SUS304
17	HANDLE	PHENOLIC RESIN + C3604B
18	SET SCREW	S17400 or SUS630

※ : Wetted part

※1 : Ball trunnions are PTFE coated.

Materials of Construction

VUBV,VUBVT-968 Sereis

2-way Type

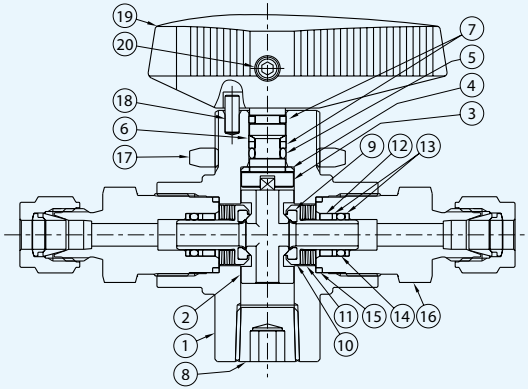

3-way Type

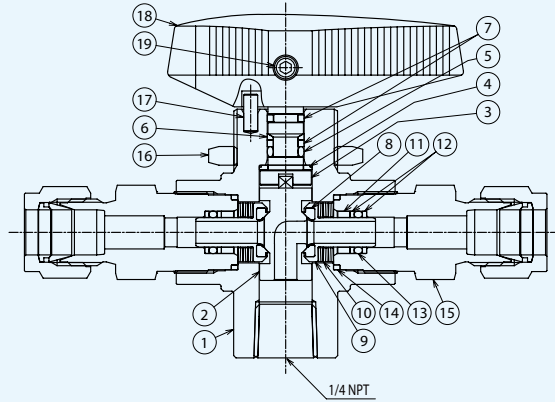

No.	Description	Materials
1	BODY ※1	ASTM A479 316
2	BALL ※1 ※2	ASTM A276 316
3	STEM	ASTM A276 316
4	STEM BEARING	PEEK
5	STEM O-RING ※1	FKM
6	STEM BACKUP RING1	PEEK
7	STEM BACKUP RING2	PTFE
8	PLUG ※1	ASTM A479 316
9	SEATS ※1	PEEK
10	SEAT CARRIERS ※1	ASTM A276 316
11	DISC SPRINGS ※1	ALLOY X-750
12	SEAT CARRIER GUIDES ※1	ASTM A276 316
13	SEAT CARRIER BACKUP RINGS ※1	C-PTFE
14	SEAT CARRIER O-RINGS ※1	FKM
15	END SCREW SEALS ※1	PTFE
16	END SCREWS ※1	ASTM A479 316
17	PANEL NUT	ASTM A276 304 or ASTM A276 316
18	STOP PIN	SUS304
19	HANDLE	PHENOLIC RESIN + C3604B
20	SET SCREW	S17400 or SUS630

No.	Description	Materials
1	BODY ※1	ASTM A479 316
2	BALL ※1 ※2	ASTM A276 316
3	STEM	ASTM A276 316
4	STEM BEARING	PEEK
5	STEM O-RING ※1	FKM
6	STEM BACKUP RING1	PEEK
7	STEM BACKUP RING2	PTFE
8	SEATS ※1	PEEK
9	SEAT CARRIERS ※1	ASTM A276 316
10	DISC SPRINGS ※1	ALLOY X-750
11	SEAT CARRIER GUIDES ※1	ASTM A276 316
12	SEAT CARRIER BACKUP RINGS ※1	C-PTFE
13	SEAT CARRIER O-RINGS ※1	FKM
14	END SCREW SEALS ※1	PTFE
15	END SCREWS ※1	ASTM A479 316
16	PANEL NUT	ASTM A276 304 or ASTM A276 316
17	STOP PIN	SUS304
18	HANDLE	PHENOLIC RESIN + C3604B
19	SET SCREW	S17400 or SUS630

※1 : Wetted part

※2 : Ball trunnions are PTFE coated.

※1 : Wetted part

※2 : Ball trunnions are PTFE coated.

About a BALL shape

There is no No.8 PLUG when being 2-way Type, and it's different shape of No.2 BALL in 3-way Type.

2-way Type Ball

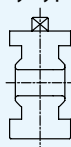

3-way Type Ball

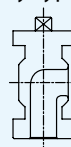

Ordering Information and Dimensions

1. Dimensions, in inches (millimeters), are for reference only and are subject to change.
2. Dimensions shown with **V-Lok** tube fitting nuts finger-tight.

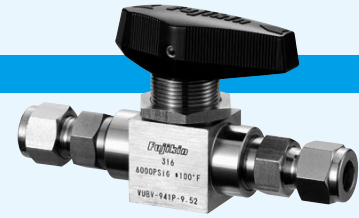

VUBV-141, 941 Type

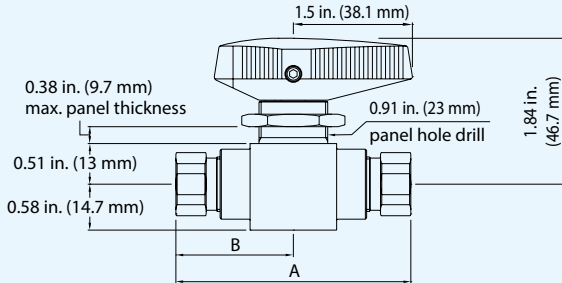

VUBV, VUBVT-168, 968 Type

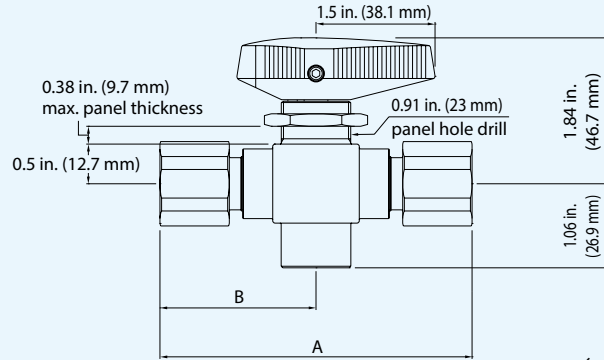

(Unit: mm)

Flow Pattern	Connection	Nominal Dia. Inch (mm)	Orifice Dia. Inch (mm)	Dimensions Inch (mm)		Ordering Numbers			
				A	B				
2-way Type	V-Lok	1/4 (6.35)	4.8	4.13 (105)	2.07 (52.6)	VUBV-941P-6.35	VUBV-968P-6.35		
		3/8 (9.52)		4.41 (112)	2.19 (55.6)	VUBV-941P-9.52	VUBV-968P-9.52		
		1/2 (12.7)		4.61 (117)	2.3 (58.4)	VUBV-941P-12.7	VUBV-968P-12.7		
		- (6)		4.13 (105)	2.07 (52.6)	VUBV-941P-6	VUBV-968P-6		
		- (8)		-	-	VUBV-941P-8	VUBV-968P-8		
		- (10)		4.41 (112)	2.2 (55.9)	VUBV-941P-10	VUBV-968P-10		
		- (12)		4.61 (117)	2.3 (58.4)	VUBV-941P-12	VUBV-968P-12		
		Female NPT		1/4	2.94 (74.7)	1.47 (37.3)	VUBV-141PBN	-	
	3-way Type	V-Lok		6.35 (-)	4.13 (105)	2.07 (52.6)	-	VUBVT-968P-6.35	※
				9.52 (-)	4.41 (112)	2.19 (55.6)	-	VUBVT-968P-9.52	※
12.7 (-)			4.61 (117)	2.3 (58.4)	-	VUBVT-968P-12.7	※		
- (6)			4.13 (105)	2.07 (52.6)	-	VUBVT-968P-6	※		
- (8)			-	-	-	VUBVT-968P-8	※		
- (10)			4.41 (112)	2.2 (55.9)	-	VUBVT-968P-10	※		
- (12)			4.61 (117)	2.3 (58.4)	-	VUBVT-968P-12	※		
Female NPT			1/4	3.93 (99.8)	1.97 (50)	-	VUBVT-168PBN	※	

※ : Bottom port of all 3-way type valves are 1/4 Female NPT.

※ : Getting ready. Begin to sell it soon.

Ordering Information

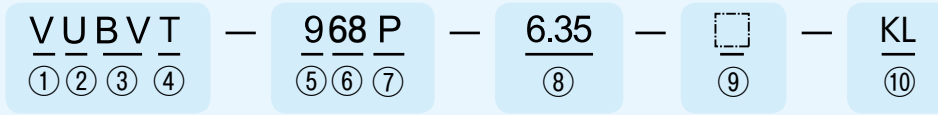

- | | | | |
|---|---|--|---|
| ① Valve Series | ⑤ End Connections
1 : Thread Type
9 : V-Lok Type | ⑧ Connection Sizes
6.35 : V-Lok 1/4
9.52 : V-Lok 3/8
12.7 : V-Lok 1/2
6 : V-Lok 6
8 : V-Lok 8
10 : V-Lok 10
12 : V-Lok 12
BN : Female NPT 1/4 in. | ⑨ Handle Color
Blank : Black
B : Blue
G : Green
YR : Orange
RE : Red
Y : Yellow |
| ② Body Material
Stainless Steel | ⑥ Working Pressure
68 : 10000 psi (689 bar) | | ⑩ Key Lock Type
Blank : without Key Lock
KL : with Key Lock |
| ③ Valve Type
Ball Valves | ⑦ Panel Nut | | |
| ④ Flow Patern
Blank : 2-way Type
T : 3-way Type | | | |

Option

HANDLE COLOR

Standard Handle Color is black.

When you ordered a colored handle besides the black. Please put the relevant symbol to the part number end from beside table.

Ex. Ordering Number in case of you will order blue handle
VUBV-941P-6.35-B

HANDLE Color	The end of Ordering Number
Black	—
Blue	-B
Green	-G
Orange	-YR
Red	-RE
Yellow	-Y

Key Lock & Bracket

- Locking with standard parts for lock , and with a handle of flow direction locking certainly at open or close for 2-way valves
- Possible to fix a locking part on the hole in the bracket or install a distinction tag.
- After installing to a panel, it isn't possible to install a bracket.

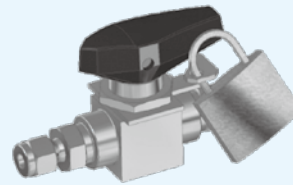

Seal Kit

You can buy a Seal Kit at the valve maintenance time.

Valve Series	Kit Contents
VUBV-941 Series (2-way Type)	<ul style="list-style-type: none"> • INSTRUCTION MANUAL • BALL • STEM BEARING • O-RING(1), O-RING(2) • SEAT ASSEMBLY (SEAT + SEAT CARRIERS) • DISC SPRING • END SCREW SEALS • LUBRICANT • SDS of LUBRICANT
VUBV-968 Series (2-way Type)	<ul style="list-style-type: none"> • INSTRUCTION MANUAL • BALL • STEM • STEM BEARING • STEM O-RING • SEAT ASSEMBLY (SEAT + SEAT CARRIERS) • DISC SPRING • END SCREW SEALS • LUBRICANT • SDS of LUBRICANT
VUBVT-968 Series (3-way Type)	<ul style="list-style-type: none"> • INSTRUCTION MANUAL • BALL • STEM • STEM BEARING • STEM O-RING • STEM BACKUP RING1, 2 • SEAT ASSEMBLY (SEAT + SEAT CARRIERS) • DISC SPRING • END SCREW SEALS • LUBRICANT • SDS of LUBRICANT

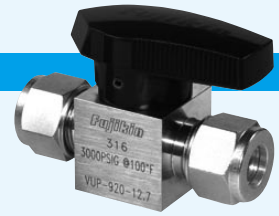

Features

1. Simple, Compact Design
2. Low Operating Torque
3. Quarter Turn Operation

Technical Data

Temperature and Pressure Rating

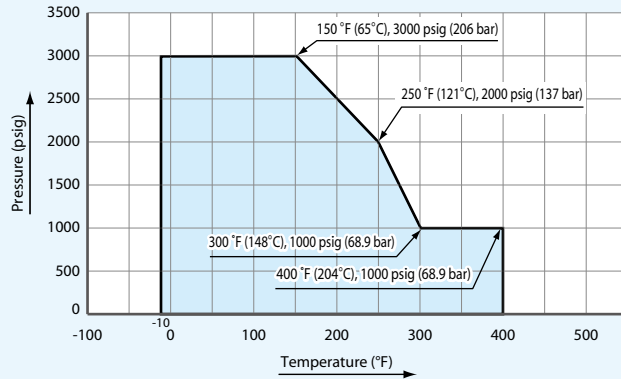

Applicable Fluid

Air, Nitrogen gas, Inert gas like Helium, and non-corrosive gas and liquid.

Attention

1. Differential pressure is limited to 150 psig (10.3 bar) maximum if reverse-flow occurs.
2. Reverse-flow throttling may damage O-Ring.

Materials of Construction

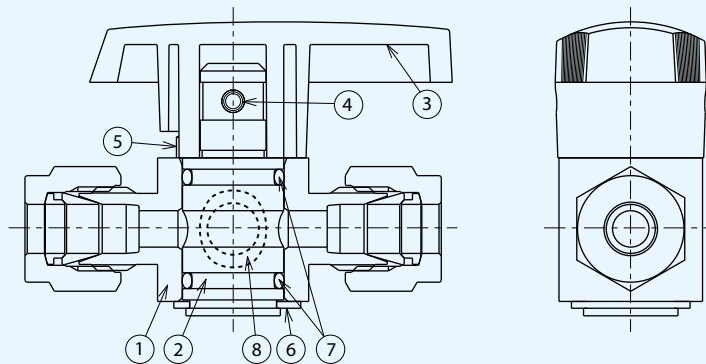

No.	Description	Materials
1	BODY ※ 1	ASTM A479 316
2	PLUG ※ 1	PTFE-Coated ASTM A479 316
3	HANDLE	POLYETHERIMIDE
4	ROLL SPRING PIN	SUS304
5	STOP PIN	SUS304
6	C-RING	SUS304
7	O-RING ※ 1, ※ 2	PTFE-Coated FKM
8	O-RING ※ 1	Silicone-based
Lubricants		Silicone-based

※ 1 : Wetted parts

※ 2 : Please refer to the maintenance stock number of parts of P129 in case of ordering No.7 or 8 parts element.

Operation

Open



Forward-Flow Throttling



Closed

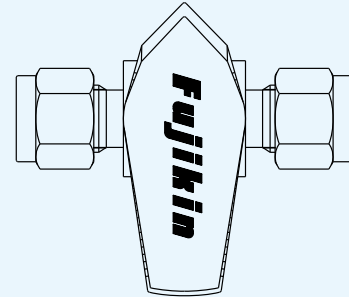

Dimensions

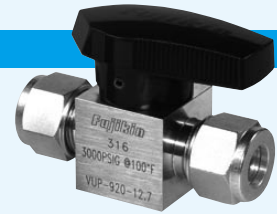
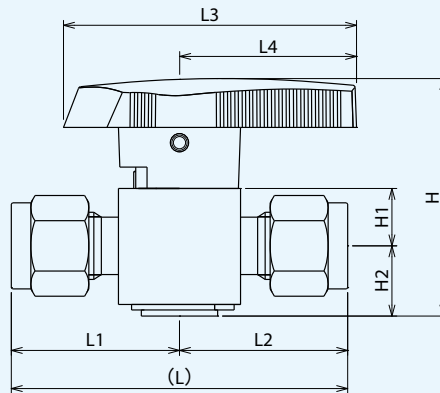

End Connections	Nominal Sizes	Working Pressure psig (bar)	Orifice in. (mm)	Dimensions in. (mm)									Ordering Numbers
				L	L1	L2	H	H1	H2	L3	L4	W	
V-Lok	1/4 in.	3000 (206)	0.173 (4.4)	2.17 (55.1)	1.08 (27.6)	1.54 (39.1)	0.37 (9.4)	0.46 (11.7)	1.89 (48)	1.14 (29)	0.75 (19.1)	VUP-920-6.35	
	2.29 (58.2)			1.15 (29.1)	VUP-920-9.52-S								
	3/8 in.		0.283 (7.2)	2.66 (67.6)	1.33 (33.8)	2.14 (54.4)	0.56 (14.2)	0.66 (16.8)	2.47 (62.7)	1.5 (38.1)	1.12 (28.4)	VUP-920-9.52	
2.88 (73.2)				1.44 (36.6)	VUP-920-12.7								
Female NPT	1/4 in.		0.173 (4.4)	2.09 (53.1)	1.05 (26.6)	1.54 (39.1)	0.37 (9.4)	0.46 (11.7)	1.89 (48)	1.14 (29)	0.75 (19.1)	VUP-120BN	
	1/2 in.			2.88 (73.2)	1.44 (36.6)							2.14 (54.4)	0.56 (14.2)
Rc	1/4	0.173 (4.4)	2.21 (56.1)	1.1 (28.1)	1.54 (39.1)	0.37 (9.4)	0.46 (11.7)	1.89 (48)	1.14 (29)	0.75 (19.1)	VUP-120B		
	1/2		3.14 (79.8)	1.57 (39.9)							2.14 (54.4)	0.56 (14.2)	0.66 (16.8)

Ordering Information

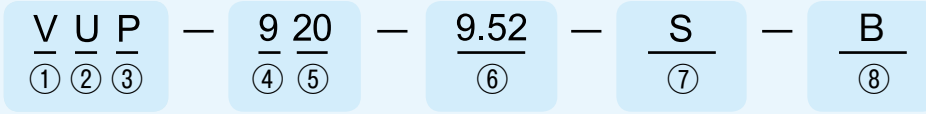

① Valve Series

② Body Material
Stainless Steel

③ Valve Type
Plug Valves

④ End Connections
1: Thread Type
9: **V-Lok** Type

⑤ Working Pressure
3000 psig (206 bar)

⑥ Connection Sizes
6.35: **V-Lok** 1/4 in.
9.52: **V-Lok** 3/8 in.
12.7: **V-Lok** 1/2 in.
BN: 1/4 NPT
DN: 1/2 NPT
B: Rc1/4
D: Rc1/2

⑦ Body Sizes
BLANK: STD
S: Small Size

⑧ Handle Color
Blank: Green
B: Blue ※
BK: Black ※
RE: Red ※
Y: Yellow ※
YR: Orange ※

Attention
The handle color change after shipment can't be available. Please order the Plug Valves with color handle when you need.

※ : Getting ready. Begin to sell it soon.

Maintenance Parts (O-Rings) Ordering Numbers

Orifice Diameter in. (mm)	Valve Ordering Numbers	O-Ring Ordering Numbers
0.173 (4.4)	VUP-920-6.35	GT O-Ring VUP-920-6.35
	VUP-920-9.52-S	
	VUP-120BN	
	VUP-120B	
0.283 (7.2)	VUP-920-9.52	GT O-Ring VUP-920-9.52
	VUP-920-12.7	
	VUP-120-DN	
	VUP-120D	

Please refer the procedure on the instruction manual (No. TKS01-120910-01) before deassembling and checking it.

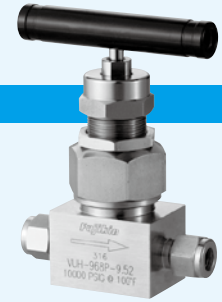

Features

1. Panel Mountable
2. Nonrotating Ball Stem Tip
3. Regulating Stem Tip Available
4. End Connections **V-Lok** Tube Fittings

Technical Data

Temperature and Pressure Rating

VUH-941 Series PTFE Packing Type

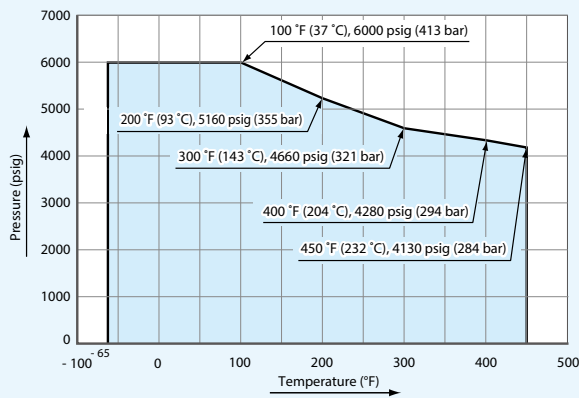

VUH-968 Series PTFE Packing Type

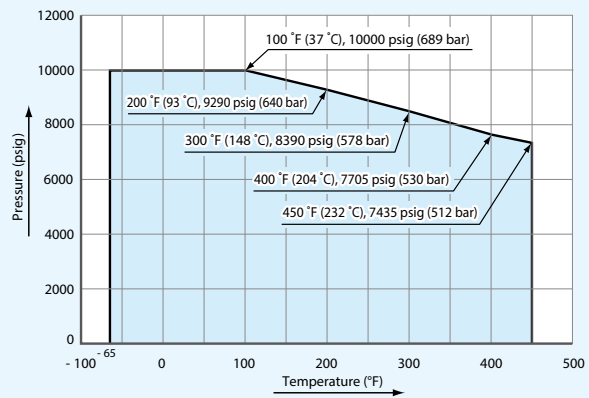

VUH-941 Series Grafoil Packing Type

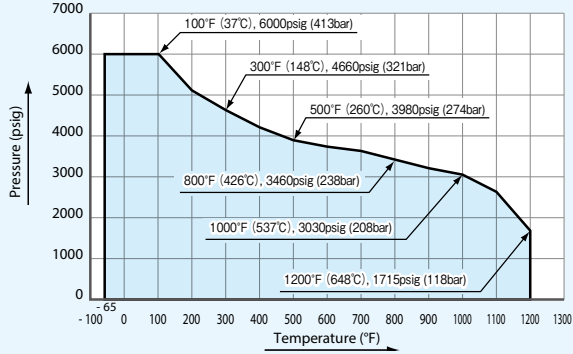

VUH-968 Series Grafoil Packing Type

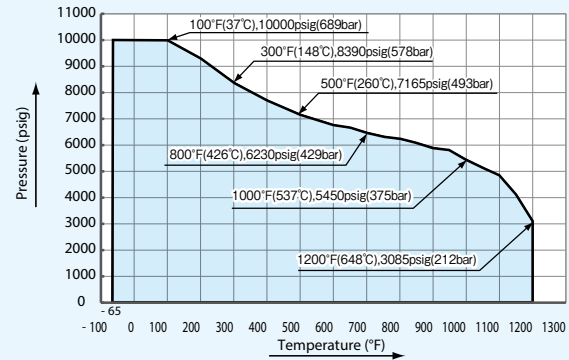

Applicable Fluid

Air, Nitrogen gas, Inert gas like Helium, and non-corrosive gas and liquid.

Material of Construction

VUH-941 Series

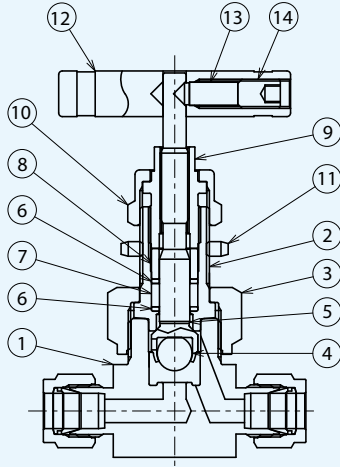

No.	Description	Materials
1	BODY	※ ASTM A479 316
2	BONNET	※ ASTM A479 316
3	BONNET NUT	ASTM A276 316
4	BALL TIP	※ ASTM A276 316
5	STEM	※ ASTM A276 316
6	PACKING SUPPORT	※ C-PTFE
7	PACKING	※ PTFE
8	GLAND	ASTM A276 316
9	PACKING BOLT	ASTM A276 316
10	LOCK NUT	ASTM A276 316
11	PANEL NUT	ASTM A276 304 or ASTM A276 316
12	HANDLE	A6061B
13	PIN	SUS316
14	SET SCREW	SUSXM7

※ : Wetted part

VUH-968 Series

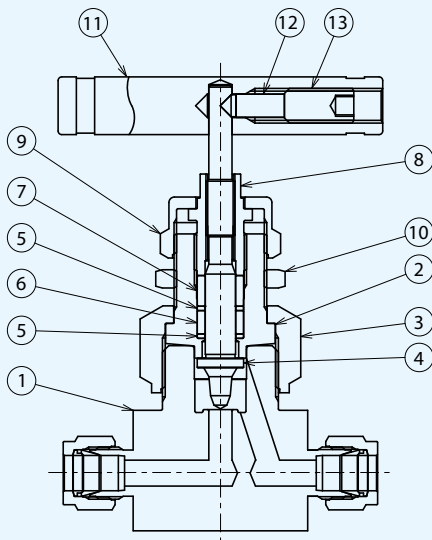

No.	Description	Materials
1	BODY	※ ASTM A479 316
2	BONNET	※ ASTM A479 316
3	BONNET NUT	ASTM A276 316
4	STEM	※ ASTM A276 316
5	PACKING SUPPORT	※ C-PTFE
6	PACKING	※ PTFE
7	GLAND	ASTM A276 316
8	PACKING BOLT	ASTM A276 316
9	LOCK NUT	ASTM A276 316
10	PANEL NUT	ASTM A276 304 or ASTM A276 316
11	HANDLE	A6061B
12	PIN	SUS316
13	SET SCREW	SUSXM7

※ : Wetted part

Stem Types

VUH-941 Series

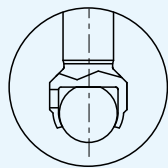

Nonrotating Stem Tip

VUH-968 Series

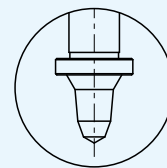

Regulating Stem Tip

Dimensions

VUH-941 Series

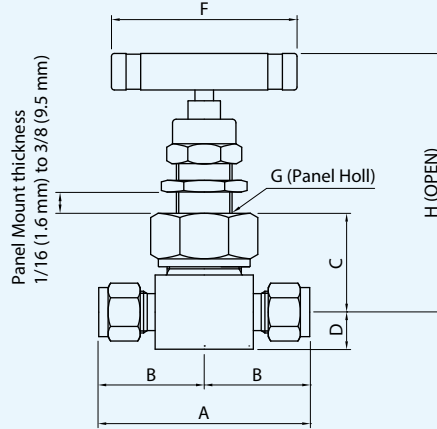

Connection Types	Nominal Diameter inch (mm)	Operating Pressure psi (bar)	Orifice inch (mm)	Dimensions inch (mm)							Ordering Numbers	
				A	B	C	D	F	G	H		
V-Lok	1/4 (6.35)	6000 (413)	0.16 (4)	2.4 (61)	1.2 (30.5)	1.09 (27.7)	0.38 (9.7)	1.75 (44.4)	0.59 (15.1)	3.04 (77.2)	VUH-941P-6.35	
	3/8 (9.52)		0.25 (6.4)	2.83 (71.9)	1.41 (35.8)	1.34 (34)	0.5 (12.7)	2.5 (63.5)	0.78 (19.8)	3.7 (94)	VUH-941P-9.52	
				3.04 (77.2)	1.52 (38.6)						VUH-941P-12.7-S	
1/2 (12.7)	0.44 (11.1)		3.92 (99.6)	1.96 (49.8)	1.82 (46.2)	0.62 (15.7)	3.5 (88.9)	1.03 (26.2)	4.76 (121)	VUH-941P-12.7		
Female NPT	1/4		0.16 (4)	2.06 (52.3)	1.03 (26.2)	1.09 (27.7)	0.39 (9.9)	1.75 (44.4)	0.59 (15.1)	3.04 (77.2)	VUH-141PBN	※
	3/8		0.25 (6.4)	2.25 (57.2)	1.12 (28.4)	1.34 (34)	0.5 (12.7)	2.5 (63.5)	0.78 (19.8)	3.7 (94)	VUH-141PCN	※
	1/2		0.44 (11.1)	3.12 (79.2)	1.56 (39.6)	1.82 (46.2)	0.62 (15.7)	3.5 (88.9)	1.03 (26.2)	4.76 (121)	VUH-141PDN	※
Rc	1/4		0.16 (4)	2.06 (52.3)	1.03 (26.2)	1.09 (27.7)	0.39 (9.9)	1.75 (44.4)	0.59 (15.1)	3.04 (77.2)	VUH-141PB	※
	3/8		0.25 (6.4)	2.25 (57.2)	1.12 (28.4)	1.34 (34)	0.5 (12.7)	2.5 (63.5)	0.78 (19.8)	3.7 (94)	VUH-141PC	※
	1/2	0.44 (11.1)	3.12 (79.2)	1.56 (39.6)	1.82 (46.2)	0.62 (15.7)	3.5 (88.9)	1.03 (26.2)	4.76 (121)	VUH-141PD	※	

※ : Getting ready. Begin to sell it soon.

VUH-968 Series

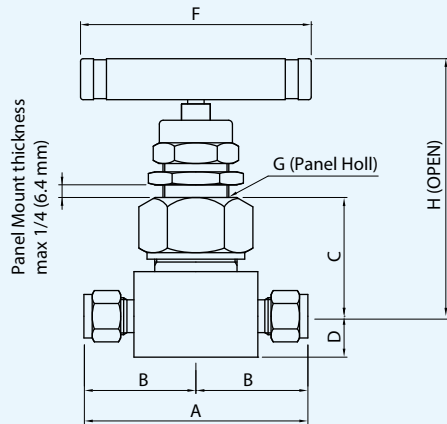

Connection Types	Nominal Diameter inch (mm)	Operating Pressure psi (bar)	Orifice inch (mm)	Dimensions inch (mm)							Ordering Numbers
				A	B	C	D	F	G	H	
V-Lok	1/4 (6.35)	10000 (689)	0.44 (11.1)	2.82 (71.6)	1.41 (35.8)	1.38 (35.1)	0.5 (12.7)	2.5 (63.5)	0.81 (20.6)	3.31 (84.1)	VUH-968P-6.35
	3/8 (9.52)		0.25 (6.4)	3.39 (86.1)	1.69 (43)	1.8 (45.8)	0.62 (15.8)	3.5 (88.9)	1.06 (26.9)	4.25 (108)	VUH-968P-9.52
Female NPT	1/4		0.44 (11.1)	2.25 (57.2)	1.13 (28.6)	1.38 (35.1)	0.5 (12.7)	2.5 (63.5)	0.81 (20.6)	3.31 (84.1)	VUH-168PBN ※
	3/8		0.25 (6.4)	3.25 (82.6)	1.63 (41.3)	1.94 (49.3)	0.78 (19.8)	3.5 (88.9)	1.06 (26.9)	4.25 (108)	VUH-168PCN ※
	1/2										VUH-168PDN ※
Rc	1/4		0.44 (11.1)	2.25 (57.2)	1.13 (28.6)	1.41 (35.8)	0.5 (12.7)	2.5 (63.5)	0.81 (20.6)	3.31 (84.1)	VUH-168PB ※
	3/8		0.25 (6.4)	3.25 (82.6)	1.63 (41.3)	1.94 (49.3)	0.78 (19.8)	3.5 (88.9)	1.06 (26.9)	4.25 (108)	VUH-168PC ※
	1/2										VUH-168PD ※

※ : Getting ready. Begin to sell it soon.

Ordering Information

VUH — 141P — BN — GR
 ① ② ③ ④ ⑤ ⑥ ⑦ ⑧

- | | | | |
|------------------------------------|---|--|---|
| ① Valve Series | ④ End Connection
1: Thread Type
9: V-Lok Type | ⑦ Connection Sizes
B: Rc1/4
C: Rc3/8
D: Rc1/2
BN: 1/4NPT
CN: 3/8NPT
DN: 1/2NPT
-6.35: V-Lok 1/4
-9.52: V-Lok 3/8
-12.7: V-Lok 1/2 | ⑧ Gland Packing materials
Blank: PTFE+C-PTFE
GR: Graphoil |
| ② Body Material
Stainless Steel | ⑤ Working Pressure
41: 6000 psi (413 bar)
68: 10000 psi (689 bar) | | |
| ③ Valve Type
Needle Valves | ⑥ Panel Mount Type | | |

Features

1. Integrate-type Body & Compact Design
2. Excellent Operability with Small Operating Torque
3. Panel Mount Type
4. Linear Flow Control
5. Available with Round Handle Type & Bar Handle Type
6. 2-Stem Design



Technical Data

Temperature and Pressure Rating

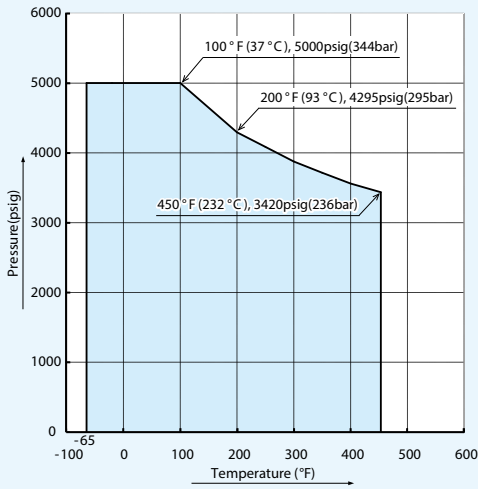

Flow Coefficient (Cv Value)

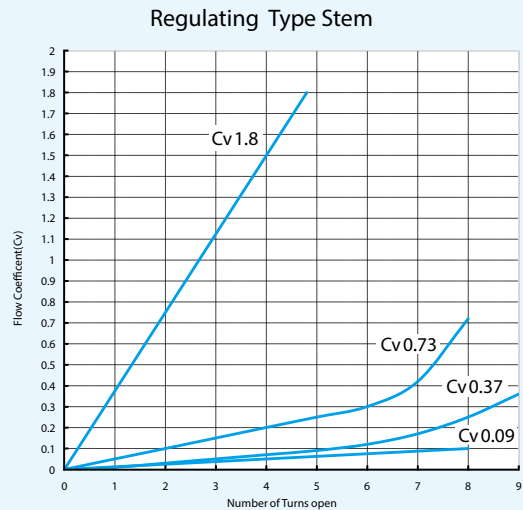
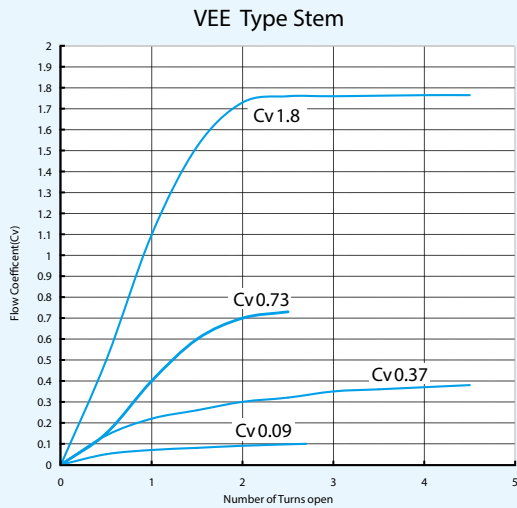

Applicable Fluid

Air, Nitrogen gas, Inert gas like Helium, and non - corrosive gas and liquid.

Material of Construction

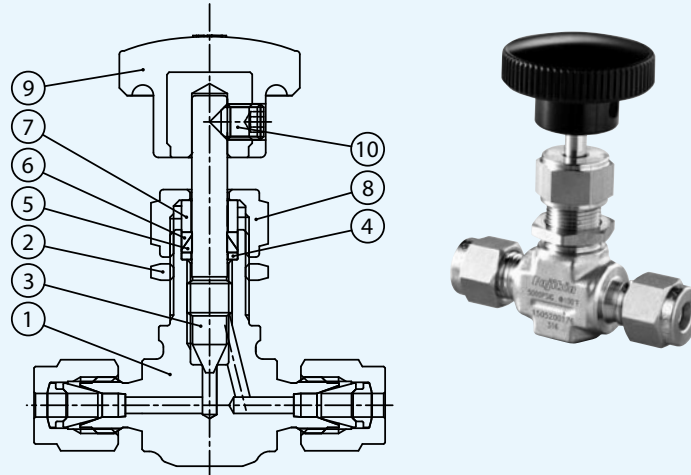

No.	Description	Material
1	BODY	※ ASTM A182 316
2	PANEL NUT	ASTM A276 316
3	STEM	VEE TYPE
		REGULATING TYPE
4	LOWER GLAND	※ ASTM A276 316
5	LOWER PACKING	※ PTFE
6	UPPER PACKING	※ PTFE
7	PACKING GLAND	ASTM A276 316
8	LOCK NUT	ASTM A276 316
9	HANDLE	Phenolic with brass insert
10	SET SCREW	316 SS

※ : Wetted Parts

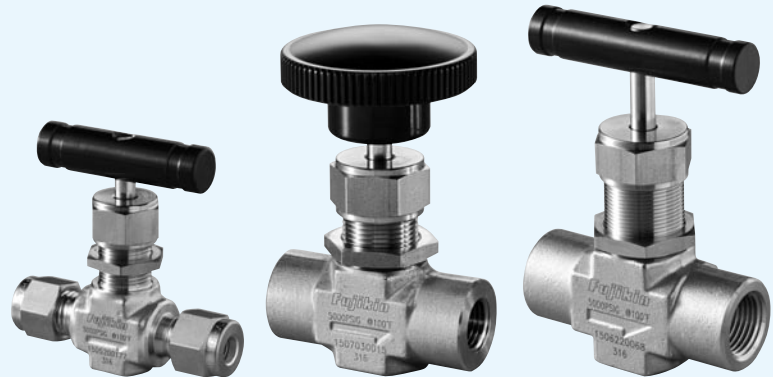

V-Series Integral-Bonnet Needle Stop Valves

V-Series Integral-Bonnet Needle Stop Valves

Dimensions

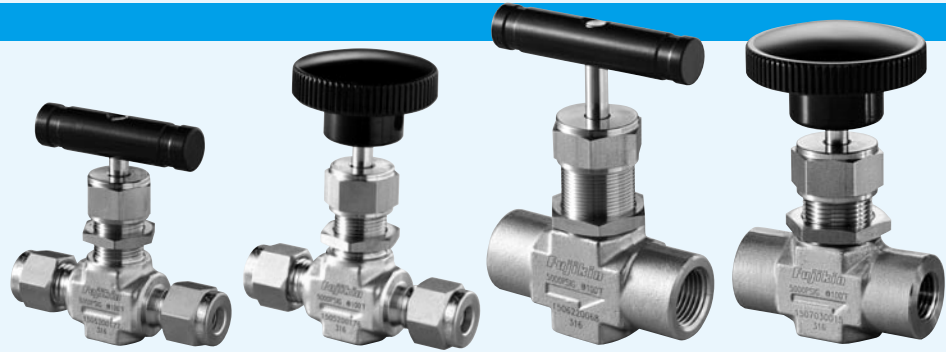

Globe Type

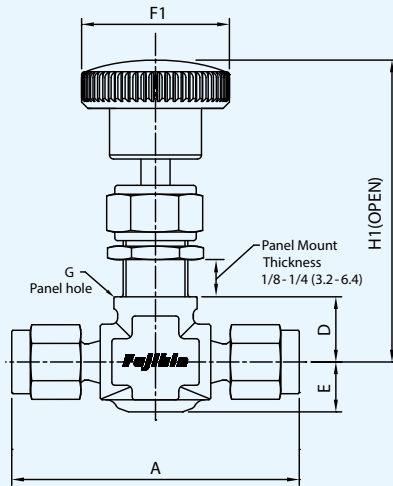

Angle Type

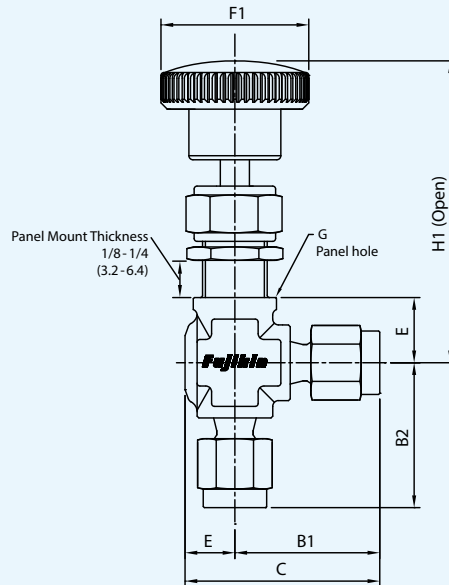

Bar Handle Type

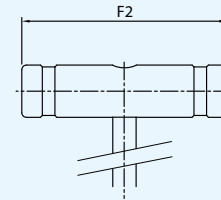

End Connections	Nominal Sizes inch (mm)	Working Pressure psig(bar)	Orifice inch (mm)	Dimensions inch (mm)										Ordering Numbers									
				Cv	A	B1	B2	C	D	E	F1	F2	G		H1	H2							
V-Lok	1/8 (3.2)	5000 (344)	0.079 (2)	0.09	1.94(49.3)	0.98 (24.9)	1.29 (32.8)	0.44 (11.2)	0.31 (7.9)	1 (25.4)	1.73 (44)	0.47 (11.9)	2.28 (57.9)	1.91 (48.4)	VUH-934P-3.2								
	- (3)				2.27(57.6)																	VUH-934P-3 ※	
Female NPT	1/8 (-)					1.88(47.8)	0.94(23.9)	1.25(31.8)								VUH-134PAN-5 ※							
	1/4 (6.35)					2.27(57.6)	1.13 (28.7)	1.51 (38.4)								VUH-934P-6.35 ※							
V-Lok	- (6)			0.173 (4.4)	0.37	2.34(59.4)	1.17(29.7)	1.54(39.1)		0.38 (9.7)	1.38 (35.1)	1.73 (44)	0.53 (13.5)	2.5 (63.5)	2.02 (51.4)	VUH-934P-6 ※							
	- (8)		2.34(59.4)			1.17(29.7)	1.54(39.1)														VUH-934P-8 ※		
Female NPT	1/8 (-)					1.62(41.1)	0.81(20.6)	1.19(30.2)								VUH-134PAN ※							
	3/8 (9.52)					2.58(65.5)	1.29(32.8)	1.79 (45.5)								VUH-934P-9.52 ※							
V-Lok	1/2 (12.7)			0.252 (6.4)	0.73	2.8(71.1)	1.4(35.6)	1.8(45.7)	0.55 (14)	0.5 (12.7)	1.88 (47.8)	2.52 (64)	0.78 (19.8)	2.97 (75.4)	2.43 (61.7)	VUH-934P-12.7-5 ※							
	- (10)		2.6(66)			1.3(33)	1.8(45.7)															VUH-934P-10 ※	
	- (12)		2.8(71.1)			1.4(35.6)	1.9(48.3)																VUH-934P-12-5 ※
	1/4 (-)		2.12(53.8)			1.06(26.9)	1.56(39.6)																VUH-134PBN ※
V-Lok	1/2 (12.7)		0.374 (9.5)	1.8	3.8 (96.5)	1.9 (48.3)	2.65 (67.3)	0.75 (19.1)	-	3 (76.2)	1.03 (26.2)	3.91 (99.3)	3.83 (97.4)	VUH-934P-12.7-BH ※									
	3/4 (19.05)																			VUH-934P-19.05-BH ※			
	- (12)																				VUH-934P-12-BH ※		
	- (18)																				VUH-934P-18-BH ※		
Female NPT	3/8 (-)				3 (76.2)	1.5 (38.1)	2.25 (57.2)					3.88 (98.6)		VUH-134PCN-BH ※									
	1/2 (-)													VUH-134PDN-BH ※									

※ : Getting ready. Begin to sell it soon.

Ordering Information

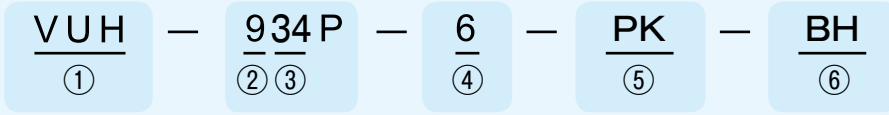

① Valve Series

- VUH : VEE Type Stem
- VUN : Regulating Type Stem ※
- (VUD : Soft Seat Type Stem) ※

② End Connection Types

- 0 : **V-Lok** Angle Type ※
- 1 : Thread Globe Type ※
- 3 : Thread Angle Type ※
- 9 : **V-Lok** Globe Type

③ Working Pressure

5000 psig (344 bar)

④ Connection Sizes

- 3.2 : **V-Lok** 1/8
- 6.35 : **V-Lok** 1/4
- 9.52 : **V-Lok** 3/8
- 12.7 : **V-Lok** 1/2
- 12.7-S : **V-Lok** 1/2 (Small Body Size Type)
- 19.05 : **V-Lok** 3/4
- 3 : **V-Lok** 3 ※
- 6 : **V-Lok** 6 ※
- 8 : **V-Lok** 8 ※
- 10 : **V-Lok** 10 ※
- 12 : **V-Lok** 12 ※
- 12-S : **V-Lok** 12 (Small Body Size Type) ※
- 18 : **V-Lok** 18

⑤ Packing Materials

- Blank : PTFE
- PK : PEEK ※
- PA : PFA ※
- PE : Polyethylene ※

⑥ Handle Types

- Blank : Round Handle Type ※
- BH : Bar Handle Type

When there are two kinds of Body Size to the same Connection Size, please add to ordering number of Small Type Body Size "-S" behind the character which shows the Connection Size.

Ex. 12-S, 12.7-S, AN-S

- AN : 1/8NPT ※
- AN-S : 1/8NPT (Small Body Size Type) ※
- BN : 1/4NPT ※
- CN : 3/8NPT ※
- DN : 1/2NPT ※

※ : Getting ready. Begin to sell it soon.

Brass Needle Stop Valves

With Color-coded Handles & Panel Mounting Nut

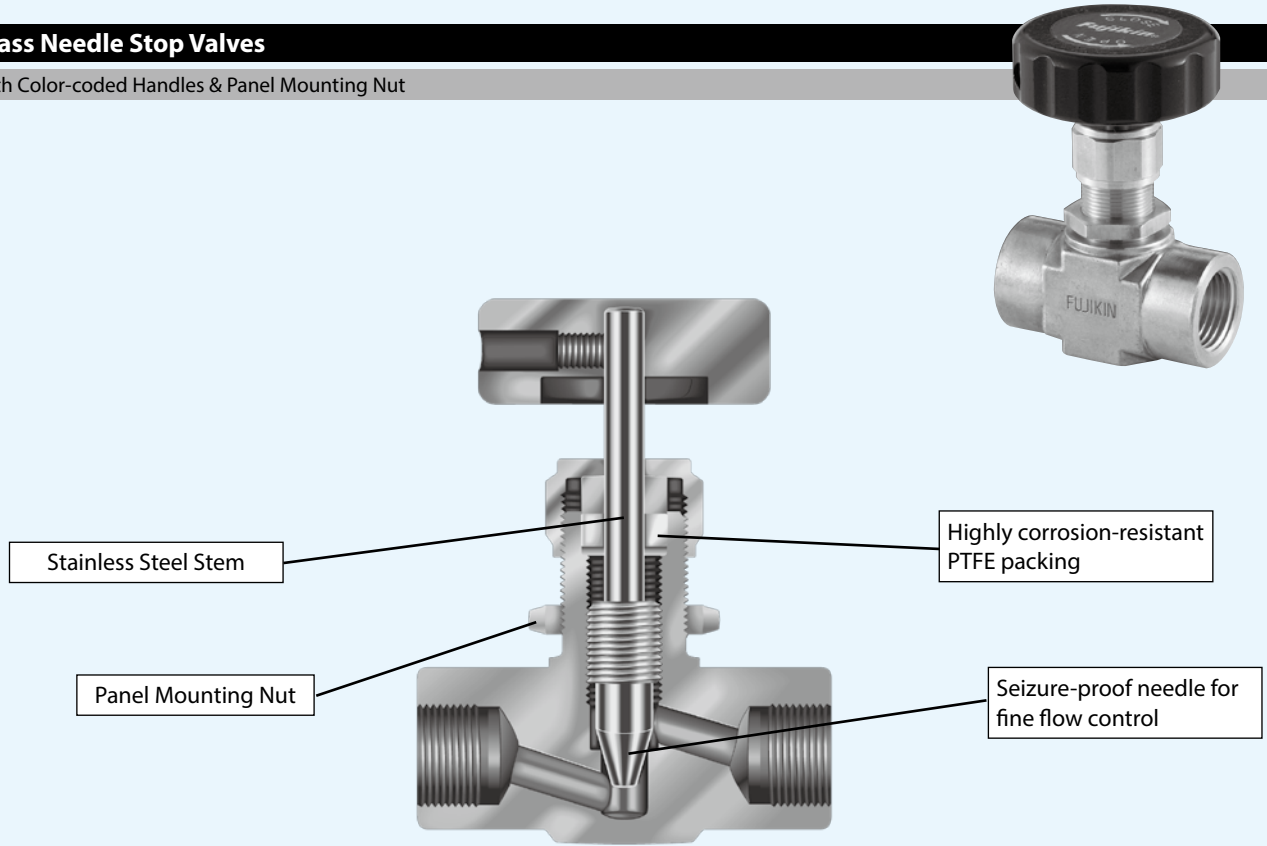

Features

1. Robust forged body and compact bonnet-less construction.
2. Needle design enhances ease of flow adjustment.
3. Packing and gland design reduce handle torque and enhance seal performance.

In the standard configuration, the valve comes with a black handle. blue, red, and green handles are also available.

※ It's popular for customers to use different colours for different fluids and flow lines.

Note: Materials and dimensions are subject to change without notice.

Ordering Number Designation

Threaded Connector Type

PDS-15B-SH-R

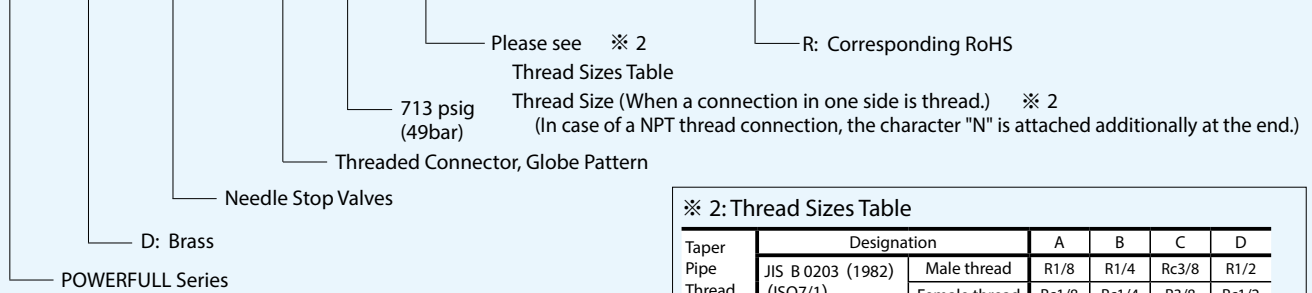

※ 2: Thread Sizes Table

Taper Pipe Thread	Designation		A	B	C	D
	JIS B 0203 (1982) (ISO7/1)	Male thread	R1/8	R1/4	Rc3/8	R1/2
	Female thread	Rc1/8	Rc1/4	R3/8	Rc1/2	

Thread designation complies with JIS B0203 (1982) (ISO7/1).
 Sizes as per JIS B0203 (1981) are shown for reference purpose.

Construction

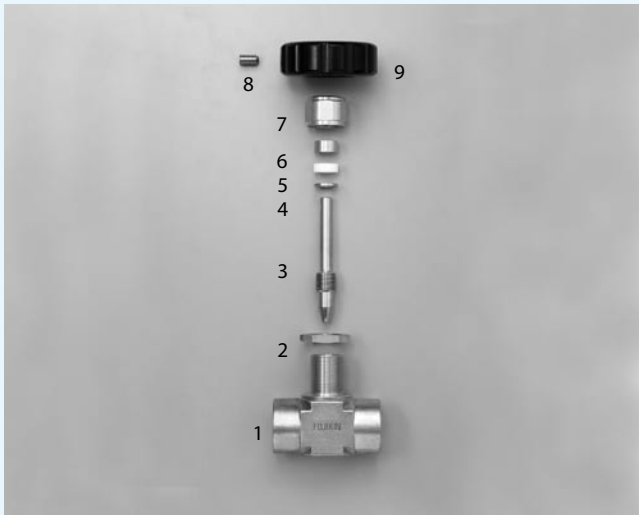

Materials

No.	Description	Materials
1	Body ※	C3771B
2	Panel Nut	C3604B
3	Stem ※	SUS303 or SUS316 ※ 1
4	Ring ※	SUS316
5	Gland Packing ※	P T F E
6	Gland	C3604B
7	Gland Nut	C3604B
8	Hexagon Socket Head Set Screw	SUS304 equivalent
9	Handwheel	A5056B ※ 2

※ : Wetted Parts

Exceptions:

1: Applicable fluid: Water, Air, Nitrogen gas, inter gas like Helium, and non-corrosive gas and liquid.

※ 1: SUS materials may use ASTM standard material(SUS equivalent material)

※ 2: Standard color of the Handwheel is black. A Nameplate (material: Tetoron) is stuck to the Handle.

A seat will be corroded on early by the Langerear index when you use a brass valve for tap water, **Fujikin** recommends use of a stainless steel valve.

Quoting : Japan Valve Manufacturer's Association Publication.

Brass 4.9 MPa POWERFULL SERIES Needle Stop Valves

Threaded Connector Type

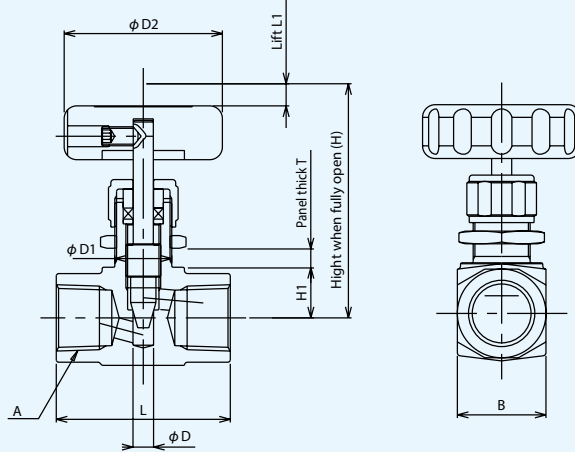

Individual drawings may be downloaded from the CAD Data Service section of the Fujikin website. http://www.fujikin.co.jp/fujikinhp_e/cad_s/

Dimension

UNIT(mm)

Nominal Dia. (B)	Orifice Dia. D	Face to face Dimension L	Connection Port A	Panel Mounting		H	L1	D2	B	T		Cv Value MAX.	Weight approx. (kg)	Ordering Numbers
				D1	H1					MIN.	MAX.			
1/8	5	40	Rc 1/8	13.2	10.5	55	4	40	18.5	2	6	0.3	0.2	PDS-15A-SH-R
1/4	6.5	45	Rc 1/4	18.5	14	71	6	50	21	2	8	0.55	0.3	PDS-15B-SH-R
3/8	6.5	50	Rc 3/8	18.5	16	73	6	50	28	2	8	0.7	0.4	PDS-15C-SH-R
1/2	6.5	55	Rc 1/2	18.5	16	73	6	50	28	2	8	0.9	0.4	PDS-15D-SH-R

Temperature-Pressure Curve

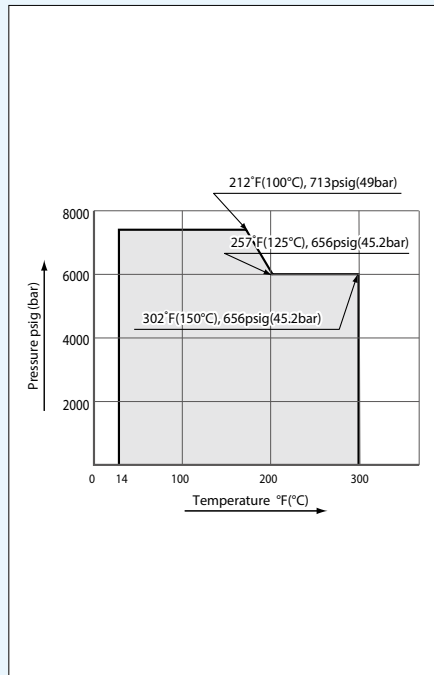

Cv Curves

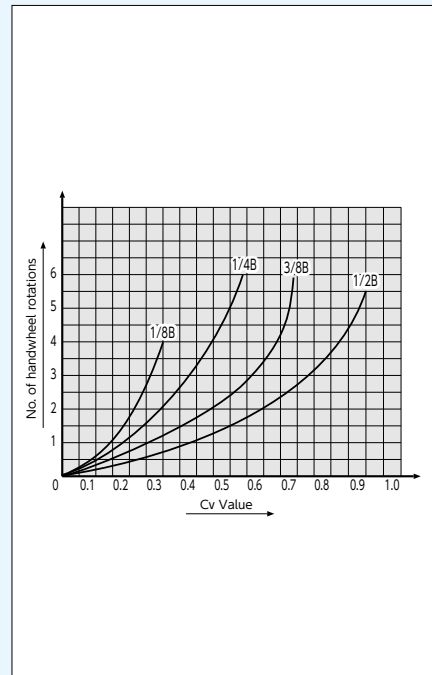

Specifications

Working Pressure psig (bar)	Temperature °F (°C)
713 (49) ※ 1, 2	14 - +302 (-10 - +150)

- ※ 1: Please refer to Temperature-Pressure Curve.
- ※ 2: Consult with **Fujikin** before using hydrogen, helium, or toxic gases, and in vacume state.

Exceptions:
Applicable fluid: Water, Air, Nitrogen gas, inter gas like Helium, and non-corrosive gas and liquid.

Panel Mounting Procedures

If you are panel-mounting the valve, follow these instructions:

1. Ensure that the bracket hole on the panel is \leq 0.5mm wider than the valve's Panel-Mounting Diameter (refer to the CAD drawing).
2. Use an adjustable wrench to loosen the Hex Nut securing the Handle. Remove the Handle.
3. Remove the Gland Nut and the Panel Nut.
4. Mount the valve on the panel and secure it with the Panel Nut. Reattach the Gland Nut and the Handle.
5. Tighten the Gland Nut with an adjustable wrench to the torque shown in the table below.

Gland Nut Tightening Torque (Reference Value)

Nominal Dia. (B)	Tightening Torque (N·m)
1/8	8
1/4	18
3/8	18
1/2	18

Note: Materials and dimensions are subject to change without notice.

Brass 2 MPa POWERFULL SERIES Miniature Valves with POWERFULLOK Fittings

Ordering Number Designation

P D W V P - 6 B - R

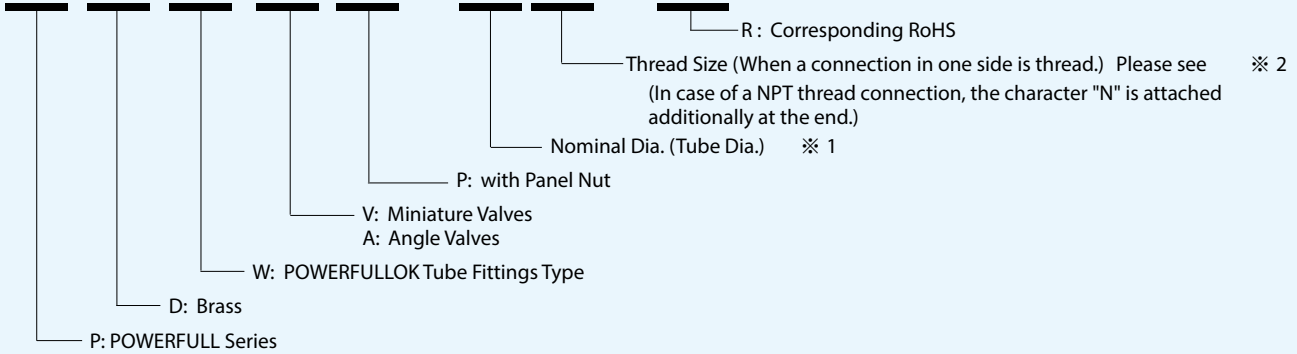

※ 1: Nominal Diameter (Tube Dia.)

	inch Sizes	mm Sizes
Nominal Diameter (Tube Dia.)	6.35 : connection part 6.35 9.52 : connection part 9.52 12.7 : connection part 12.7	6 : connection part 6 8 : connection part 8 10 : connection part 10 12 : connection part 12

※ 2: Thread Sizes Table

Taper Pipe Thread	Designation			
		A	B	C
JIS B 0203 (1982) (ISO7/1)	Male thread	R1/8	R1/4	Rc3/8
	Female thread	Rc1/8	Rc1/4	R3/8

Thread designation complies with JIS B0203 (1982) (ISO7/1).
Sizes as per JIS B0203 (1981) are shown for reference purpose.

Construction

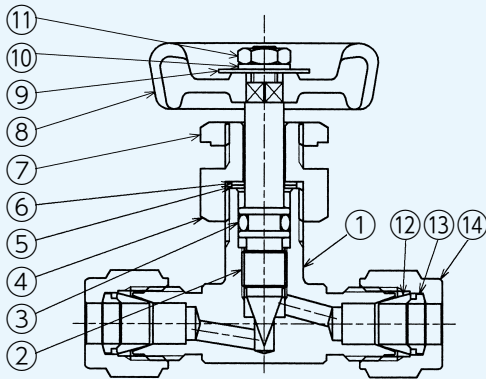

Materials

No.	Description	Materials
1	Body ※	C3771B
2	Stem	SUS304 or 303 ※3※4
3	O-Ring ※	NBR
4	Gland Nut	C3604B
5	Ring ※	A5052P
6	Sheet Packing	Nylon
7	Panel Nut	C3604B
8	Handle	ADC12
9	Name Plate	A5052P
10	Washer	SK85 (MF Ni)
11	Hex Nut	C3604B
12	Front Ring	C3602B
13	Back Ring	C3602B
14	Nut	C3604B

A seat will be corroded on early by the Langerear index when you use a brass valve for tap water, **Fujikin** recommends use of a stainless steel valve.
Quoting : Japan Valve Manufacturer's Association Publication.

※ : Wetted Part

Exceptions:

Applicable fluid: Water, Air, Nitrogen gas, inter gas like Helium, and non-corrosive gas and liquid.

※ 3: Stainless Steel : Nominal Dia. 9.52 or more,
C3604B : Rc Thread 3/8 or more

※ 4: SUS materials may use ASTM standard material(SUS equivalent material)

Brass 2 MPa POWERFULL SERIES Miniature Valves

POWERFULLOK Fittings Connection Type

Nom. Dia. 6, 6.35, 8 Type

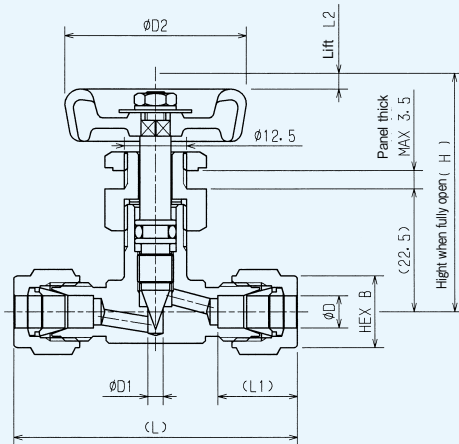

Nom. Dia. 9.52, 10, 12, 12.7 Type

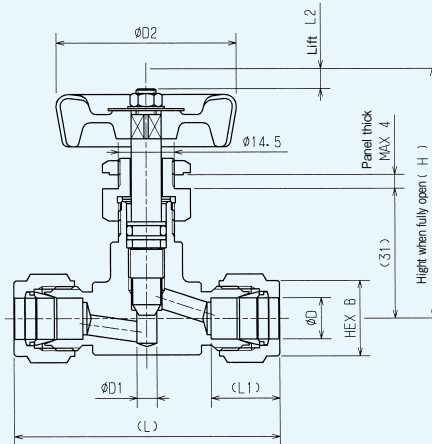

Individual drawings may be downloaded from the CAD Data Service section of the Fujikin website. http://www.fujikin.co.jp/fujikinhp_e/cad_s/

● Dimensions (inch size)

UNIT (mm)

Nominal Dia. D	D1	D2	L	L1	L2	B	H	Ordering Numbers
6.35	3	35	54.8	15.4	3	14	45	PDWVP-6.35-R
9.52	5	45	66.4	17.2	5	17	62	PDWVP-9.52-R
12.7	5	45	78.6	23	5	22	62	PDWVP-12.7-R

● Dimensions (mm size)

UNIT (mm)

Nominal Dia. D	D1	D2	L	L1	L2	B	H	Ordering Numbers
6	3	35	54.5	15.2	3	14	45	PDWVP-6-R
8	3	35	58.9	16.2	3	16	45	PDWVP-8-R
10	5	45	65.9	17	5	19	62	DWVP-10-R
12	5	45	77.6	22.5	5	22	62	PDWVP-12-R

About size distinction of the mm size and inch size

In order to distinguish easily from outside, edge of metric Nut is dented. Nut has size-marking.

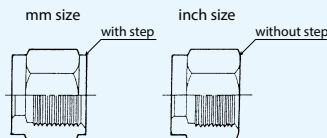

● Temperature-Pressure Curve

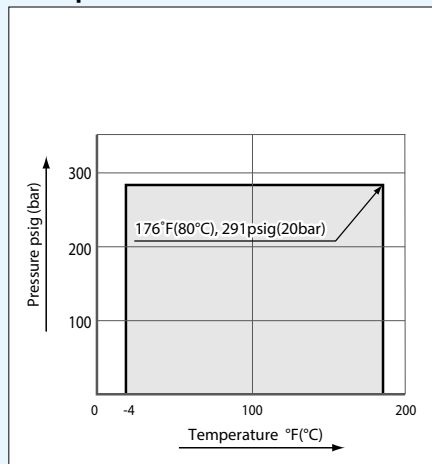

● Cv Curves

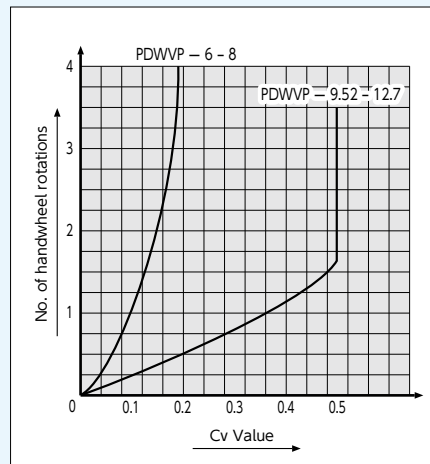

● Specifications

Working Pressure psig (bar)	Temperature °F (°C)
291 (20)	-4 ~ +176 (-20 ~ +80) ※

※ : Valves up to 392°F(200°C) are available.
Please contact **Fujikin** for more information.

Exceptions:
Applicable fluid: Water, Air, Nitrogen gas, inter gas like Helium, and non-corrosive gas and liquid.

Panel Mounting Procedures

If you are panel-mounting the valve, follow these instructions:

1. Ensure that the bracket hole on the panel is ≤ 0.5mm wider than the valve's Panel-Mounting Diameter (refer to the CAD drawing).
2. Use an adjustable wrench to loosen the Hex Nut securing the Handle. Remove the Handle.
3. Remove the Gland Nut and the Panel Nut.
4. Mount the valve on the panel and secure it with the Panel Nut. Reattach the Gland Nut and the Handle.
5. Please assemble the Handle at the end.

Note: Materials and dimensions are subject to change without notice.

Brass 2 MPa POWERFULL SERIES Miniature Valves

POWERFULLOK Fittings Connection Type

Nom. Dia. 6, 6.35, 8 Type

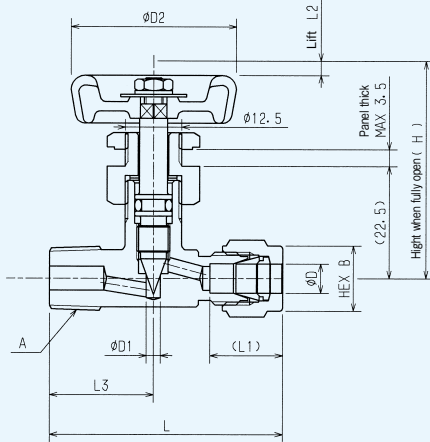

Nom. Dia. 9.52, 10, 12, 12.7 Type

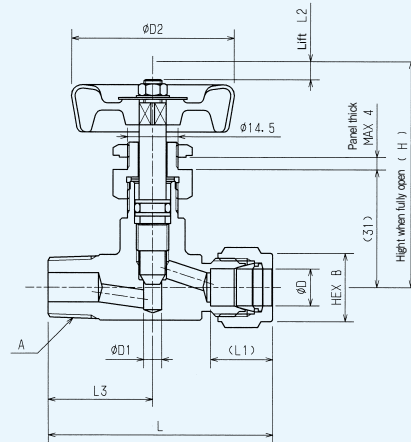

Individual drawings may be downloaded from the CAD Data Service section of the Fujikin website. http://www.fujikin.co.jp/fujikinhp_e/cad_s/

● Dimensions (inch size)

UNIT (mm)

Nominal Dia. D	A	D1	D2	L	L1	L2	L3	B	H	Ordering Numbers
6.35	R1/8	3	35	47.4	15.4	3	20	14	45	PDWVP-6.35A-R
6.35	R1/4	3	35	49.4	15.4	3	22	14	45	PDWVP-6.35B-R
9.52	R1/4	5	45	62.1	17.2	5	29	17	62	PDWVP-9.52B-R
9.52	R3/8	5	45	62.1	17.2	5	29	17	62	PDWVP-9.52C-R
12.7	R1/4	5	45	68.3	23	5	29	22	62	PDWVP-12.7B-R
12.7	R3/8	5	45	68.3	23	5	29	22	62	PDWVP-12.7C-R

● Dimensions (mm size)

UNIT (mm)

Nominal Dia. D	A	D1	D2	L	L1	L2	L3	B	H	Ordering Numbers
6	R1/8	3	35	47.2	15.2	3	20	14	45	PDWVP-6A-R
6	R1/4	3	35	49.2	15.2	3	22	14	45	PDWVP-6B-R
8	R1/8	3	35	49.5	16.2	3	20	16	45	PDWVP-8A-R
8	R1/4	3	35	51.5	16.2	3	22	16	45	PDWVP-8B-R
10	R1/4	5	45	61.9	17	5	29	19	62	PDWVP-10B-R
10	R3/8	5	45	61.9	17	5	29	19	62	PDWVP-10C-R
12	R1/4	5	45	67.8	22.5	5	29	22	62	PDWVP-12B-R
12	R3/8	5	45	67.8	22.5	5	29	22	62	PDWVP-12C-R

● Temperature-Pressure Curve

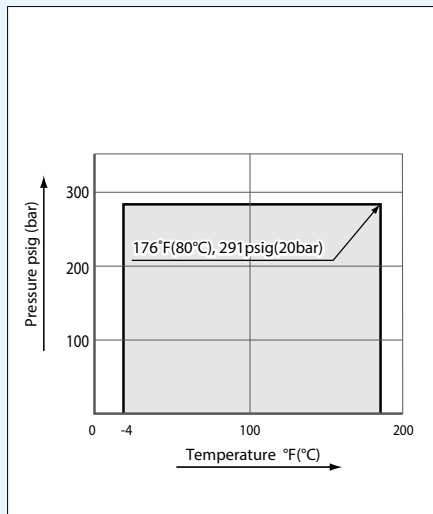

● Cv Curves

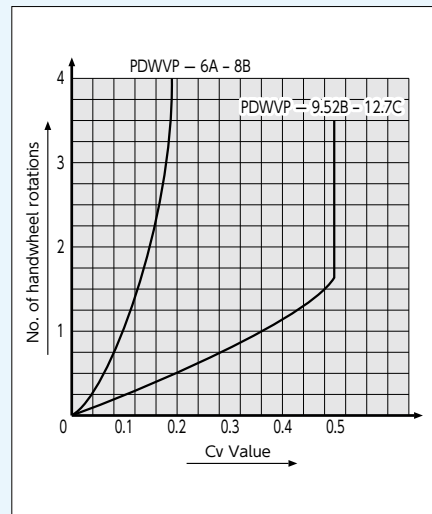

● Specifications

Working Pressure psig (bar)	Temperature °F (°C)
291 (20)	-4 - +176 (-20 - +80) ※

※ : Valves up to 392°F(200°C) are available. Please contact **Fujikin** for more information.

Exceptions:
Applicable fluid: Water, Air, Nitrogen gas, inter gas like Helium, and non-corrosive gas and liquid.

Panel Mounting Procedures

If you are panel-mounting the valve, follow these instructions:

1. Ensure that the bracket hole on the panel is ≤ 0.5mm wider than the valve's Panel-Mounting Diameter (refer to the CAD drawing).
2. Use an adjustable wrench to loosen the Hex Nut securing the Handle. Remove the Handle.
3. Remove the Gland Nut and the Panel Nut.
4. Mount the valve on the panel and secure it with the Panel Nut. Reattach the Gland Nut and the Handle.
5. Please assemble the Handle at the end.

Note: Materials and dimensions are subject to change without notice.

Instrument Manifolds

Features

1. **Fujikin** offers a variety of 2-, 3-, and 5-Valve Instrument Manifolds.
2. The 2-Valve Manifolds are designed for static pressure and liquid level applications ; the 3- and 5-Valve Manifolds are designed for differential pressure applications.
3. The flow through a **Fujikin** manifold is controlled by a series of stainless steel needle valves.
4. Each valve has a specific function — to block pressure, to bleed off pressure, or to equalize pressure — depending on its location on the manifold.
The control of all these functions is shared by two needle valve designs
a large bonnet needle valve for manifold orifices of 0.156 in. (4 mm)
a small bonnet needle valve for manifold orifices of 0.125 in. (3.2 mm).
5. End connections - 1/2 in. female pipe (NPT) ; flange (MSS) (Please refer to P149)
6. The bonnet is prevented from loosening from a body with a lock plate. (standard)
(There is also pin lock type. Please refer to P149)
7. On both designs, the stem packing is externally adjustable in the open position.
PTFE is the standard packing material.
8. Distinguished by different colors according to use. with color caps
BLOCK: Blue, BLEED: Red, EQUALIZE: Green

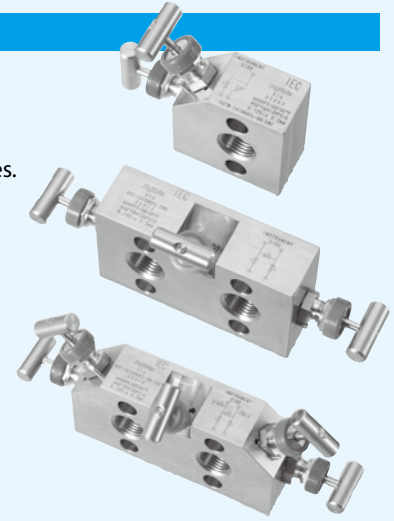

Bonnet Design

Small Bonnet Needle Valves

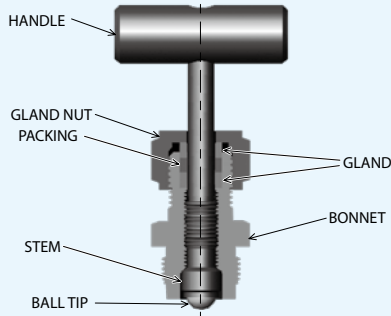

Description	Materials
HANDLE	ASTM A276 304
GLAND NUT	ASTM A276 316
PACKING	PTFE
GLAND	ASTM A276 316
BONNET	ASTM A479 316
STEM	ASTM A276 316
BALL TIP	ASTM A276 316

Large Bonnet Needle Valves

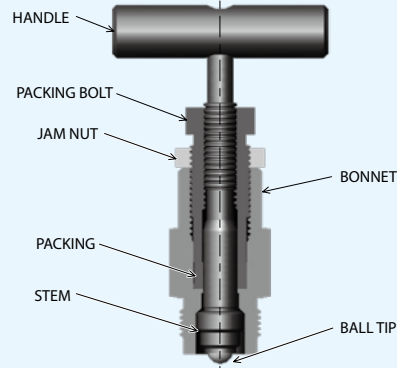

Description	Materials
HANDLE	ASTM A276 304
JAM NUT	ASTM A276 304
PACKING BOLT	ASTM A276 316
BONNET	ASTM A479 316
PACKING	PTFE
STEM	ASTM A276 316
BALL TIP	ASTM A276 316

Cautions: ASTM A276 material may use SUS (ASTM A276 equivalent material).

Technical Data

Temperature and Pressure Rating

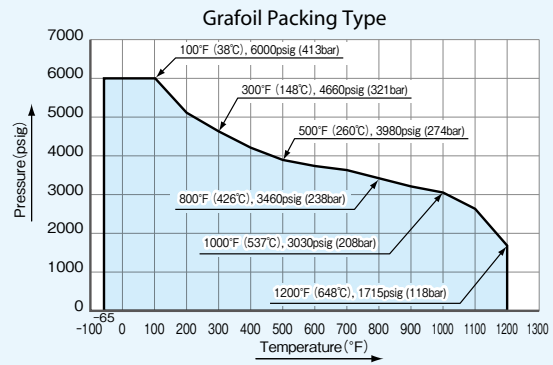
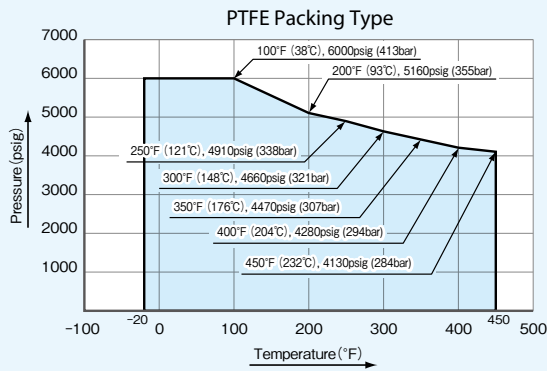

Applicable Fluid

Air, Nitrogen gas, Inert gas like Helium, and non - corrosive gas and liquid.

Material of Construction

Small Bonnet Manifolds

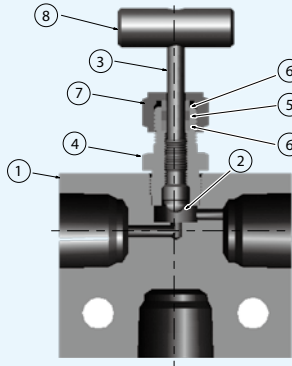

No.	Description	Materials
1	BODY	※ ASTM A479 316
2	BALLTIP	※ ASTM A276 316
3	STEM	※ ASTM A276 316
4	BONNET	※ ASTM A479 316
5	PACKING	※ PTFE
6	GLAND	※ ASTM A276 316
6	GLAND NUT	ASTM A276 304
8	HANDLE	ASTM A276 304

※ : Wetted Parts
 Cautions: ASTM A276 material may use SUS (ASTM A276 equivalent material).

Large Bonnet Manifolds

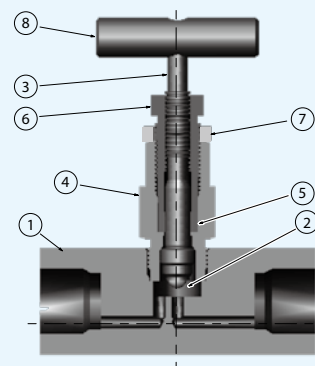

No.	Description	Materials
1	BODY	※ ASTM A479 316
2	BALL TIP	※ ASTM A276 316
3	STEM	※ ASTM A276 316
4	BONNET	※ ASTM A479 316
5	PACKING	※ PTFE
6	PACKING BOLT	ASTM A276 316
7	JAM NUT	ASTM A276 304
8	HANDLE	ASTM A276 304

※ : Wetted Parts
 Cautions: ASTM A276 material may use SUS (ASTM A276 equivalent material).

Dimensions, Flow and Ordering Numbers

2-Valve Manifolds (Consist of one block valve and one vent valve)

Direct Mounting Type

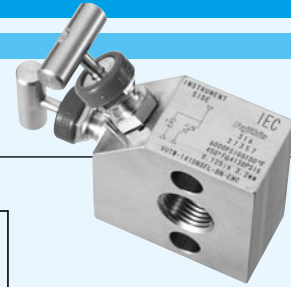

UNIT: in. (mm)

Dimensions

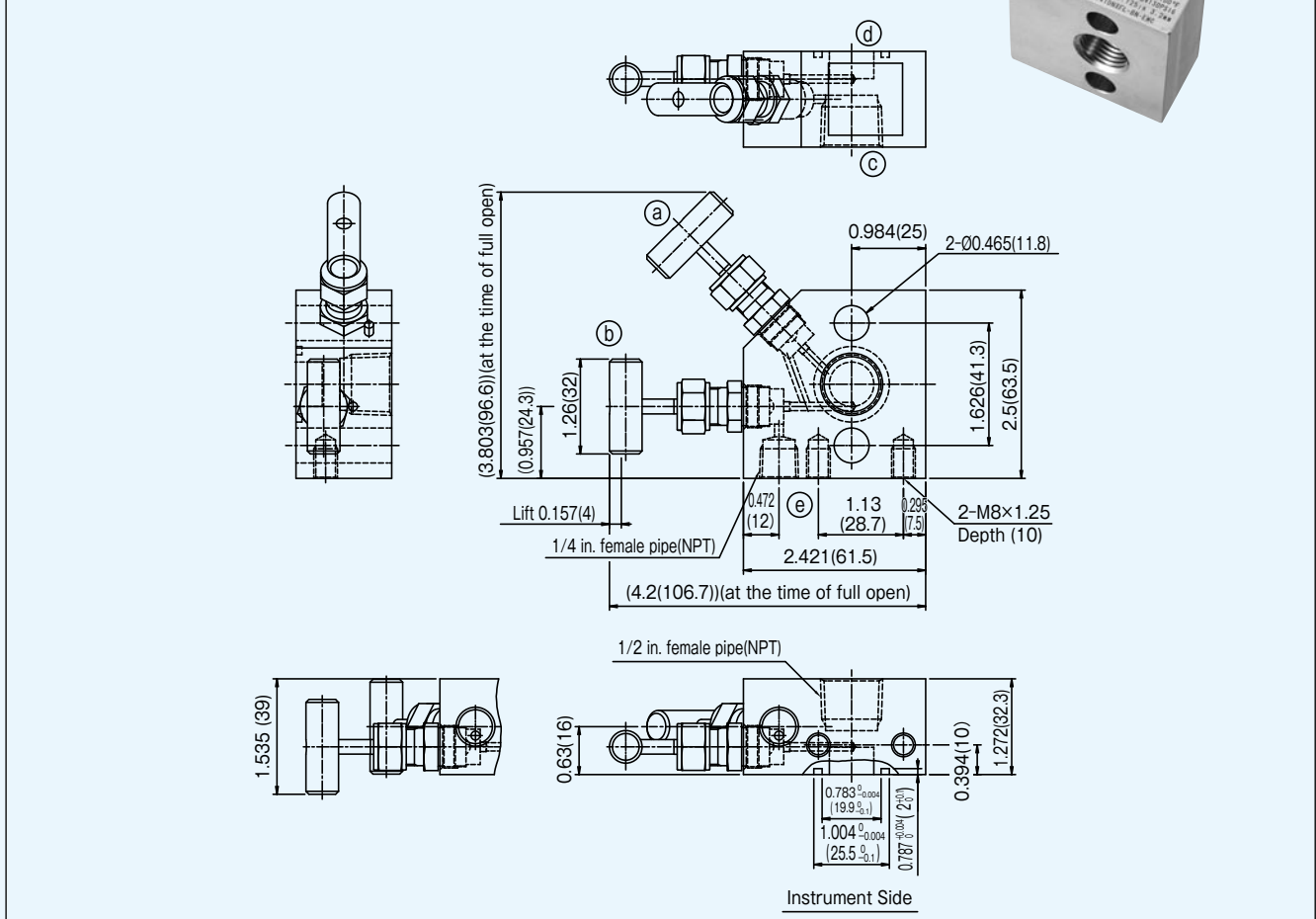

Flow

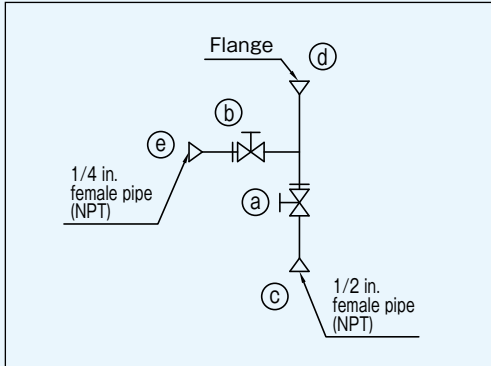

Ordering Number:

- VUTW-141DN×FL-BN-EMC:
Standard (PTFE Packing & no Blind Type)
- VUTW-141DN×FL-BN-EMC-GR:
Graphite Packing Type
- VUTW-141DN×FL-BN-EMC-BL:
with Vent Port Blind Type

Remarks

A gasket and two bolts are attached with this product.

Dimensions, Flow and Ordering Numbers

2-Valve Manifolds (Consist of one block valve and one bleed valve)

Remote Mounting Type

End Connections of Process side, Instrument side:
1/2 in. Female Pipe (NPT)



Dimensions

UNIT: in. (mm)

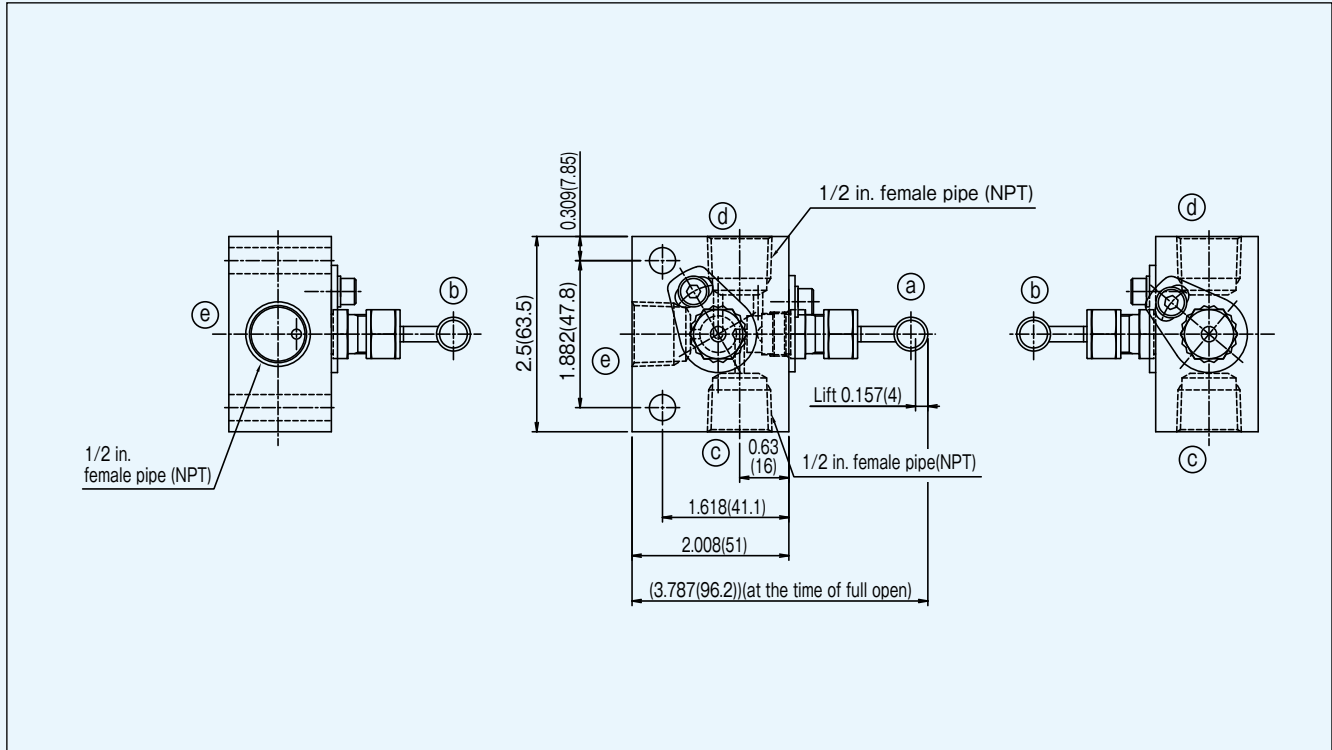

Flow

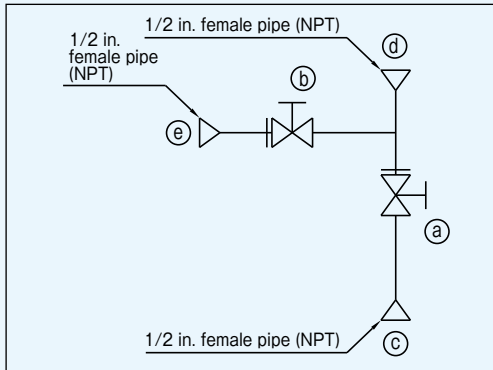

Ordering Number:

- **VUTW-141LDN:**
Standard (PTFE Packing & no Blind Type)
- **VUTW-141LDN-GR:**
Graphite Packing Type
- **VUTW-141LDN-BL:**
with Vent Port Blind Type

Dimensions, Flow and Ordering Numbers

2-Valve Manifolds (Consist of one block valve and one bleed valve)

Direct Mounting Type

End Connections of Process Side: 1/2 in. Female Pipe (NPT),
Instrument side: Flange (MSS)

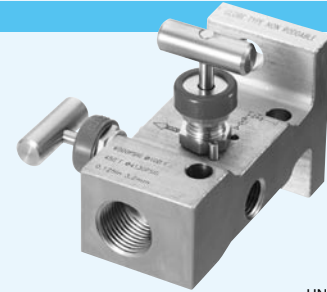

Dimensions

UNIT: in. (mm)

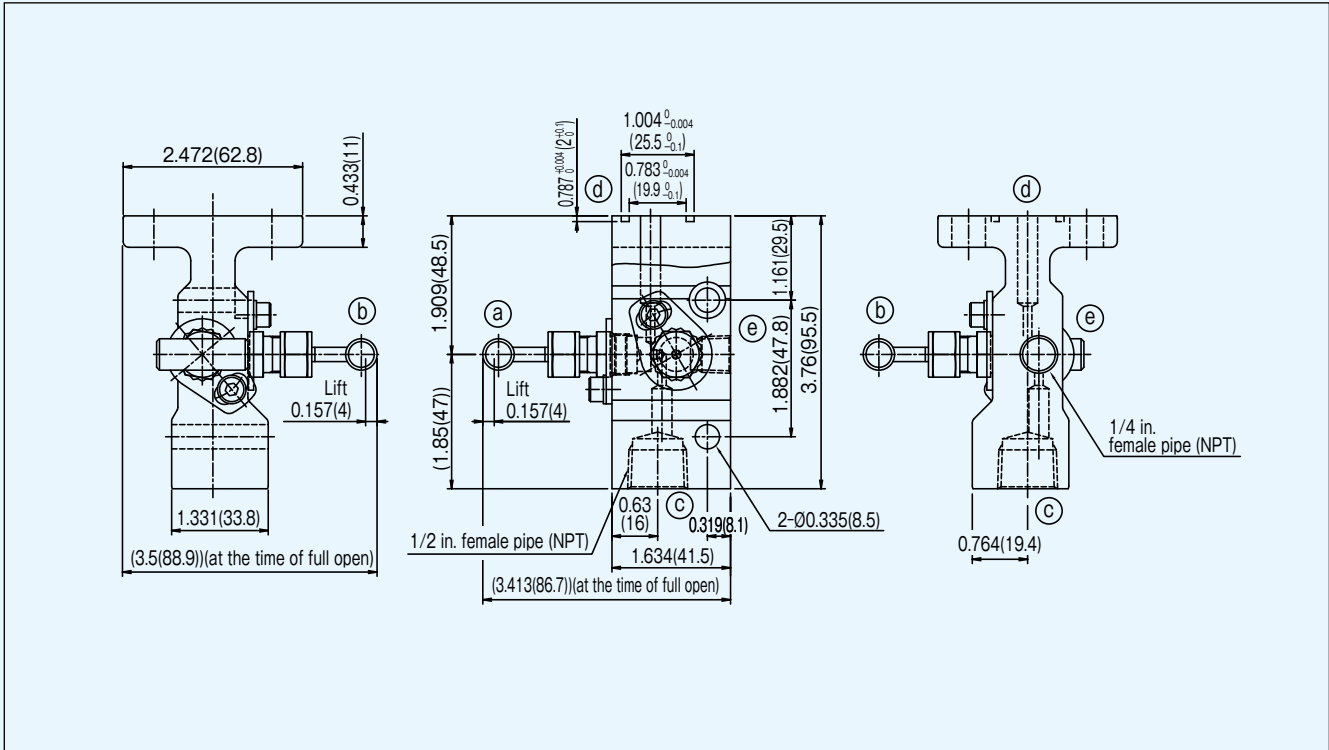

Flow

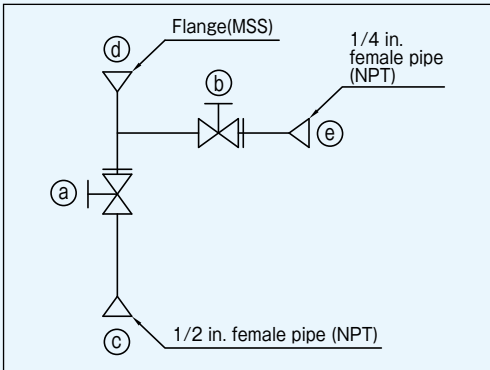

Ordering Number:

- **VUTW-141LDN×FL-BN:**
Standard (PTFE Packing & no Blind Type)
- **VUTW-141LDN×FL-BN-GR:**
Graphite Packing Type
- **VUTW-141LDN×FL-BN-BL:**
with Vent Port Blind Type

Remarks

A gasket and two bolts are attached with this product.

Dimensions, Flow and Ordering Numbers

3-Valve Manifolds (Consist of two block valves and one equalizer valve)

Direct Mounting Type

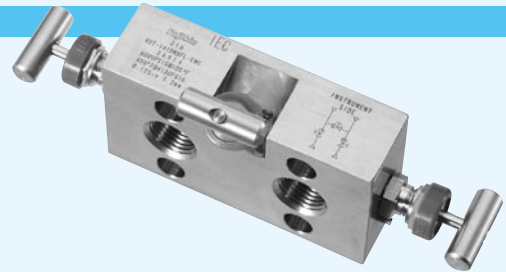

Dimensions

UNIT: in. (mm)

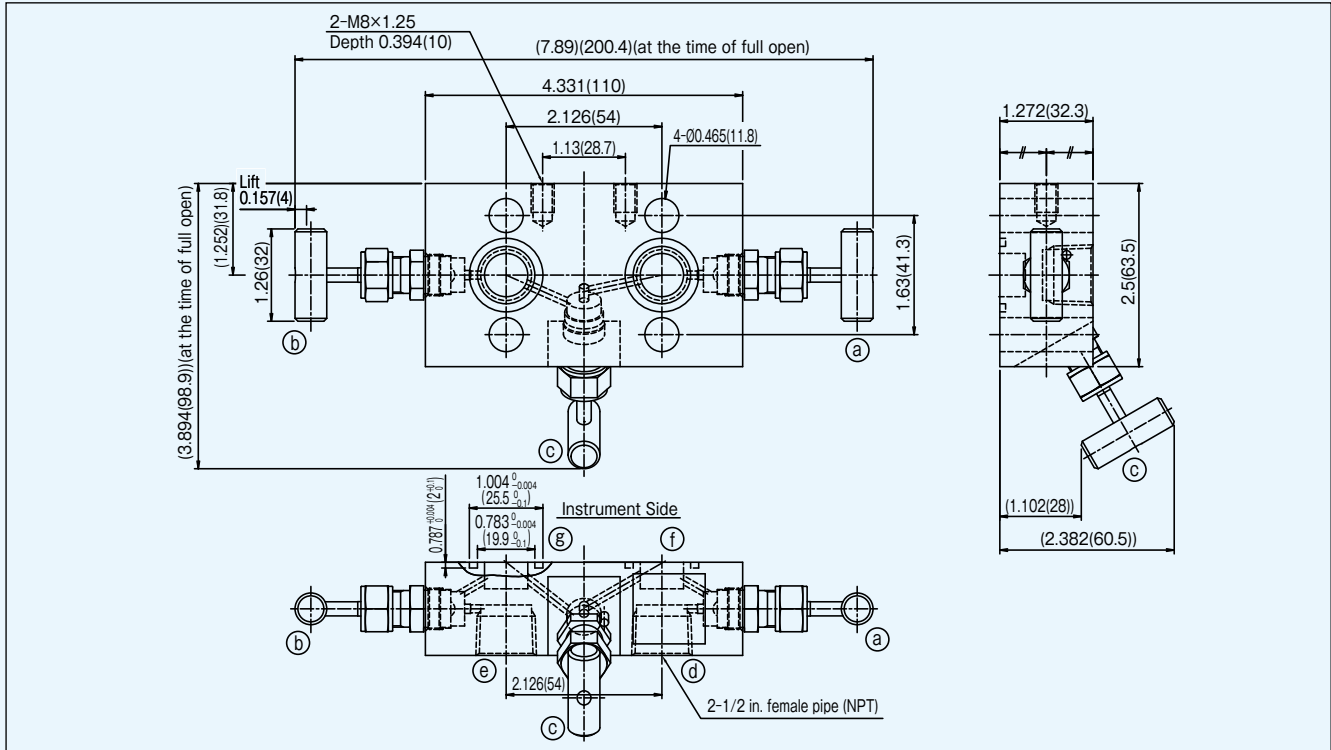

Flow

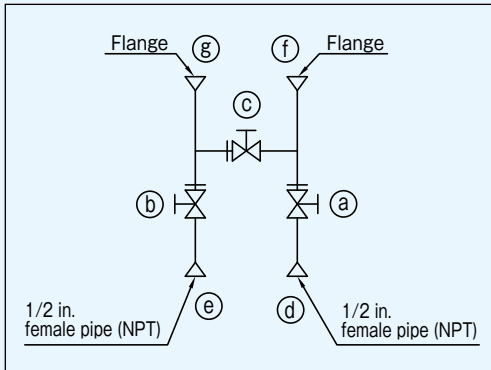

Ordering Number:

- **VUT-141DN×FL-EMC:**
Standard (PTFE Packing & no Blind Type)
- **VUT-141DN×FL-EMC-GR:**
Graphite Packing Type

Remarks

A gasket and two bolts are attached with this product.

Dimensions, Flow and Ordering Numbers

3-Valve Manifolds (Consist of two block valves and one equalizer valve)

Remote Mounting Type

End connections of Process side, Instrument side:
1/2 in. Female Pipe (NPT)

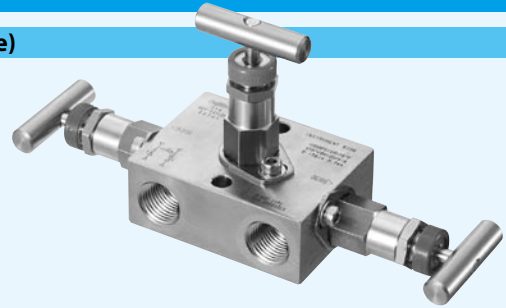

Dimensions

UNIT: in. (mm)

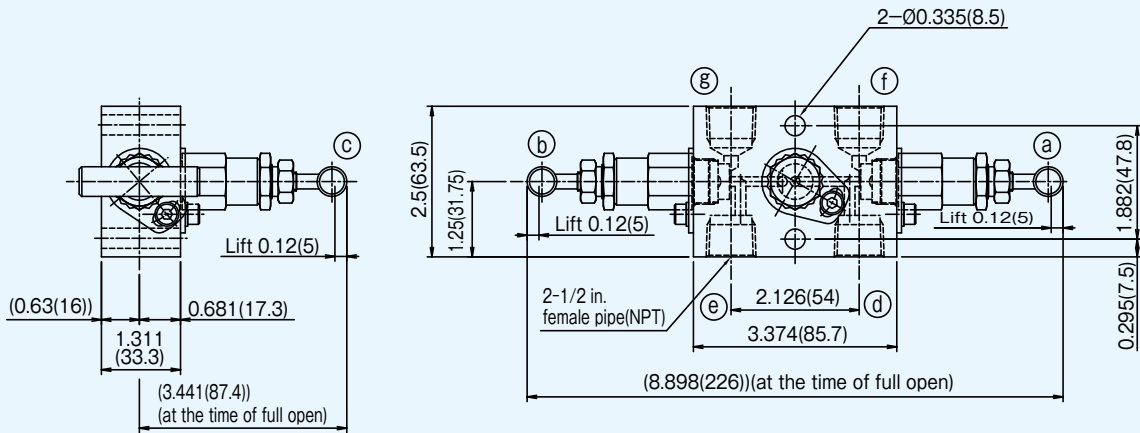

Flow

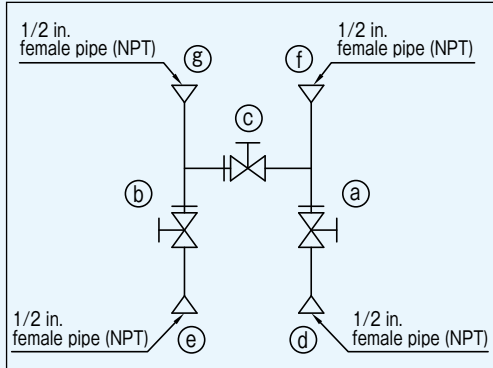

Ordering Number:

- **VUT-141LDN:**
Standard (PTFE Packing & no Blind Type)
- **VUT-141LDN-GR:**
Graphite Packing Type

Dimensions, Flow and Ordering Numbers

3-Valve Manifolds (Consist of two block valves and one equalizer valve)

Direct Mounting Type

End Connections of Process Side: 1/2 in. Female Pipe (NPT),
Instrument side: Flange (MSS)

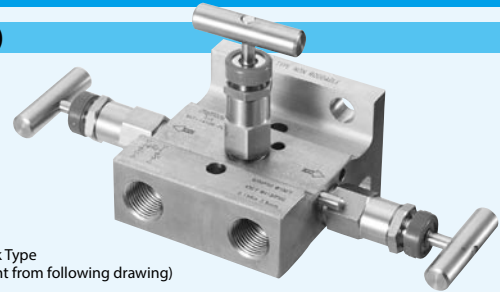

Pin Lock Type
(different from following drawing)

Dimensions

UNIT: in. (mm)

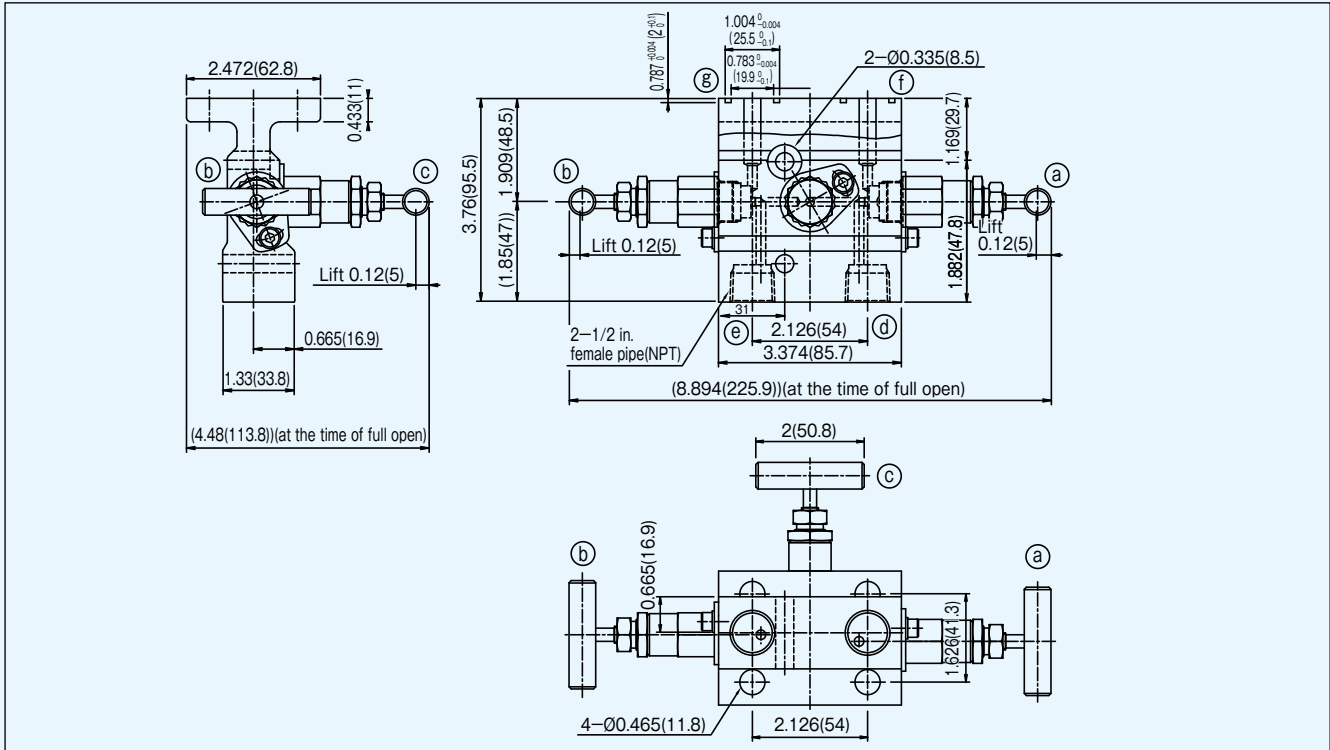

Flow

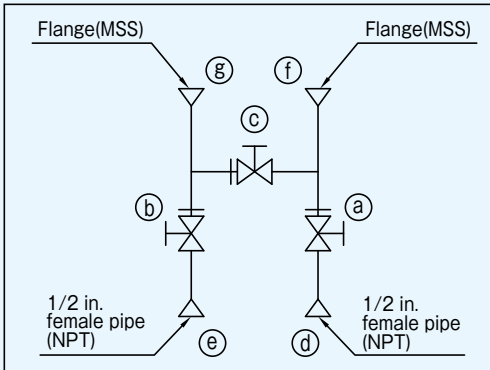

Ordering Number:

- **VUT-141LDN×FL:**
Standard (PTFE Packing & no Blind Type)
- **VUT-141LDN×FL-GR:**
Graphite Packing Type

Remarks

A gasket and two bolts are attached with this product.

Dimensions, Flow and Ordering Numbers

5-Valve Manifolds (Consist of two block valves, one equalizer valve and two bleed valves)

Direct Mounting Type

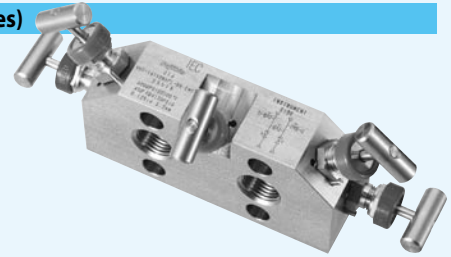

Dimensions

UNIT: in. (mm)

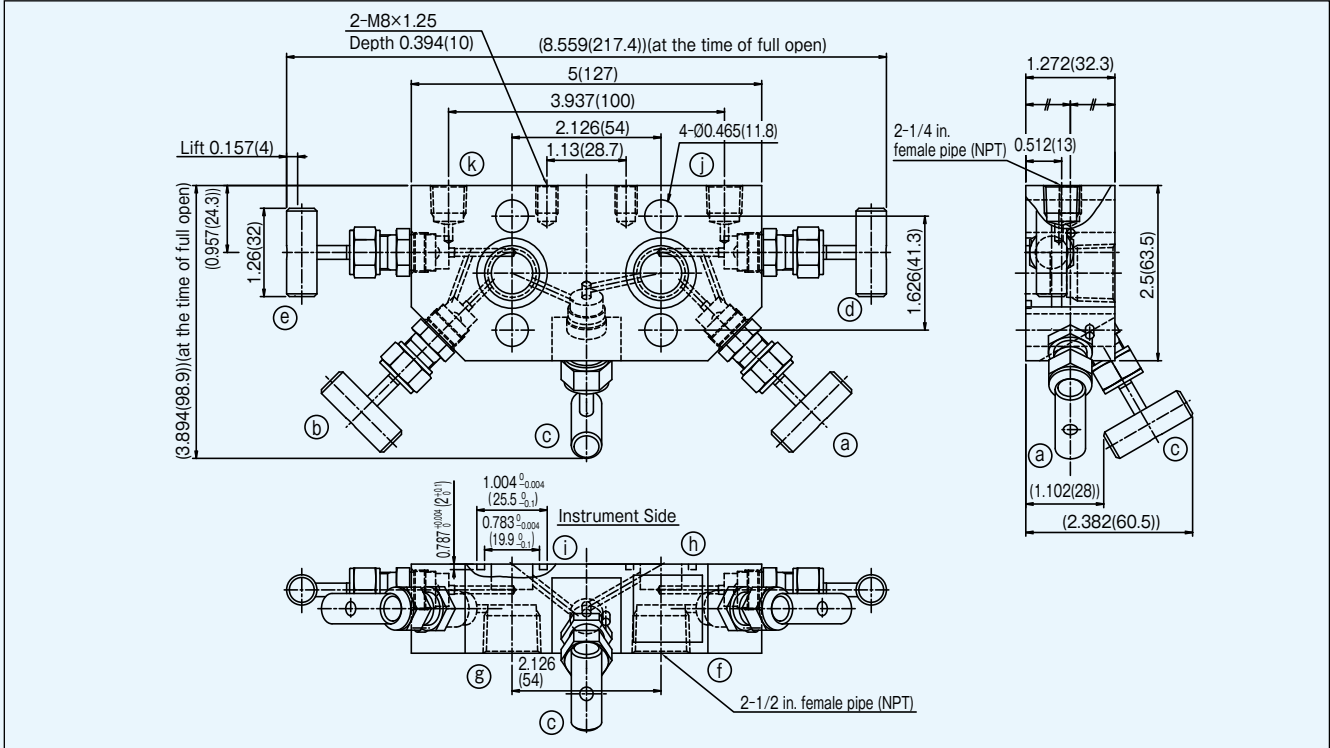

Flow

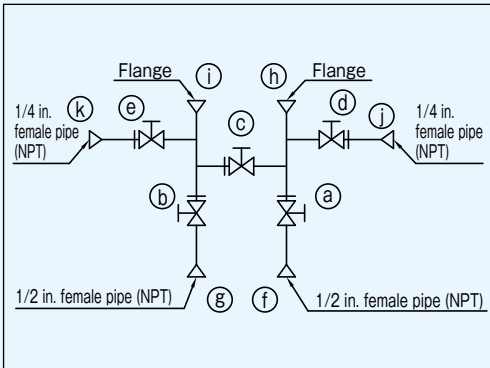

Ordering Number:

- **VUT-141VDN×FL-BN-EMC:**
Standard (PTFE Packing & no Blind Type)
- **VUT-141VDN×FL-BN-EMC-GR:**
Graphite Packing Type
- **VUT-141VDN×FL-BN-EMC-BL:**
with Vent Port Blind Type

Remarks

A gasket and two bolts are attached with this product.

Dimensions, Flow and Ordering Numbers

5-Valve Manifolds (Consist of two block valves, one equalizer valve and two bleed valves)

Remote Mounting Type

End Connections of Process Side, Instrument Side: 1/2 in. Female Pipe (NPT)

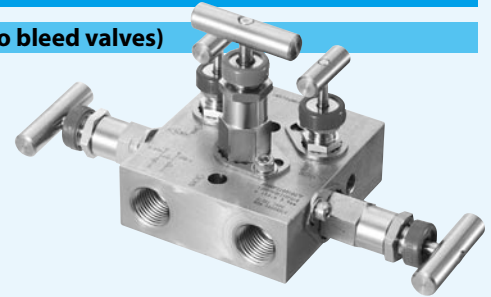

Dimensions

UNIT: in. (mm)

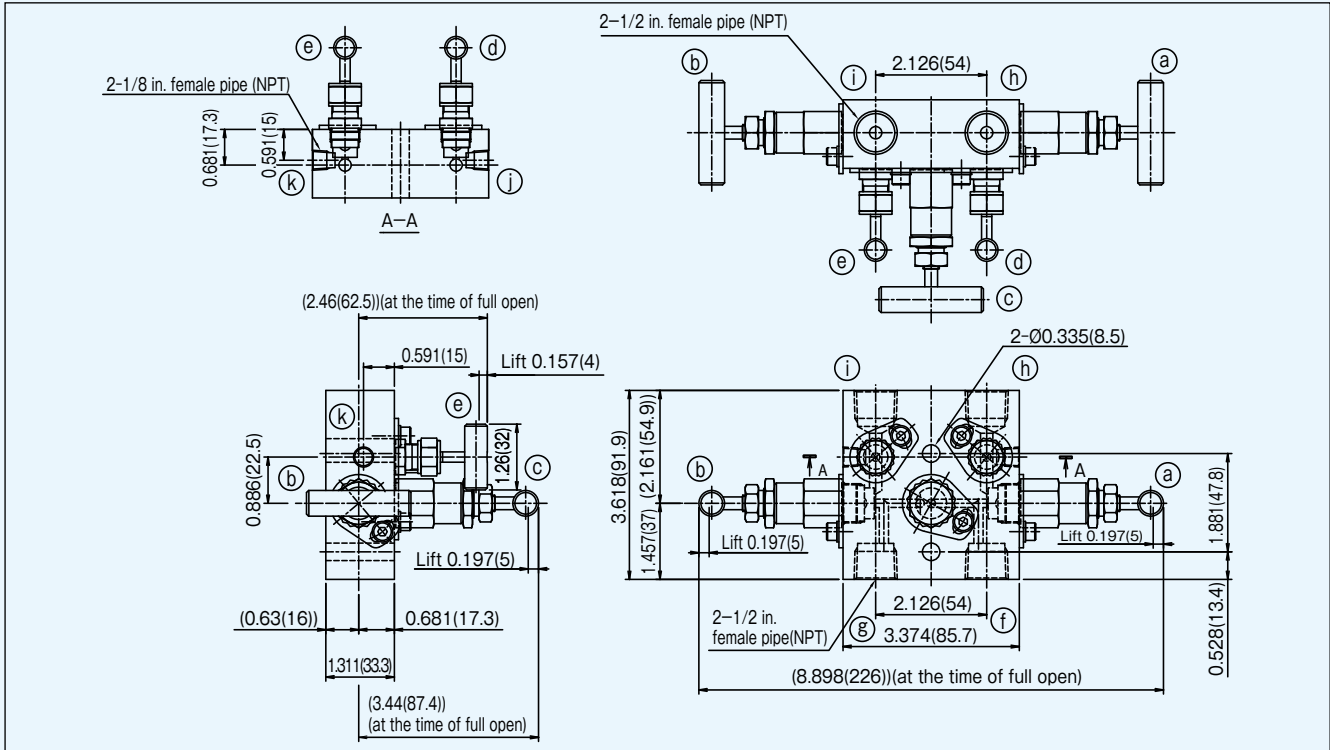

Flow

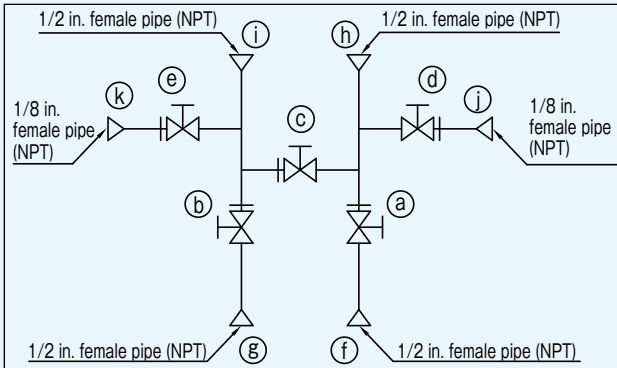

Ordering Number:

- **VUT-141LVDN-AN:**
Standard (PTFE Packing & no Blind Type)
- **VUT-141LVDN-AN-GR:**
Graphite Packing Type
- **VUT-141LVDN-AN-BL:**
with Vent Port Blind Type

Dimensions, Flow and Ordering Numbers

5-Valve Manifolds (Consist of two block valves, one equalizer valve and two bleed valves)

Direct Mounting Type

End Connections of Process Side: 1/2 in. Female Pipe (NPT),
Instrument side: Flange (MSS)

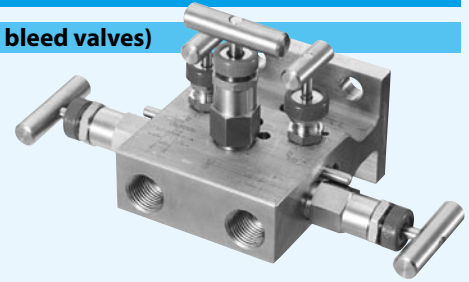

Dimensions

UNIT: in. (mm)

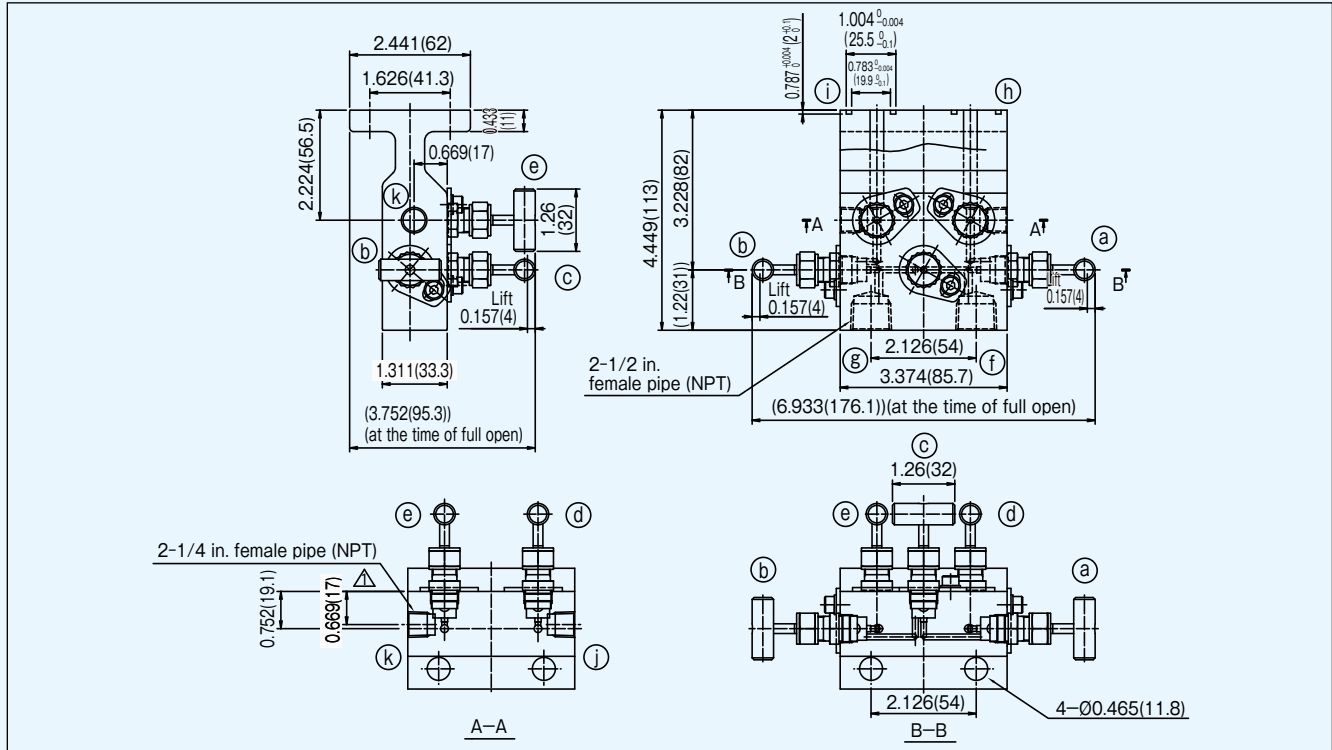

Flow

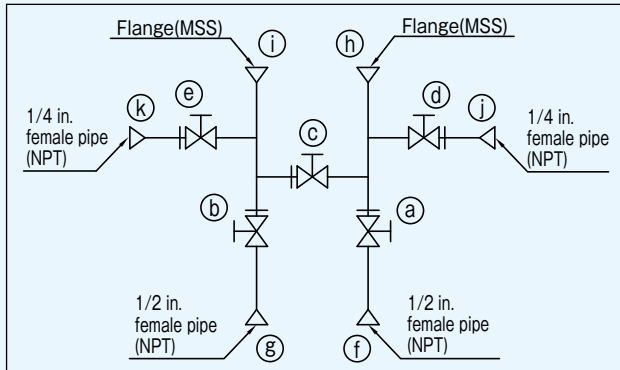

Ordering Number:

- VUT-141LVDN × FL-BN-GUU
Standard (PTFE Packing & no Blind Type)
- VUT-141LVDN × FL-BN-GUU-GR:
Graphite Packing Type
- VUT-141LVDN × FL-BN-GUU-BL:
with Vent Port Blind Type

Remarks

Two gaskets and four bolts are attached with this product.

Option Parts

MANIFOLD BRACKET KIT for Remote Type Manifold Valves (apply to 2 inch pipe)

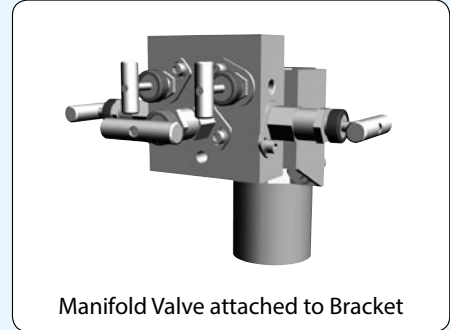
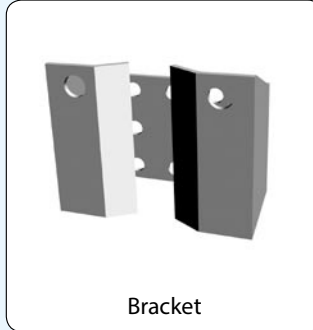
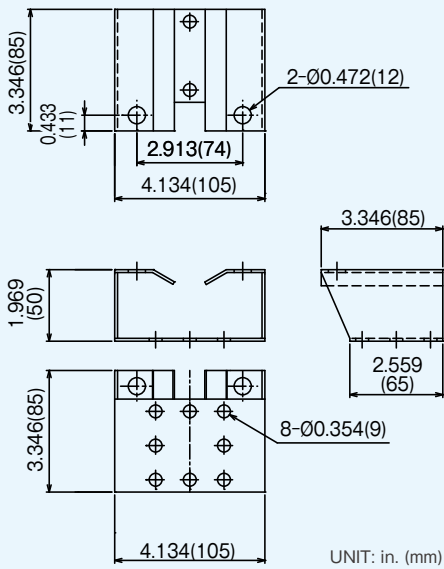

Parts Name	Materials	Q'ty	Remarks
Bracket	SUS304	1	
U-Bolt	SS400	1	MFZn, for 2 In. (M10)
Spring Washer	SS400	2	MFZn, Nominal 10
Hex Nut	SS400	2	MFZn, M10
Hex Bolt	SS400	2	MFZn, M8 x 45
Spring Washer	SS400	2	MFZn, Nominal 8
Hex Nut	SS400	2	MFZn, M8 x 45

The set of a Bracket includes U-Bolt•Spring Washers•Hex Nuts (for Bracket), Hex Bolts•Spring Washers•Hex Nuts(for Valve)

MANIFOLD BRACKET KIT for Direct Mount Type Manifold Valves (-EMC Type) (apply to 2 inch pipe)

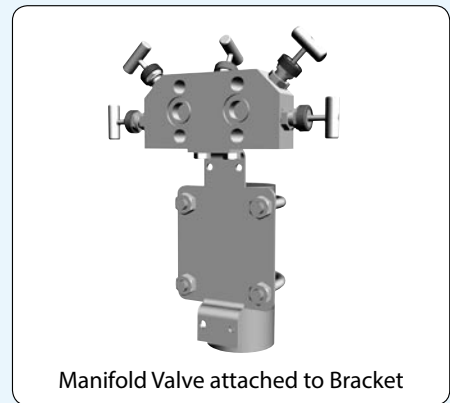
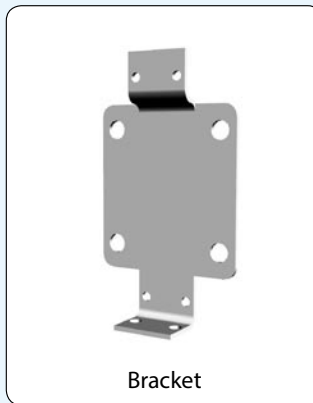
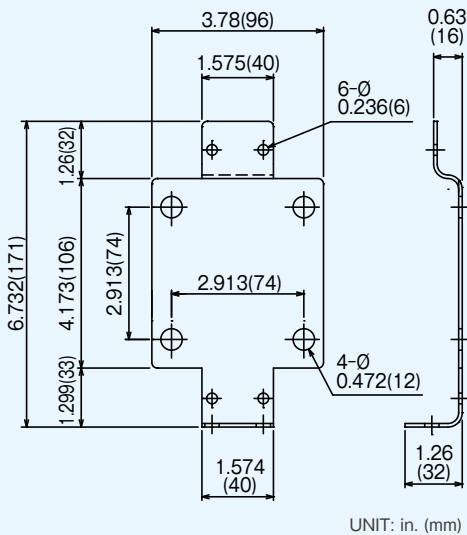

Parts Name	Materials	Q'ty	Remarks
Bracket	SUS304	1	
U-Bolt	SS400	2	MFZn, for 2 In. (M10)
Spring Washer	SS400	4	MFZn, Nominal 10
Hex Nut	SS400	4	MFZn, M10
Hex Bolt	SS400	2	MFZn, M5 x 8
Spring Washer	SS400	2	MFZn, Nominal 8

The set of a Bracket includes U-Bolts•Spring Washers•Hex Nuts (for Bracket), Hex Bolts•Spring Washers

Anti Tamper Handle Type (Small Bonnet Mount Type) is available.

Please remove the special handle from valve at the time of installation.
Please manage to use it only during open/close of valve.

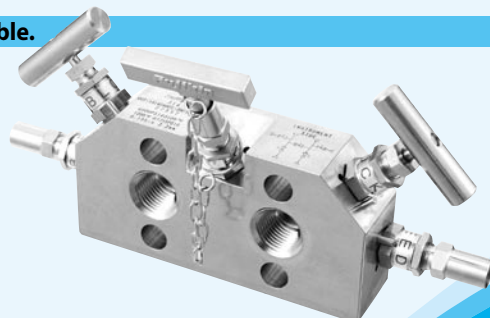

Other Types

Pin Lock Types

Types	End Connections		Flow	Appearance
	Process	Instrument		
2-Valve Manifolds (Consists of one block valve and one bleed valve)	1/2 in. female pipe (NPT)	flange (MSS)		
3-Valve Manifolds (Consists of two block valves and one equalizer valve)	1/2 in. female pipe (NPT)	flange (MSS)		
5-Valve Manifolds (Consists of two block valves, one equalizer valve and two bleed valves)	1/2 in. female pipe (NPT)	flange (MSS)		

Ordering Numbers

V U TW - 1 41 L V DN x FL - BN - EMC - GR - BL

① ② ③ ④ ⑤ ⑥ ⑦ ⑧ ⑨ ⑩ ⑪ ⑫ ⑬

① Series V: V-Series	② Wetted Part (Body) Material U: Stainless steel M: Monel	③ Valve Basic Structure TW: 2-Valve Manifolds T : 3-Valve Manifolds (However, in the item of ⑦, when you choose "V", two Vent Valves are added and it is set to 5-Valve Manifolds.)	④ Inlet Connections 1: Thread Type 2: Flange Type	⑤ Design Pressure 41: Design Pressure 6000psig (413bar)
⑥ Bonnet Lock Structure L: Bonnet; Lock Plate Type (not apply to EMC type) (Blank) : Bonnet; Pin Lock Type	⑦ with Vent Valve V: 5-Valve Manifolds (add two vent valves to 3-Valve Manifolds) (Blank): 3-Valve Manifolds	⑧ Inlet Connections DN: Nominal Diameter 1/2 in. female pipe (NPT) EN : 3/4 in. female pipe (NPT)		
⑨ Outlet connections (Since various connections are available, please consult us.) (Blank) : Same as Inlet Connections XFL : Flange XBN: Thread Size (refer to ⑦)	⑩ Vent Port Connections (Since various connections are available, please consult us.) (Blank) : Same as Inlet Connections AN: Bleed connection; 1/8 in. female pipe (NPT) BN: Bleed connection for bleed valve; 1/4 in. female pipe (NPT) DN: 1/2 in. female pipe (NPT) B : Rc1/4			
⑪ Body Form Supplement (Blank) : Standard Product EMC: Direct Mount Compact Type EME: Anti Tamper Handle Type (Small Bonnet Mount Type) In the case that outlet connection is flange (⑨: XFL) and EME, EMC Type, Body should be Direct Mount Type.	⑫ Packing Material (Blank) : PTFE Packing (Standard) GR: Graphite Packing (In the case that outlet connecting is Flange, accessory gasket also should be graphite.)			
		⑬ Blind (Blank) : Standard (no Blind) BL: with Vent Port Blind		

Gauge Valves

Features

1. Stainless steel construction.
2. Nonrotating ball-tip stem design.
3. Lagging extension body available for insulation clearance.
4. 1/2 and 3/4 in. male to 1/2 in. female pipe (NPT) end connections.
5. 1/2 in. female gauge ports standard.
6. Schedule 160 pipe wall or heavier on valve inlet fitting for strength.
7. Bonnet lock plate standard.

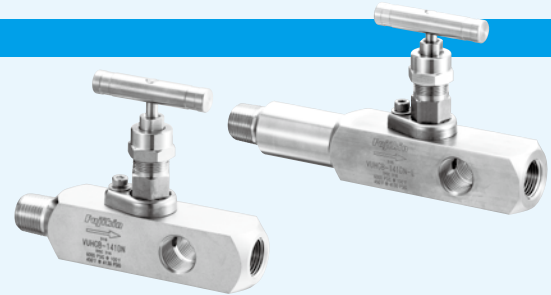

Technical Data

Temperature and Pressure Rating

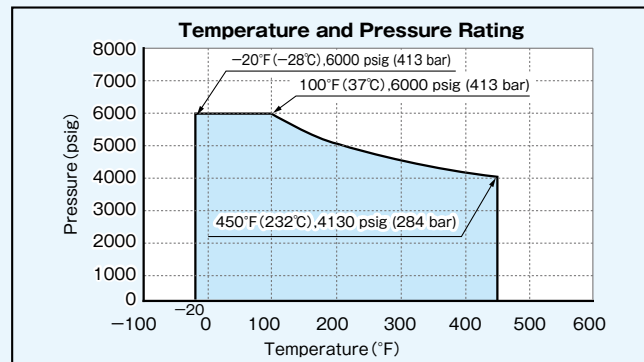

Applicable Fluid

Air, Nitrogen gas, Inert gas like Helium, and non - corrosive gas and liquid.

Material of Construction

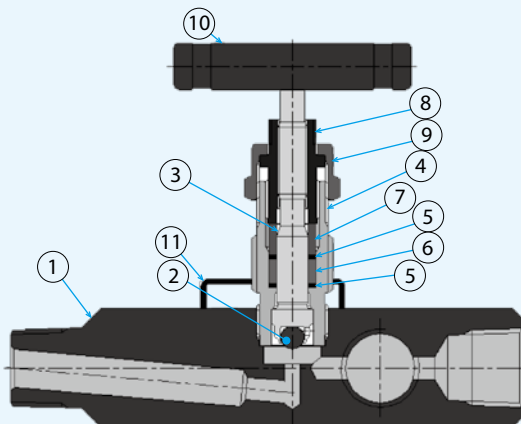

No.	Description	Materials
1	BODY	※ ASTM A479 316
2	BALL	※ ASTM A276 316
3	STEM	※ ASTM A276 316
4	BONNET	※ ASTM A479 316
5	SUPPORT PACKING	※ C-PTFE
6	GLAND PACKING	※ PTFE
7	GLAND	ASTM A276 316
8	PACKING BOLT	ASTM A276 316
9	LOCK NUT	ASTM A276 316
10	HANDLE	ASTM A276 316
11	LOCK PLATE	SUS304

※: Wetted Parts

Cautions: ASTM A276 material may use SUS (ASTM A276 equivalent material).

Dimensions and Ordering Numbers

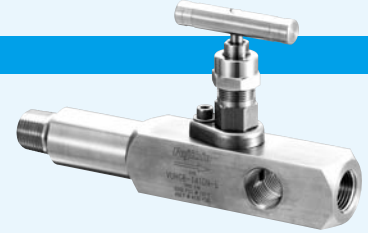
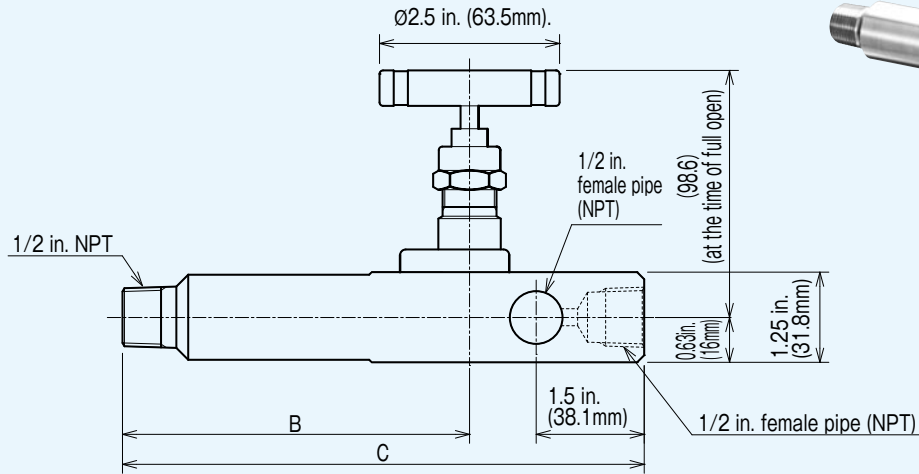

End Connections	Ordering Numbers	Dimensions in. (mm)		Remarks
		B	C	
1/2 in. female pipe (NPT)	VUHGB-141DN	2.97(75.4)	5.39(137)	std. body type
1/2 in. female pipe (NPT)	VUHGB-141DN-L	4.82(122.4)	7.24(184)	extension body type for insulation clearance

Manifold Valves Ordering Number Selection

Request for Quotation & Purchase Order (For attachment)

of the under within the limit indicates, and as attachment data at the time of a request for proposal or order, etc., please utilize after copying this page.

V U TW - 1 41 L V DN × FL - BN - EMC - GR - BL
 ① ② ③ ④ ⑤ ⑥ ⑦ ⑧ ⑨ ⑩ ⑪ ⑫ ⑬

- ① **Series** V: V₆-Series
- ② **Wetted Part (Body) Material** U: Stainless steel
M: Monel
- ③ **Valve Basic Structure** TW: 2-Valve Manifolds
T : 3-Valve Manifolds
(However, in the item of ⑦, when you choose "V", two Vent Valves are added and it is set to 5-Valve Manifolds.)
- ④ **Inlet Connections** 1: Thread Type
2: Flange Type
- ⑤ **Design Pressure** 41: Design Pressure 6000psig (413bar)
- ⑥ **Bonnet Lock Structure** L: Bonnet; Lock Plate Type (not apply to EMC type)
(Blank): Bonnet; Pin Lock Type
- ⑦ **with Vent Valve** V: 5-Valve Manifolds (add two vent valves to 3-Valve Manifolds)
(Blank): 3-Valve Manifolds
- ⑧ **Inlet Connections** DN: Nominal Diameter 1/2 in. female pipe (NPT)
EN: 3/4 in. female pipe (NPT)
- ⑨ **Outlet connections** (Since various connections are available, please consult us.)
(Blank): Same as Inlet Connections
XFL: Flange
XBN: Thread Size (refer to ⑦)
- ⑩ **Vent Port Connections** (Since various connections are available, please consult us.)
(Blank): Same as Inlet Connections
AN: Bleed connection; 1/8 in. female pipe (NPT)
BN: Bleed connection for bleed valve; 1/4 in. female pipe (NPT)
DN: 1/2 in. female pipe (NPT)
B : Rc1/4
- ⑪ **Body Form Supplement** (Blank): Standard Product
EMC: Direct Mount Compact Type
EME: Anti Tamper Handle Type (Small Bonnet Mount Type)
In the case that outlet connection is flange (⑨: XFL)and EME, EMC Type, Body should be Direct Mount Type.
- ⑫ **Packing Material** (Blank): PTFE Packing (Standard)
GR: Graphite Packing (In the case that outlet connecting is Flange, accessory gasket also should be graphite.)
- ⑬ **Blind** (Blank): Standard (no Blind)
BL: with Vent Port Blind

Manifold Valves Ordering Number Selection

V - 41 × - - - -
 ① ② ③ ④ ⑤ ⑥ ⑦ ⑧ ⑨ ⑩ ⑪ ⑫ ⑬

Please put a check mark "✓" into either following check box .

Estimate Request for Quotation

Order

Please indicate quantity either following check box .

Q'ty pcs.

Q'ty pcs.

1000 psig (68.9 bar) Type (VUBF-96P、VUBFD-96P Type)

Features

1. Precision-formed metal bellows provides reliable seal to atmosphere.
2. Sealed between body and bellows by gasket.
3. A positive seal is repeatedly possible with nonrotating spherical disk.
(Metal Seal Type, Soft Seal Type)
4. Panel and bottom mounting.
5. End Connections: **V-Lok** Tube Fittings 1/4, 3/8, 1/2



Metal Seal Type (VUBF-96P Type)

Technical Data

Temperature and Pressure Rating

Nominal Sizes	1/4	3/8	1/2
Temperature °F (°C)	-20 (-28) ~ 600 (315)		
Working Pressure psig (bar)	1000 (68.9)		

Outside Leakage, Seat Leakage

After Pressurise test, we do He leakage test.
We confirm at the time of test that the leakage amount is less than 4.0×10^{-10} Pa·m³/sec. (Vacuum process)

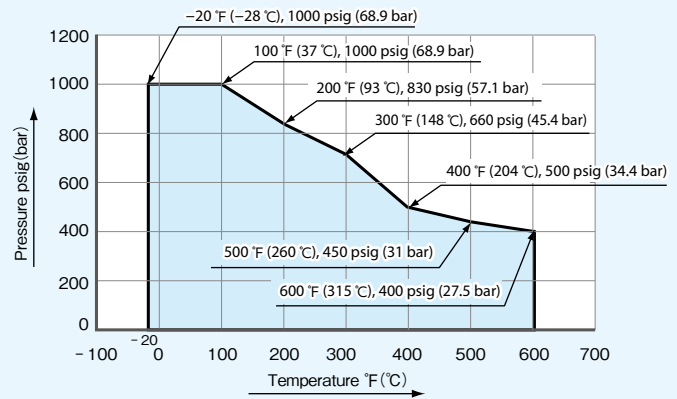

Applicable Fluid

Air, Nitrogen gas, Inert gas like Helium, and non - corrosive gas and liquid.

Materials of Construction

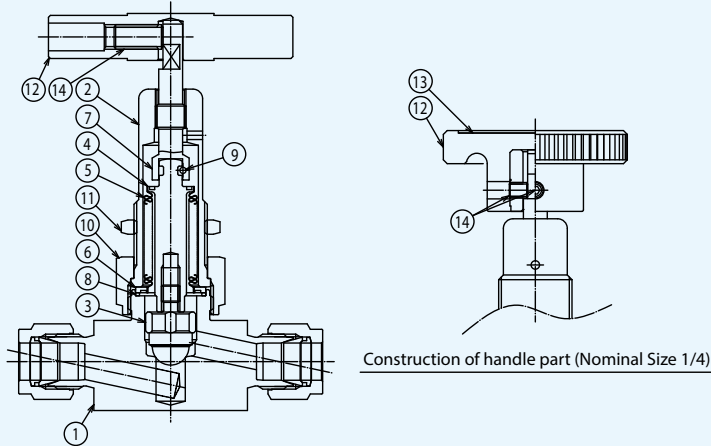

No.	Description	Materials
1	BODY ※	ASTM A479 316
2	BONNET	ASTM A479 316
3	DISK ※	COBALT - BASED ALLOY + ASTM A479 316
4	STEM(1) ※	ASTM A479 316
5	BELLOWS ※	ASTM A240 321 or AMS5510 TYPE321
6	WELD RING ※	ASTM A479 316
7	STEM(2)	ASTM A582 416 or ASTM A582 410
8	GASKET ※	ASTM A580 316
9	STOP PIN	ASTM A276 304
10	BONNET NUT	ASTM A479 316
11	PANEL NUT	ASTM A276 304 or ASTM A276 316
12	HANDLE	Nom. Size 6.35: PHENOLIC RESIN + ZDC2 Nom. Size 9.52, 12.7: ALUMINUM A5056B or A6061B(T6)
13	NAME PLATE(Nominal Size 1/4)	POLYESTER
14	SET SCREW	ASTM A276 304

※ : Wetted Parts

Soft Seal Type (VUBFD-96P Type)

Technical Data

Temperature and Pressure Rating

Nominal Sizes	1/4	3/8	1/2
Temperature °F (°C)	-20 (-28) ~ 200 (93)		
Working Pressure psig (bar)	1000 (68.9)		

Outside Leakage, Seat Leakage

After Pressurise test, we do He leakage test.
We confirm at the time of test that the leakage amount is less than 4.0×10^{-10} Pa · m³ /sec. (Vacuum process)

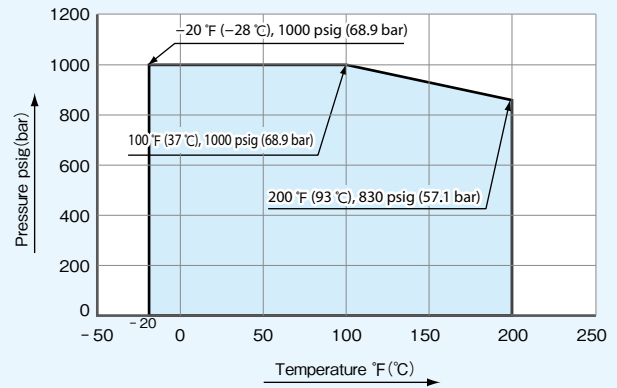

Applicable Fluid

Air, Nitrogen gas, Inert gas like Helium, and non - corrosive gas and liquid.

Materials of Construction

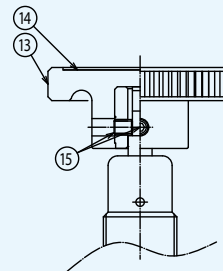
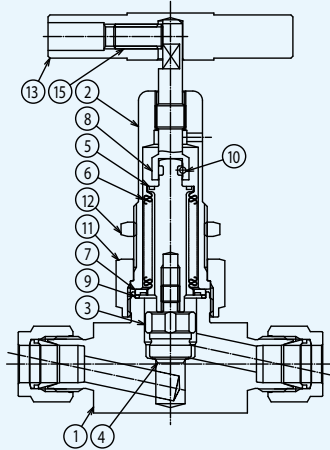

Construction of handle part (Nominal Size 1/4)

No.	Description	Materials
1	BODY ※	ASTM A479 316
2	BONNET	ASTM A479 316
3	DISK ※	ASTM A479 316
4	DISK PACKING ※	PCTFE
5	STEM(1) ※	ASTM A479 316
6	BELLOWS ※	ASTM A240 321 or AMS 5510 TYPE 321
7	WELD RING ※	ASTM A479 316
8	STEM(2)	ASTM A582 416 or ASTM A582 410

No.	Description	Materials
9	GASKET ※	ASTM A580 316
10	STOP PIN	ASTM A276 304
11	BONNET NUT	ASTM A276 304 or ASTM A276 316
12	PANEL NUT	ASTM A276 316
13	HANDLE	Nom. Size 6.35: PHENOLIC RESIN + ZDC2 Nom. Size 9.52, 12.7: ALUMINUM A5056B or A6061B(T6)
14	NAME PLATE(Size 6.35)	POLYESTER
15	SET SCREW	ASTM A276 304

※ : Wetted Parts

Dimensions and Ordering Numbers

End Connection V-Lok Tube Fitting Type

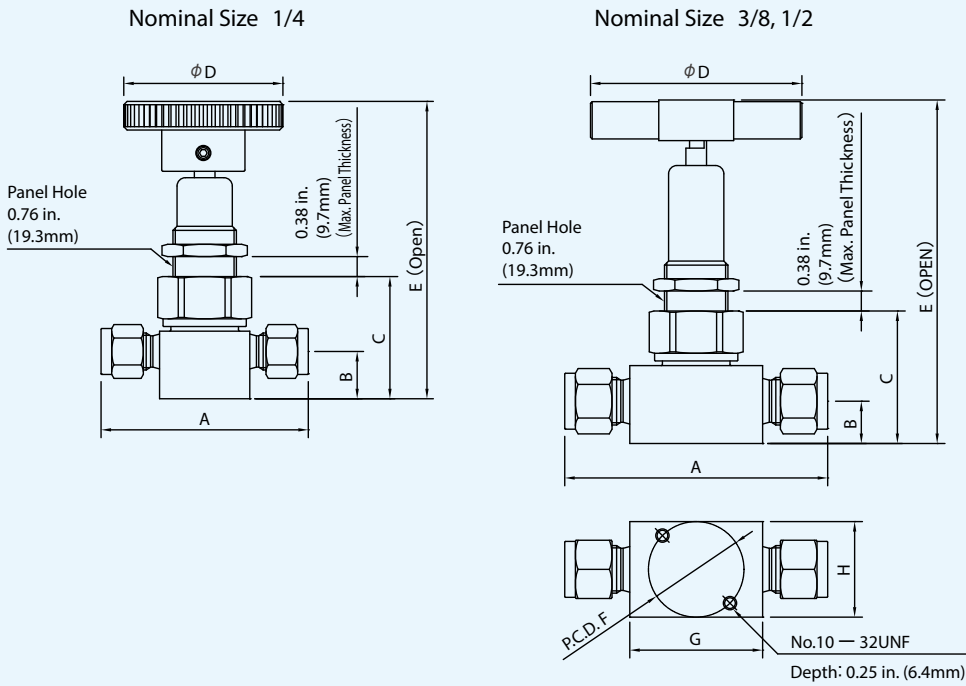

End Connection UJR Tube Fitting Type

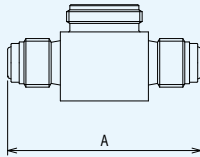

End Connections (Inlet/Outlet)	Nominal Diameter	Orifice inch (mm)	Dimensions inch (mm)								Ordering Numbers
			A	B	C	D	E	F	G	H	
V-Lok	1/4	0.16 (4.1)	2.46 (62.5)	0.56 (14.2)	1.45 (36.8)	1.88 (47.8)	3.64 (92.5)	1 (25.4)	1.06 (26.9)	1 (25.4)	VUBF-96P-6.35 VUBFD-96P-6.35
	3/8	0.3 (7.6)	3.09 (78.5)	0.5 (12.7)	1.57 (39.9)	2.5 (63.5)	4.17 (106)	1.13 (28.7)	1.57 (39.9)	1.13 (28.6)	VUBF-96P-9.52 VUBFD-96P-9.52
			3.3 (83.8)								VUBF-96P-12.7 VUBFD-96P-12.7
	1/2										VUBF-96P-12.7 VUBFD-96P-12.7
UJR	1/4	0.16 (4.1)	2.24 (56.9)	0.44 (11.2)	1.45 (36.8)	1.88 (47.8)	3.64 (92.5)	1 (25.4)	1.02 (25.9)	1 (25.4)	VUBF-76P-6.35 VUBFD-76P-6.35
	3/8	0.3 (7.6)	3 (76.2)	0.46 (11.7)	1.57 (39.9)	2.5 (63.5)	4.17 (106)	1.13 (28.7)	1.5 (38)	1.13 (28.7)	VUBF-76P-9.52 VUBFD-76P-9.52

1000 psig (68.9 bar) Compact Type (VUBFH-96P Type)

Features

1. Precision-formed metal bellows provides reliable seal to atmosphere.
2. Welded bonnet to body provides perfect seal to atmosphere.
3. A positive seal is repeatedly possible with nonrotating spherical disk.
4. Panel and bottom mounting.
5. End Connections: **V-Lok** Tube Fittings 1/16, 1/4



Technical Data

Temperature and Pressure Rating

Size	1/16	1/4
Temperature °F (°C)	-80 (-62) ~ 600 (315)	
Working Pressure psig (bar)	1000 (68.9)	

Outside Leakage, Seat Leakage

After Pressurise test, we do He leakage test.
We confirm at the time of test that the leakage amount is less than 4.0×10^{-10} Pa·m³/sec. (Vacuum process)

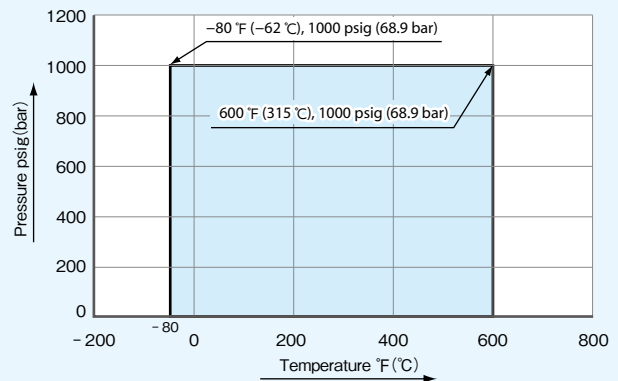

Applicable Fluid

Air, Nitrogen gas, Inert gas like Helium, and non - corrosive gas and liquid.

Materials of Construction

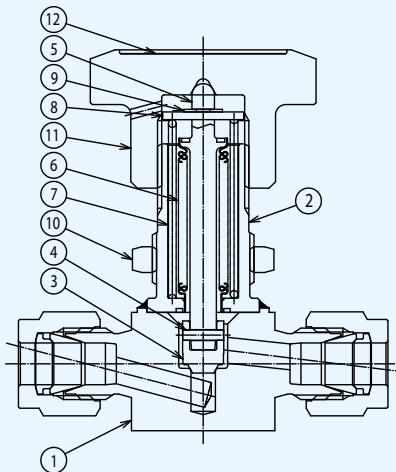

No.	Description	Materials
1	BODY ※	ASTM A479 316
2	BONNET ※	ASTM A479 316
3	DISK ※	S17400 or ASTM A276 630
4	STOP PIN ※	SUS304
5	STEM ※	ASTM A479 316
6	BELLOWS ※	ASTM A240 321 or AMS 5510 TYPE 321
7	SPRING	S17700 or ASTM A276 631
8	WASHER	ASTM A240 316
9	E - RING	ASTM A276 304
10	PANEL NUT	ASTM A276 304 or ASTM A479 316
11	HANDLE	ALUMINUM A5056B or A6061B(T6)
12	NAME PLATE	TETORON

※ : Wetted Parts

Dimensions and Ordering Numbers

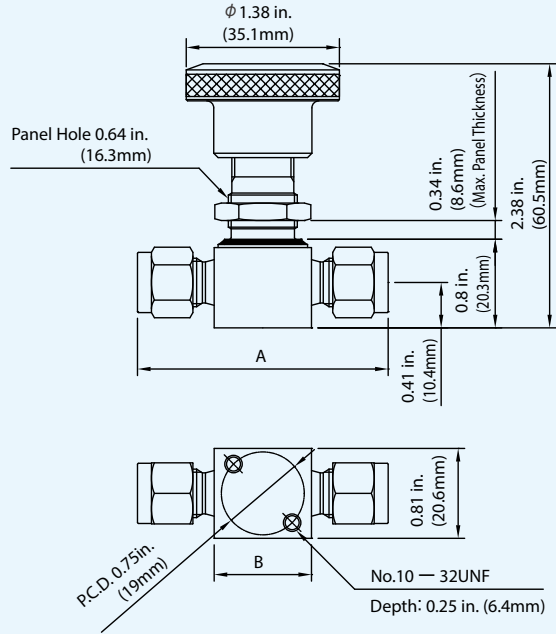

End Connections	Nominal Sizes	Orifice inch (mm)	Dimensions inch (mm)		Ordering Numbers
			A	B	
Inlet / Outlet	1/8	0.15 (3.8)	2.09 (53.1)	0.88 (22.3)	VUBFH - 96P - 3.2
	1/4		2.27 (57.7)		VUBFH - 96P - 6.35

700 psig (48.2 bar) Metering Needle Bellows Valves (VUBFN-94MP Type)

Features

1. Minutes flow control type disk.
2. Micrometer handles provide precise flow control repeatedly.
3. Precision- formed metal bellows provides reliable seal to atmosphere.
4. Valves open to maximum flow in six turns.
5. Slotted handle tops enable adjustments with screwdriver.
6. Sealed between body and bellows by gaskets.
7. Panel and bottom mounting.
8. End Connection: **V-Lok** Tube Fitting 1/4



Technical Data

Temperature and Pressure Rating

Nominal Size	1/4
Temperature °F(°C)	- 20 (- 28) ~ 600 (315)
Working Pressure psig (bar)	700 (48.2)

Outside Leakage, Seat Leakage

After Pressurise test, we do He leakage test.
We confirm at the time of test that the leakage amount is less than 4.0×10^{-10} Pa·m³/sec. (Vacuum process)

Flow Rate at the shut time

We adjust the flow rate of 9.86psig (0.68bar) Nitrogen gas
10-15cm³/min. (At the shipment time)

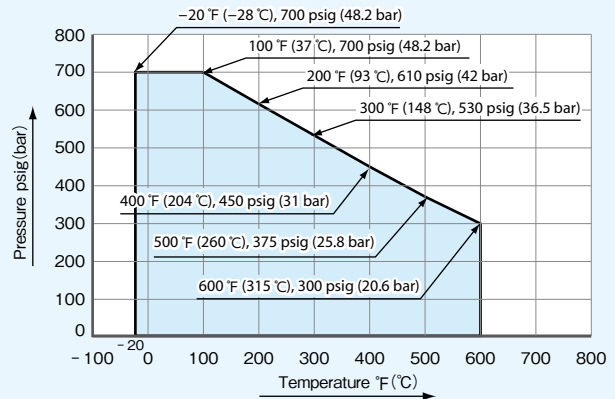

Applicable Fluid

Air, Nitrogen gas, Inert gas like Helium, and non - corrosive gas and liquid.

Materials of Construction

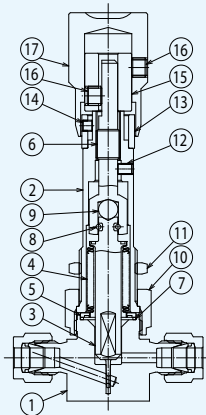

No.	Description	Materials
1	BODY ※	ASTM A479 316
2	BONNET	ASTM A479 316
3	DISK ※	ASTM A479 316
4	BELLOWS ※	ASTM A240 321 or AMS 5510 TYPE 321
5	WELD RING ※	ASTM A479 316
6	STEM	ASTM A582 416 or ASTM A582 410
7	GASKET ※	ASTM A580 316
8	STOP PIN	SUS304
9	BALL	SUS420C
10	BONNET NUT	ASTM A479 316
11	PANEL NUT	ASTM A276 304 or ASTM A276 316
12	SET SCREW	ASTM A276 304
13	INDICATOR SCALE	ASTM A582 303
14	SET SCREW	ASTM A276 304
15	BUSH	ASTM A582 303
16	SET SCREW	ASTM A276 304
17	HANDLE	ASTM A582 313

※ : Wetted Parts

Dimensions and Ordering Numbers

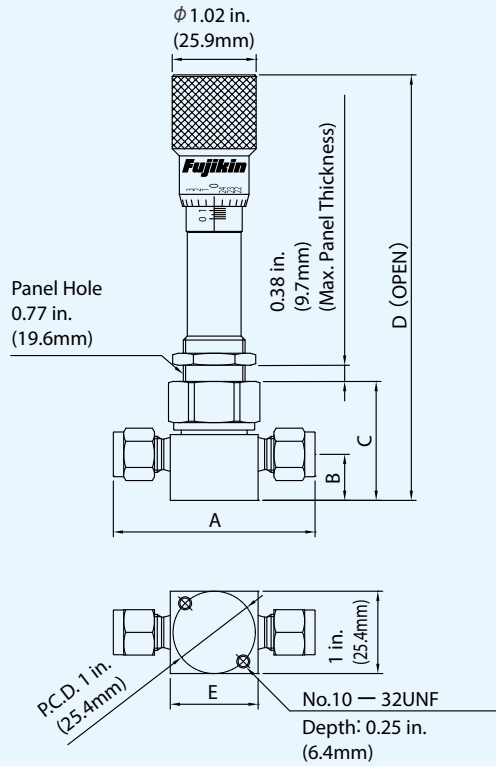

V-Lok Type

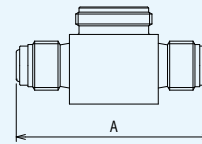

UJR Type



End Connections	Nominal Diameter	Orifice inch (mm)	Dimensions inch (mm)					Ordering Numbers
			A	B	C	D	E	
V-Lok	1/4	0.055 (1.4)	2.46 (62.5)	0.56 (14.2)	1.45 (36.8)	5.24 (133)	0.07 (27.1)	VUBFN-94MP-6.35
UJR	1/4	0.055 (1.4)	2.24 (56.9)	0.44 (11.2)	1.45 (36.8)	5.16 (131)	1.02 (25.9)	VUBFN-74MP-6.35

Flow Rate Curve & Cv Value

Flow Rate Curve

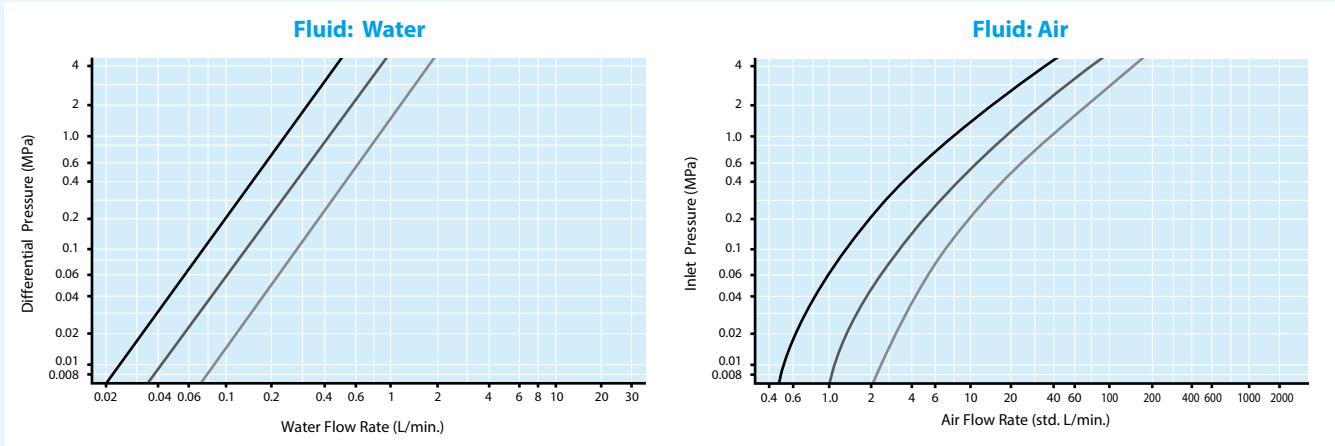

Cv Value

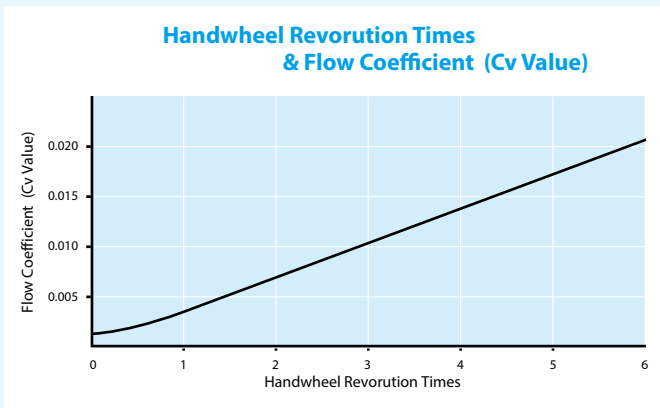

Features

1. Compact Design
2. Open and Close quickly
3. Panel Mounting
4. End Connections **V-Lok** Tube Fittings

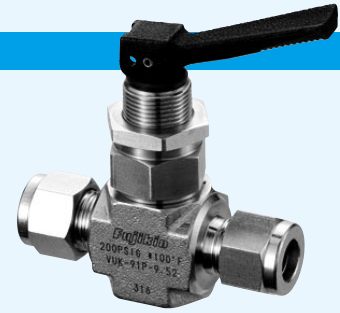
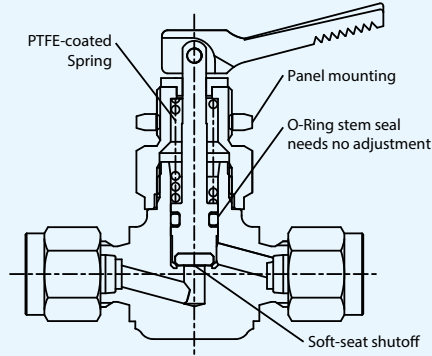

Technical Data

Temperature and Pressure Rating

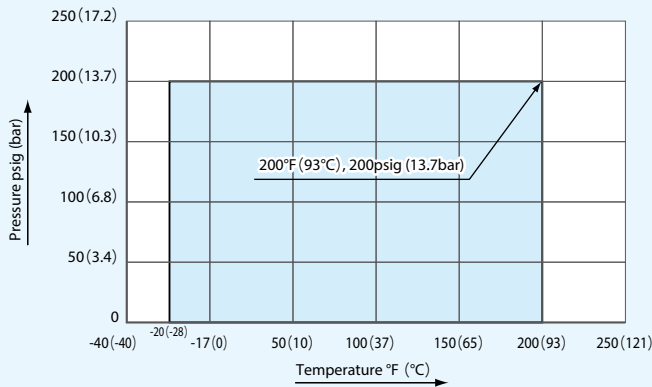

Applicable Fluid

Air, Nitrogen gas, Inert gas like Helium, and non - corrosive gas and liquid.

Materials of Construction

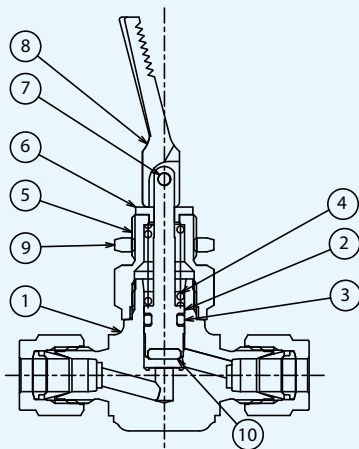

No.	Description	Material
1	BODY ※	ASTM A182 316
2	STEM ※	ASTM A276 316
3	O-RING ※	FKM
4	SPRING	SUS631J1
5	PACKING NUT	ASTM A276 316
6	WASHER	NYLON
7	ROLL PIN	SUS304
8	HANDLE	NYLON
9	PANEL NUT	ASTM A276 304 or ASTM A276 316
10	STEM TIP ※	PTFE
Lubricants		Fluorinated-based

※ : Wetted Parts

Dimensions

Globe Type

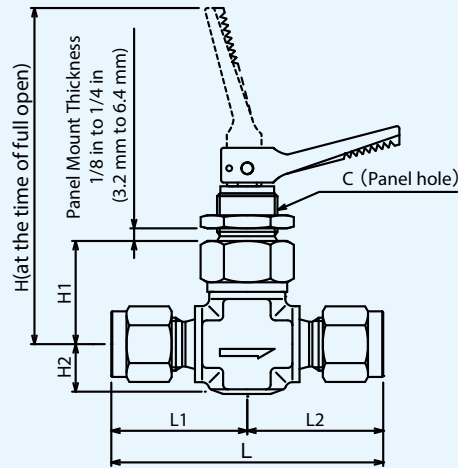

Connection Types	Nominal Diameter inch (mm)	Operating Pressure psi (bar)	Orifice inch (mm)	Dimensions inch (mm)						Ordering Numbers
				L	L1	L2	H	H1	H2	
V-Lok	1/4 (6.35)	200 (137)	0.126 (3.2)	2.26 (57.4)	1.13 (28.7)	2.81 (71.4)	0.68 (21.8)	0.37 (9.5)	0.53 (13.5)	VUK-91P-6.35
	3/8 (9.52)		0.252 (6.4)	2.58 (65.5)	1.29 (32.8)	3.56 (90.4)	1.06 (26.9)	0.5 (12.7)	0.66 (16.8)	VUK-91P-9.52
	1/2 (12.7)			2.8 (71.1)	1.4 (35.6)					VUK-91P-12.7
	- (6)		0.126 (3.2)	2.26 (57.4)	1.13 (28.7)	2.81 (71.4)	0.86 (21.8)	0.37 (9.5)	0.53 (13.5)	VUK-91P-6
	- (8)			2.22 (56.4)	1.11 (28.2)					VUK-91P-8
	- (10)		0.252 (6.4)	2.72 (69.1)	1.36 (34.5)	3.56 (90.4)	1.06 (26.9)	0.5 (12.7)	0.66 (16.8)	VUK-91P-10
	- (12)			2.92 (74.2)	1.46 (37.1)					VUK-91P-12
Rc	1/8		0.126 (3.2)	1.63 (41.4)	0.81 (20.6)	2.81 (71.4)	0.86 (21.8)	0.37 (9.5)	0.53 (13.5)	VUK-11PA
	1/4		0.252 (6.4)	2.12 (53.8)	1.06 (26.9)	3.56 (90.4)	1.06 (26.9)	0.5 (12.7)	0.66 (16.8)	VUK-11PB
Rc	1/8		0.126 (3.2)	1.72 (43.7)	0.86 (21.8)	2.83 (71.4)	0.86 (21.8)	0.37 (9.5)	0.53 (13.5)	VUK-11PAM
				1.96 (49.8)	0.98 (24.9)					VUK-11PBM
	3/8		0.252 (6.4)	2.25 (57.2)	1.12 (28.4)	3.56 (90.4)	1.06 (26.9)	0.5 (12.7)	0.66 (16.8)	VUK-11PCM
Female NPT	1/8		0.126 (3.2)	1.63 (41.4)	0.81 (20.6)	2.81 (71.4)	0.86 (21.8)	0.37 (9.5)	0.53 (13.5)	VUK-11PAN
	1/4		0.252 (6.4)	2.12 (53.8)	1.06 (26.9)	3.56 (90.4)	1.06 (26.9)	0.5 (12.7)	0.66 (16.8)	VUK-11PBN
Male NPT	1/8	0.126 (3.2)	1.72 (43.7)	0.86 (21.8)	2.81 (71.4)	0.86 (21.8)	0.37 (9.5)	0.53 (13.5)	VUK-11PANM	
			1.96 (49.8)	0.98 (24.9)					VUK-11PBNM	
	3/8	0.252 (6.4)	2.25 (57.2)	1.12 (28.4)	3.56 (90.4)	1.06 (26.9)	0.5 (12.7)	0.66 (16.8)	VUK-11PCNM	

Dimensions

Angle Type

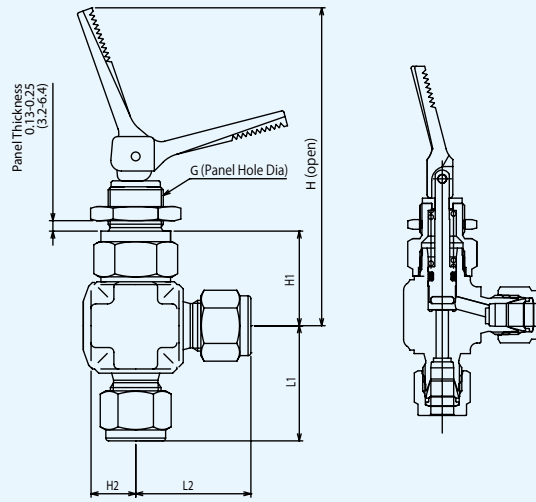

Connection Types	Nominal Diameter inch (mm)	Operating Pressure psi (bar)	Orifice inch (mm)	Dimensions inch (mm)					Ordering Numbers	
				L1	L2	H	H1	H2		G
V-Lok	1/4 (-)	200 (137)	0.13 (3.2)	1.13 (28.7)		2.81 (71.4)	0.86 (21.8)	0.37 (9.5)	0.53 (13.5)	VUK-01P-6.35
	3/8 (-)		0.25 (6.4)	1.29 (32.8)		3.56 (90.4)	1.06 (26.9)	0.5 (12.7)	0.66 (16.8)	VUK-01P-9.52
	1/2 (-)			1.4 (35.6)						VUK-01P-12.7
	- (6)		0.13 (3.2)	1.13 (28.7)		2.81 (71.4)	0.86 (21.8)	0.37 (9.5)	0.53 (13.5)	VUK-01P-6
	- (8)			1.11 (28.2)						VUK-01P-8
	- (10)		0.25 (6.4)	1.36 (34.5)		3.56 (90.4)	1.06 (26.9)	0.5 (12.7)	0.66 (16.8)	VUK-01P-10
	- (12)			1.46 (37.1)						VUK-01P-12
Rc	1/8		0.13 (3.2)	0.81 (20.6)		2.81 (71.4)	0.86 (21.8)	0.37 (9.5)	0.53 (13.5)	VUK-31PA
	1/4		0.25 (6.4)	1.06 (26.9)		3.56 (90.4)	1.06 (26.9)	0.5 (12.7)	0.66 (16.8)	VUK-31PB
Rc	1/8		0.13 (3.2)	0.86 (21.8)		2.81 (71.4)	0.86 (21.8)	0.37 (9.5)	0.53 (13.5)	VUK-31PAM
				0.98 (24.9)						VUK-31PBM
	3/8		0.25 (6.4)	1.12 (28.4)		3.56 (90.4)	1.06 (26.9)	0.5 (12.7)	0.66 (16.8)	VUK-31PCM
Female NPT	1/8		0.13 (3.2)	0.81 (20.6)		2.81 (71.4)	0.86 (21.8)	0.37 (9.5)	0.53 (13.5)	VUK-31PAN
	1/4		0.25 (6.4)	1.06 (26.9)		90.4	1.06 (26.9)	0.5 (12.7)	0.66 (16.8)	VUK-31PBN
Male NPT	1/8	0.13 (3.2)	0.86 (21.8)		2.81 (71.4)	0.86 (21.8)	0.37 (9.5)	0.53 (13.5)	VUK-31PANM	
			0.98 (24.9)						VUK-31PBNM	
	3/8	0.25 (6.4)	1.12 (28.4)		3.56 (90.4)	1.06 (26.9)	0.5 (12.7)	0.66 (16.8)	VUK-31PCNM	

Ordering Information

VUK
①②③

—

91PA
④⑤⑥⑦

—

6.35
⑧

① Valve Series

② Body Material
Stainless Steel

③ Valve Type
Toggle Valves

④ End Connections

0 : **V-Lok** Type (Angle Type)
1 : Thread Type (Globe Type)
3 : Thread Type (Angle Type)
9 : **V-Lok** Type (Globe Type)

⑤ Working Pressure
200psig (1.37 bar)

⑥ Panel Nut

⑦ Connection1
A : Rc1/8
B : Rc1/4
Blank : **V-Lok** Type

⑧ Connection Sizes

Blank : Thread Type
6 : **V-Lok** 6
8 : **V-Lok** 8
10 : **V-Lok** 10
12 : **V-Lok** 12
6.35 : **V-Lok** 1/4
9.52 : **V-Lok** 3/8
12.7 : **V-Lok** 1/2



Features

1. Service up to 6000 psig (413 bar)
2. By 8 kinds of springs for Nominal Size 1/4, possible to set the cracking pressure for your request
3. By 3 kinds of springs for Nominal Size 1/2, possible to set the cracking pressure for your request

Technical Data

Working Pressure

		Nominal Sizes inch(mm)	
		1/4 (6.35)	1/2 (12.7)
Working pressure at 70 °F (20 °C)		6000 psig (413 bar): up to 8000 psig (551 bar) during relief	6000 psig (413 bar)
Set Pressure	※ 1	50 to 6000 psig (3.4 to 413 bar)	50 to 1500 psig (3.4 to 103 bar)
Outlet pressure	※ 2	1500 psig (103 bar)	2500 psig (172 bar)
Seat Material		FKM, Chloroprene Rubber, Kalrez®	FKM, Chloroprene Rubber, Kalrez®

- ※ 1: Please confirm the maximum setting pressure in each temperature from the Temperature and Pressure Rating. The pressure-temperature ratings are based upon laboratory testing to ensure that the cracking pressure (※ 3) does not deviate by more than 20 % from the Initial room-temperature set pressure.
- ※ 2: Outlet pressure should not exceed Inlet pressure.
- ※ 3: Cracking pressure means the inlet pressure at the time of showing the indication of the flow starting. The flow starting indicates the flow level that bubbles are generated continuously from outlet piping in the water, when pressurizing from inlet piping.

Temperature and Pressure Rating

Seat Materials: FKM, Kalrez®

Nominal Size: 1/4 in. (6.35)

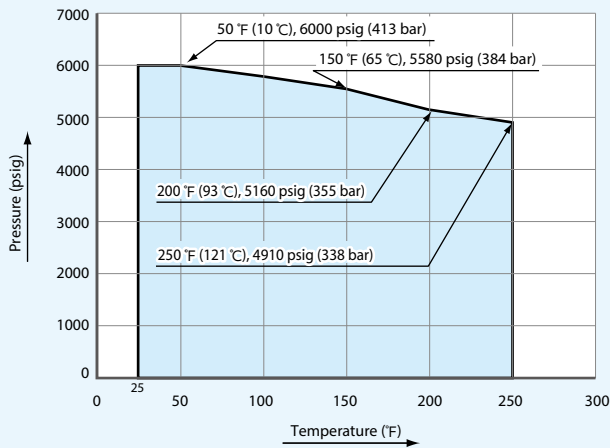

Nominal Size: 1/2 in. (12.7)

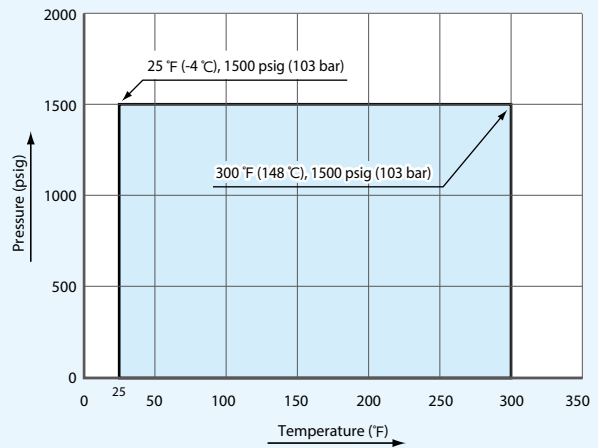

Seat Material: Chloroprene Rubber

Nominal Size: 1/4 in. (6.35)

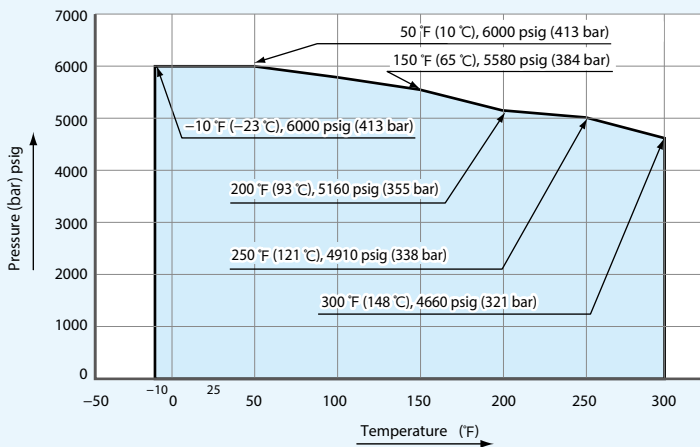

Nominal Size: 1/2 in. (12.7)

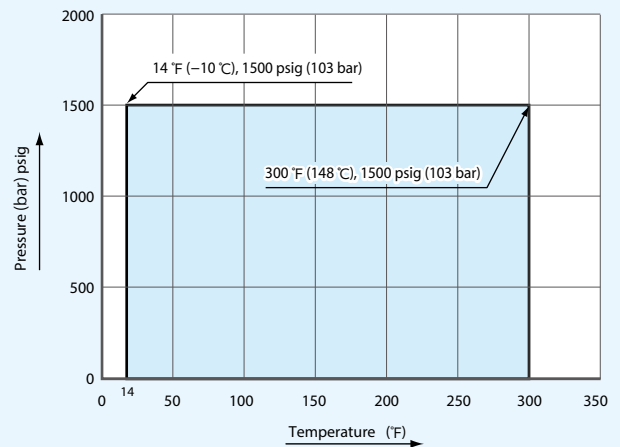

Applicable Fluid

Air, Nitrogen gas, Inert gas like Helium, and non-corrosive gas and Liquid.

Attention and asking in selection

1. The spring isn't built in the valve, so please order the spring kit separately. (Please refer to the P.176 "Ordering Information")
2. This product opens gradually as the pressure increases. There is no designated capacity rating at a given pressure (accumulation), therefore, the product does not confirm to ASME standard or any other standards.
3. A higher relief pressure than the set pressure may be required for opening the product initially, when the product is not in use for a long period of time.
4. This product is a relief valve, therefore, do not use it as a safety valve.

Materials of Construction

Nominal size: 1/4 in. (6.35)

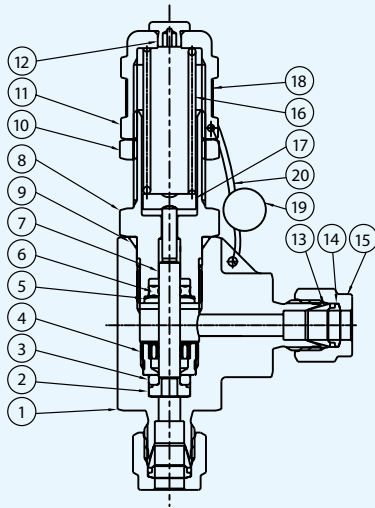

No.	Description	Materials
1	BODY ※ 1	ASTM A182 F316
2	INSERT ※ 1	ASTM A479 316
3	O-RING ※ 1	FKM ※ 3
4	SEAT RETAINER ※ 1	ASTM A479 316
5	RETAINER ※ 1	SUS304
6	X-RING ※ 1	FKM ※ 3
7	STEM ※ 1	ASTM A479 316
8	BONNET ※ 1	ASTM A479 316
9	O-RING ※ 1	FKM ※ 3
10	LOCK NUT	ASTM A276 316

No.	Description	Materials
11	CAP	ASTM A479 316
12	PLUG	NYLON6
13	FRONT RING ※ 1	ASTM A276 316
14	BACK RING ※ 1	ASTM A276 316
15	NUT	ASTM A276 316
16	SPRING ※ 2	SUS631
17	SPRING SUPPORT ※ 2	ASTM A276 316
18	LABEL ※ 2	PET
19	CORD SEAL ※ 2	Pb
20	WIRE ※ 2	SUS304-W1

- ※ 1: Wetted Part
- ※ 2: Parts of No.16-20 aren't built in the valve. Please order the spring kit of another sales separately. (Please refer to P.176 "Ordering Information")
- ※ 3: Available Chloroprene Rubber, Kalrez® for option.

Nominal size: 1/2 in. (12.7)

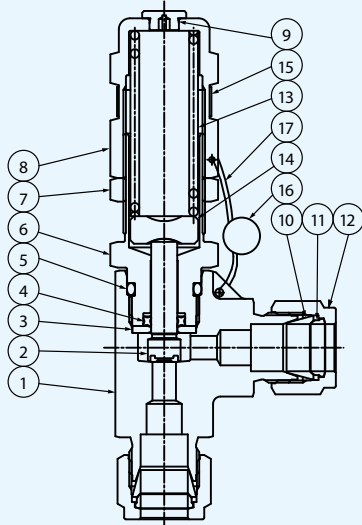

No.	Description	Materials
1	BODY ※ 1	ASTM A182 F316
2	STEM ※ 1	ASTM A479 316+FKM
3	RETAINER ※ 1	ASTM A479 316
4	X-RING ※ 1	FKM ※ 3
5	O-RING ※ 1	FKM ※ 3
6	BONNET ※ 1	ASTM A479 316
7	LOCK NUT	ASTM A276 316
8	CAP	ASTM A479 316
9	PLUG	NYLON 6

No.	Description	Materials
10	FRONT RING ※ 1	ASTM A276 316
11	BACK RING ※ 1	ASTM A276 316
12	NUT	ASTM A276 316
13	SPRING ※ 2	SUS631
14	SPRING SUPPORT ※ 2	ASTM A276 316
15	LABEL ※ 2	PET
16	CORD SEAL ※ 2	Pb
17	WIRE ※ 2	SUS304-W1

- ※ 1: Wetted Part
- ※ 2: Parts of No.13-17 aren't built in the valve. Please order the spring kit of another sales separately. (Please refer to P.176 "Ordering Information")
- ※ 3: Available Chloroprene Rubber, Kalrez® for option.

Dimensions

Standard Type

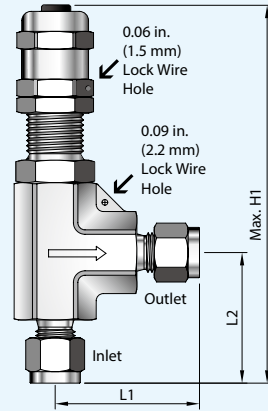

with Pressure Relief Handle Type

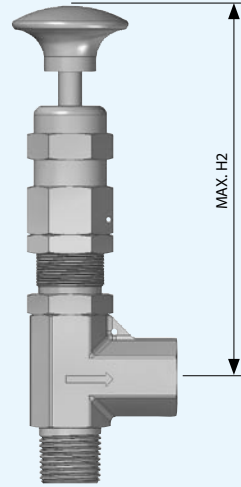

Nominal Size: 1/4 Type

End Connection Inlet/Outlet	Nominal Sizes	Working Pressure psig (bar)	Orifice inch (mm)	Dimensions inch (mm)				Ordering Numbers
				L1	L2	H	H2	
V-Lok	1/4 (6.35)	6000 (413)	0.14 (3.6)	1.6 (40.6)	1.44 (36.6)	4.13 (105)	4.09 (104)	VURF-041L-6.35
NPT ※	1/4			1.17 (29.7)	1.19 (30.2)	3.89 (98.8)		VURF-341LBNM×BNF

Nominal Size: 1/2 Type

End Connection Inlet/Outlet	Nominal Sizes	Working Pressure psig (bar)	Orifice inch (mm)	Dimensions inch (mm)				Ordering Numbers
				L1	L2	H	H2	
V-Lok	1/2 (12.7)	6000 (413)	0.252 (6.4)	1.83 (46.5)	1.83 (46.5)	5.91 (150)	5.35 (136)	VURF-041L-12.7
NPT ※	1/2			1.43 (36.3)	1.43 (36.3)	5.51 (140)		VURF-341LDNM×DNF

※ : Inlet: Male, Outlet: Female

Ordering Information

Relief Valves

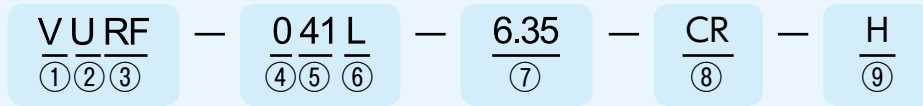

Spring kit

Set Pressure psig(bar)	Spring Color	Ordering Numbers
Nominal Sizes 1/4 in.		
50-350 psig (3.4-24.1bar)	Blue	SK-VURF-6.35-A
350-750 psig (24.1-51.7bar)	Yellow	SK-VURF-6.35-B
750-1500 psig (51.7-103bar)	Purple	SK-VURF-6.35-C
1500-2250 psig (103-155bar)	Orange	SK-VURF-6.35-D
2250-3000 psig (155-206bar)	Brown	SK-VURF-6.35-E
3000-4000 psig (206-275bar)	White	SK-VURF-6.35-F
4000-5000 psig (275-344bar)	Red	SK-VURF-6.35-G
5000-6000 psig (344-413bar)	Green	SK-VURF-6.35-H
Nominal Sizes 1/2 in.		
50-350 psig (3.4-24.1bar)	Blue	SK-VURF-12.7-A
350-750 psig (24.1-51.7bar)	Yellow	SK-VURF-12.7-B
750-1500 psig (51.7-103bar)	Purple	SK-VURF-12.7-C

- ① Valve Series
- ② Body Material
Stainless Steel
- ③ Valve Type
Relief Valves
- ④ End Connections
V-Lok, Angle Type
- ⑤ Working Pressure
6000 psig (413 bar)
- ⑥ Lock Nut
- ⑦ Connection Sizes
6.35 : V-Lok 1/4 in.
12.7 : V-Lok 1/2 in.
BNM × BNF : 1/4 in. (NPT)
Inlet: Male Pipe
Outlet: Female Pipe
DNM × DNF : 1/2 in. (NPT)
Inlet: Male Pipe
Outlet: Female Pipe
- ⑧ Seal Material
Blank : FKM (Standard)
CR : Chloroprene Rubber
KA : FFKM ※
- ⑨ Blank : Standard
H : with Pressure Relief Handle Type

※ : Getting ready. Begin to sell it soon.

Factory-Set Relief Valves

Relief valves are available with springs factory-set to a special set pressure. Valves are set, tested locked, and stuck a label with the set pressure. Inspection certificate is also attached.

To order, add the alphabet A-H of Ordering Numbers whose includes the desired set pressure to the valve ordering number; specify the desired set pressure.

Example: VURF-041L-6.35-A

Features

Fixed Cracking Pressures

From 1/3 to 25 psi (0.03 to 1.8 bar) (Standard: 1 psig)



Technical Data

Temperature and Pressure Rating

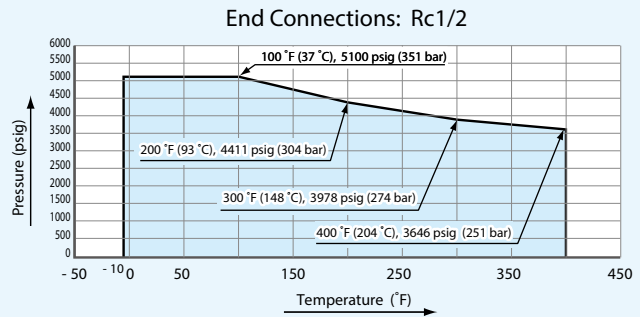
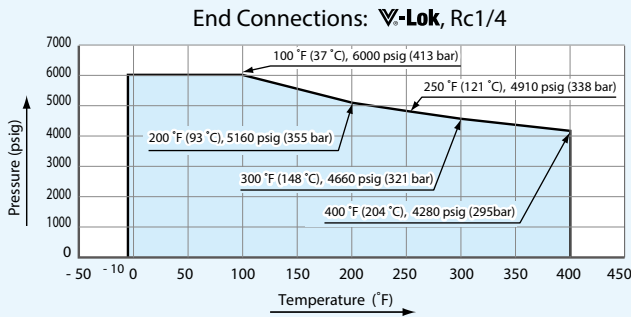

Cracking and Reseal Pressures at 70 °F (20 °C)

Nominal Cracking Pressure psig (bar)	Cracking Pressure Range psig (bar) ※1	Reseal Pressure psig (bar) ※2
1/3 (0.03)	Up to 3 (0.21)	Up to 6 (0.42) back pressure
1 (0.07)	Up to 4 (0.28)	Up to 5 (0.35) back pressure
5 (0.35)	3 to 9 (0.21 to 0.63)	Up to 2 (0.14) back pressure
10 (0.69)	7 to 15 (0.49 to 1.1)	3 (0.21) or more upstream pressure
25 (1.8)	20 to 30 (1.4 to 2.1)	17 (1.2) or more upstream pressure

※ 1: **Cracking Pressure:**
The upstream pressure at which the first indication of flow occurs.
※ 2: **Reseal Pressure:**
The pressure at which there is no indication of flow.

Applicable Fluid

Air, Nitrogen gas, Inert gas like Helium, and non - corrosive gas and liquid.

Attention and asking in selection

1. For valves not actuated for a period of time, initial cracking pressure may be higher than the set cracking pressure.
2. In general Check Valves are used for only direction control of flow. Please don't use Check Valves for ON - OFF Valves and Relief Valves.

Materials of Construction

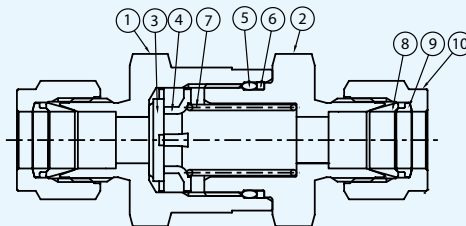

No.	Description	Materials	No.	Description	Materials
1	BODY1	※ ASTM A479 316	6	BACKUP RING	PTFE
2	BODY2	※ ASTM A479 316	7	SPRING	※ SUS316
3	POPPET	※ SUS 316L + FKM	8	FRONT RING	※ ASTM A276 316
4	POPPET STOP	※ ASTM A276 316	9	BACK RING	※ ASTM A276 316
5	O-RING	※ FKM	10	NUT	ASTM A276 316

※ : Wetted Part

Dimensions

Dimensions, shown with **V-Lok** tube fitting nuts finger-tight, are for reference only and are subject to change.

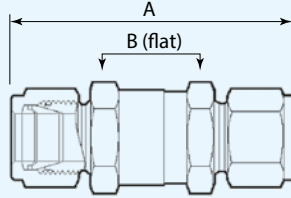

End Connections	Nominal Sizes inch (mm)	Working Pressure psig (bar)	Dimensions inch (mm)		Cracking Pressure psig (bar)	Ordering Numbers
			A	B		
V-Lok	1/4 (6.35)	6000 (413)	2.43 (61.7)	11/16 (17.5)	1 (0.07) ※1	VUCL-941-6.35-0.07
	3/8 (9.52)		2.75 (69.9)	1 (25.4)		VUCL-941-9.52-0.07
	1/2 (12.7)		2.96 (75.2)			VUCL-941-12.7-0.07
	— (6)		2.43 (61.7)	11/16 (17.5)		VUCL-941-6-0.07
	— (8)		2.7 (68.6)	1 (25.4)		VUCL-941-8-0.07
	— (10)		2.8 (71.1)			VUCL-941-10-0.07
	— (12)		2.96 (75.2)			VUCL-941-12-0.07
Rc	1/4	5100 (351)	2.28 (57.9)	11/16 (17.5)		VUCL-141B-0.07
	1/2		3.29 (83.6)	1-1/16 (27)		VUCL-141D-0.07
Female NPT	1/4	6000 (413)	2.13 (54.1)	11/16 (17.5)		VUCL-141BN
	3/8	5300 (365)	2.55 (64.8)	1 (25.4)		VUCL-141CN
	1/2	4896 (337)	3.03 (77)	1-1/16 (27)		VUCL-141DN
Male NPT	1/8	6000 (413)	1.79 (45.5)	11/16 (17.5)		VUCL-141ANM ※
	1/4		2.17 (55.1)		VUCL-141BNM ※	
	3/8		2.36 (59.9)	1 (25.4)	VUCL-141CNM ※	
	1/2		2.73 (69.3)		VUCL-141DNM ※	

※ : Getting ready. Begin to sell it soon.

Ordering Information

VUCL — 941 — 6.35 — 0.07
 ①②③ ④⑤ ⑥ ⑦

- ① Valve Series
 - ② Body Material
Stainless Steel
 - ③ Valve Type
Check Valves
 - ④ End Connections
1: Thread Type
9: **V-Lok** Type
 - ⑤ Working Pressure
6000 psig (413 bar)
 - ⑥ Connection Sizes
6.35: **V-Lok** 6.35
9.52: **V-Lok** 9.52
12.7: **V-Lok** 12.7
6: **V-Lok** 6
8: **V-Lok** 8
10: **V-Lok** 10
12: **V-Lok** 12
 - ⑦ Cracking Pressures
0.07: 1 psig (0.07 bar)
0.03: 1/3 psig (0.03 bar)
0.35: 5 psig (0.35 bar)
0.69: 10 psig (0.69 bar)
1.8: 25 psig (1.8 bar)
- B: Rc1/4
D: Rc1/2
BN: 1/4in. Female NPT
CN: 1/8in. Female NPT
DN: 1/2in. Female NPT
ANM: 1/8in. Male NPT
BNM: 1/4in. Male NPT
CNM: 3/8in. Male NPT
DNM: 1/2in. Male NPT

Other Related Products

Automatic Flow Control Valve Series

Diaphragm Type Mini Control Valves MINUCON Series

Electric Valves SR100 Series

Electric Valves SR100E Series

Electric Valves AR2000 Series

Electric Valves SR100M Series

Others

FINE BUBBLE Leak Detection Fluid

MINUCON

MINUCON is the pneumatic operating control valves which concentrated the aggregate power of this craftsmanship of **Fujikin** and was manufactured.

The precision of control and the certainty of the operation are suitable for precise flow control of various kinds of research experiments, process lines, etc.

Wide Cv Value selection range 0.0000015 - 5 is available.

Features

The High Sensitivity Diaphragm Type Actuator

Realizes outstanding control performance

Compact Design

Adopted the multi - spring system (M3 Type)



Close Control Hysteresis

1.5 % or less is realized by adoption of a positioner. (Less than 0.00025 Cv Value is less than hysteresis 2 %.)

The material of Disc & Seat is SUS316+Stellite cladding, and is excellent against abrasion.

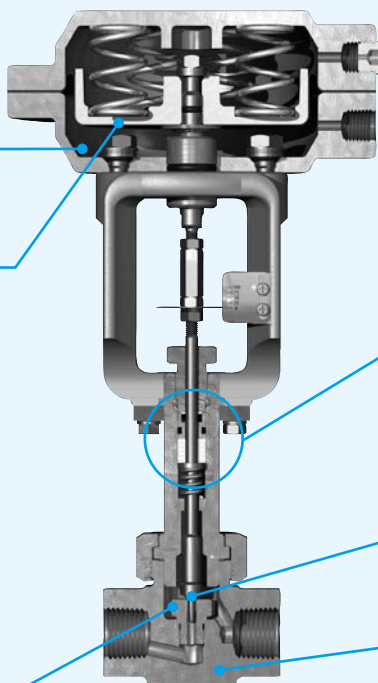

Double Seal Structure

A gland part is the double seal structure of the gland packing made from PTFE, and O-Rings made of fluorocarbon rubber.

Wide Cv Value Selection Range

Stem & Disk are made by SUS316+Stellite cladding, excellent for against abrasion. Wide range of Cv Value available, 0.0000015 to 5. ※

Body made from forged Stainless steel body (SUSF316) ※

※ ASTM standard (equivalent to SUS316 & SUS304) may be used instead of SUS316 & SUS304 materials.

Application

- Various Research / Experiment Equipment
- Precise Fluid Control of Process Line
- For flow control of Calorie Meter Coolant

SR100

SR100 is the electronic valve which concentrated the aggregate power of this craftsmanship of **Fujikin** and was manufactured. Adoption of the stepping motor excellent in position accuracy realized the high-speed response, close control, and high resolution which are not in the conventional electric motor valve. Wide Cv Value selection range 0.0000015 – 5 is available. **Fujikin** satisfy flexibly the demand of all precise flow control of various kinds of research experimental devices, a process line, etc.

Features

Close Controlability

A high precision sensor is built in, By feeding back valve travel, close control, excellent in reproducibility and hysteresis characteristics is realized!

Wide Cv Value Selection Range

Stem & Disk are made by SUS316 + Stellite cladding, excellent against abrasion. ※
Wide range of Cv Value available, 0.0000015 to 5.

Body made from forged Stainless Steel (SUSF316) ※

※ ASTM standard (equivalent to SUS316 & SUS304) may be used instead of SUS316 & SUS304 materials.

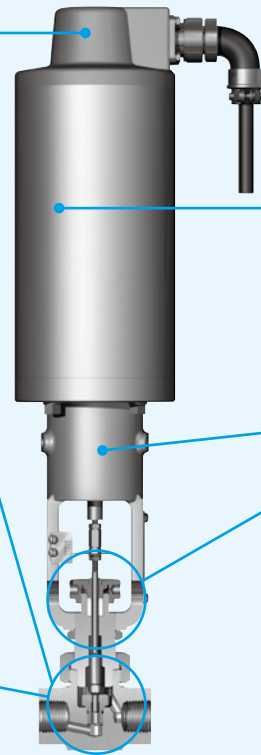

Special Proportional Solenoid Actuator

By adopting special proportional solenoid as a drive source, the high - speed response was realized as the time from full open to close is 0.6 sec or less. (normal open type: 0.8 sec or less)

Spring Back Structure

Since SR100 has a spring back structure, in an emergency, the valve operates in full open or a closed position.

PTFE Gland Packing

Drive Unit

If an electric signal 4 – 20mA is inputted into a drive unit for exclusive use, the valve will operate to predetermined valve travel.



Application

- Cogeneration • For fuel control of generator
- For flow control of Calorie Meter Coolant
- For pressure control in the evaluation equipment of fuel cell
- For the equipment which cannot install the source of air

SR100E

SR100E is the electric flow control valve which has excellent performance in position accuracy, the high speed response, close control, and high resolution.

Features

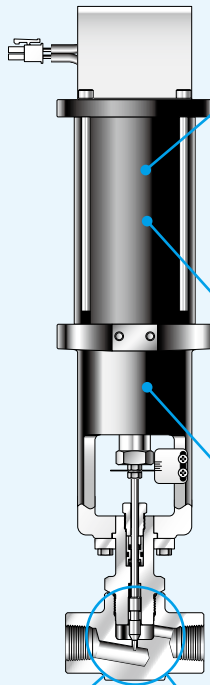

1. High Speed Response

By adopting special solenoid as a drive source, the high speed response was realized as the time from full open to close is 0.3 sec or less. It's excellent compared with air operate and motor drive valve.

Open / Close Time (sec)	approximately 0.3 (One way)
Resolution	500 : 1
Hysteresis (%)	1.5 or less

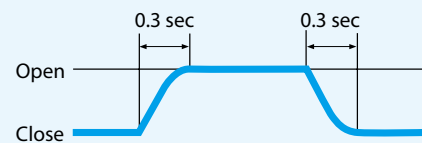

2. Close Controllability

A high precision sensor is built in, By feeding back valve travel, close control, excellent in reproducibility and hysteresis characteristics is realized!

3. Spring Back Structure

Since SR100E has a spring back structure, in an emergency, the valve operates in full open or a closed position.

5. Input Signal

DC 4 – 20 mA
DC 1 – 5 V

6. Air Source Unnecessary

7. Compact Design

30% compact than SR100
60% light weight than SR100

Body made from forged Stainless Steel (SUSF316) ※

※ ASTM standard (equivalent to SUS316 & SUS304) may be used instead of SUS316 & SUS304 materials.

4. Wide Cv Value Selection Range

Stem & Disk are made by SUS316 + Stellite cladding, excellent against abrasion. ※

Wide range of Cv Value available, 0.0000015 to 5.

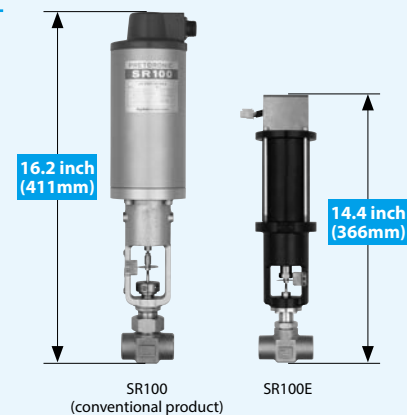

Application

- Cogeneration • For fuel control of generator
- For flow control of Calorie Meter Coolant
- For pressure control in the evaluation equipment of fuel cell
- For the equipment which cannot install the source of air

AR2000

AR2000 is the electronic valve which concentrated the aggregate power of this craftsmanship of **Fujikin** and was manufactured. Adoption of the stepping motor excellent in position accuracy realized the high-speed response, close control, and high resolution which are not in the conventional electric motor valve. Wide Cv Value selection range 0.0000015 – 5 is available.

Features

Wide Cv Value Selection Range

Stem & Disk are made by SUS316 + Stellite cladding, excellent against abrasion.

Wide Cv Value range available, 0.0000015 to 5. ※



Drive Unit

If an electric signal 4 – 20mA is inputted into a drive unit for exclusive use, the valve will operate to predetermined valve travel.

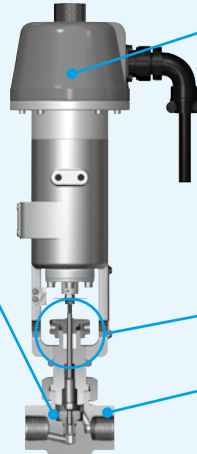

Resolution: 2000: 1

High resolution by adopting stepping motor driven actuator.

Explosion – proof model is also available

d2G4 explosion – proof type actuator is available.

PTFE Gland Packing

Body made from forged Stainless Steel (SUSF316) ※

※ ASTM standard (equivalent to SUS316 & SUS304) may be used instead of SUS316 & SUS304 materials.

Application

- Cogeneration For fuel control of generator
- For flow control of Calorie Meter Coolant
- For pressure control in the evaluation equipment of fuel cell
- For the equipment which cannot install the source of air
- For flow control of a compressed natural gas automobile filling machine

SR100M

SR100M is the ultra compact electric valve which concentrated the aggregate power of this craftsmanship of **Fujikin**, was manufactured, and has united drive unit and actuator.

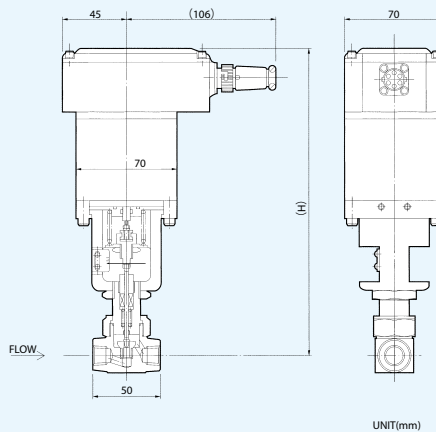





Features

1. High Speed Operation
2. Spring Back Structure
3. Compact Design
compact & Lightweight
4. Air Source Unnecessary
5. Input Signal
DC 4 – 20 mA
DC 1 – 5 V
6. Feed Back Mechanism



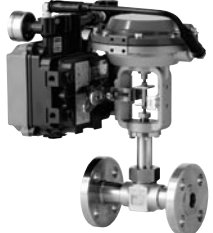

Application

- Hyperbaric Oxygen Therapy
- Micro Reactor

Automatic Flow Control Valves

Product Series	MINUCON					
	Type	ON-OFF Type	without Positioner Type	with E/P SAMSON Positioner Type	with E/P SSS Positioner Type	wirh P/P SIEMENS Positioner Type
Outlook						
Signal	–	20 – 100 kPa	4 – 20 mA DC		20 – 100 kPa	
Electric Source	–					
Supply Pressure (kPa)	100 / 200 / 400	–	140 / 240 / 400			
Hysteresis (%)	–	15 or less	1.5% or less			
Full Open to Close Time (sec)	–	–	3 or less (One way) 140kPa 2 or less (One way) 240kPa 1 or less (One way) 400kPa	140kPa → 13 or below (One way) 240kPa → 12 or below (One way) 400kPa → 9 or below (One way)	–	
Resolution / Stroke (mm)	–	–	850 (M2 Type) 1000 (M3 Type)	350 (M2, M3 Type)	–	
Range-ability	–	20 : 1 (standard) available to 100 : 1				
Rated Cv Value	0.25 – 5	0.01 – 5	0.0000015 – 5			
Max. Opr. Pres. (MPa)	14.7 / 29.4 / 49	14.7	14.7 / 29.4 / 49			
Fluid Temperature (°C)	–50 – +150 (Standard Type) –50 – +230 (C-PTFE Gland Packing Type) –50 – +500 (High Temperature Type) –253 – +150 (Low temperature Type)	–50 – +150	–50 – +150 (Standard Type) –50 – +230 (C-PTFE Gland Packing) –50 – +500 (High temperature Type) –253 – +150 (Low temperature Type)			
Explosion Proof	–	–	II 2G EEx d IICT6 (ATEX) Pressure / Explosion Proof Ex II 2G EEx ia IICT6 (ATEX) Intrinsically Safe Explosion Proof	Exd II BT6(Pressure / Explosion Proof) Exd II B+H2T6(Pressure – resistant & Explosion Proof for Hydrogen)	–	
Actuator Type	Diaphragm					
Operating Type	N.O. / N.C.					
Failure Position	Full Open / Full Close					
Cable Connection	–	Terminal Box			–	
Height (mm)	250	250	270	380		
Weight (Kg)	2.5	4.5	6	–		
Features	Minutes Flow Control Valves for High Pressure					
Applications	Pressure control for calorie meters / High degree of purity nitrogen refinement equipment Hydrogen producing device / Hydrogen and oxygen supply installation Hydrogen absorbing alloys evaluation equipment / Ammonia supply equipment Pressure control for carbonic acid gas super-criticality / Oxygen gas filling equipment Flow control & pressure control					

Automatic Flow Control Valves

Product Series	SR100		SR100E	AR2000				SR100M
	S2	S3	—	C1	C3	C1E	C3E	—
Outlook								
Signal	DC4 – 20mA / DC1 – 5V / DC1 – 10V			DC4 – 20mA / DC1 – 5V / DC1 – 10V				DC4 – 20mA / DC1 – 5V / DC1 – 10V
Electric Source	AC100V (85 – 132V) DC24V ±10%(2.1A)		DC24V±10% (2.1A)	DC24V±10% (2.4A)	DC24V±10% (3.4A)	DC24V±10% (2.4A)	DC24V±10% (3.4A)	DC24V±10% 2.1A(2.4A)
Supply Pressure (kPa)	—							
Hysteresis (%)	1.5 or less		1.5 or less	1.5 or less (Actual : 0.1 or less)				3.0 or less
Full Open to Close Time (sec)	0.6 or less (F.S. 8mm) 1 or less (N.O. Type)		Approx 0.3	1.7 or less				0.5 or less
Resolution / Stroke (mm)	500 : 1 / 8		500 : 1 / 5	約 2000 : 1 / 8				200 : 1 / 4
Range-ability	20 : 1 (Standard) 100 : 1 (Option)		20 : 1	20 : 1 (Standard) 100 : 1 (Option)				20 : 1
Rated Cv Value	0.01 – 5	0.0000015 – 5	0.0000015 – 5	0.0000015 – 5				0.01 – 0.5
Max. Opr. Pres. (MPa)	14.7		1	14.7 / 29.4 / 49				2.94
Fluid Temperature (°C)	–50 – +150 (Standard Type) –50 – +230 (C-PTFE Gland Packing Type) –50 – +500 (High Temp. Type) –253 – +150 (Low Temp. Type)		–20 – 150°C	–50 – +150 (Standard Type) –50 – +230 (C-PTFE Gland Packing Type) –50 – +500 (High Temp. Type) –253 – +150 (Low Temp. Type)				–10 – 150°C
Explosion Proof	NON			NON	d2G4 (Pressure / Explosion Proof)			—
Actuator Type	Proportional Solenoid			Stepping Motor				Proportional Solenoid
Operating Type	N.O / N.C		N.C	Signal to open				N.O / N.C
Failure Position	Full Open / Full Close		Full Close	keeping as				Full Open / Full Close
Cable Connection	Connector / Terminal Block		Connector ※ with control cable 1m	Connector		Terminal Block		Connector
Height (mm)	440	460m	370	340	390	430	490	230
Weight (Kg)	11 Drive Unit: 1	18 Drive Unit: 1	5 Drive Unit: 0.3	4 Drive unit:1	5 Drive unit:1	—	—	3.5 United Drive Unit and Actuator
Features	High Speed Response		High Speed Response Good Cost Performane	High Resolution for High Pressure				High Speed Response United Drive Unit and Actuator
Applications	Pressure control for calorie meters / Control for refrigeration machine of refrigerating installation / Air pressure control for low pressure casting machine / Fuel control for Gas turbine / Small gas turbine Fuel control / Flow control for NOx reduction water injection / Fuel cell evaluation units		For water supply equipment / Fuel control for Gas turbine	Fuel control for Gas turbine / Small gas turbine Fuel control / Pressure control for calorie meters / Pressure control for injection checks / Flow rate control for compressed natural gas dispensers / Flow rate control for resin production units / Pressure control for carbonic acid gas super- criticality / Oxygen gas filling equipment				For cold control systems / Cultivation Tank / Airflow control valve / Flow rate control for high-pressure oxygen treatment machines

FINE BUBBLE Leak Detection Fluid

Concentration of Impurities (Units: ppm)

Impurities	Na	K	Ca	Cl	F
Concentration	<1	<1	<1	<1	<1

Ordering No.	Container Size	Quantity per Pack	Container
LL-S-1	60mL	6 bottles/pack	Squeeze bottle
LL-M-1	300mL	1 bottle/pack	Squeeze bottle with nozzle cap
LL-L-1	4 L	1 container/pack	Refill container



60mL

300mL

4 L

Note: Materials and dimension are subject to change without notice.

Features

- With its viscosity and rapid foaming action, FINE BUBBLE detects the smallest leaks even when it is applied in small amounts.
- Noncorrosive; does not react with metal, coatings, rubber, or plastic surfaces.
- Dries clean and without staining.
- Minimal impurities such as sodium, potassium, calcium, chlorine, fluorine, bromine, and sulfur compounds.
- Nonflammable; does not react with oxygen.
- Available in three convenient sizes: 60mL (squeeze bottle), 300mL (squeeze bottle with nozzle cap), and 4L (refill container).
- Read the instructions carefully before use.

FINE BUBBLE Test Data

Corrosion Test Results

Tube Material (25 x 50 x 15t #400 finish)	Leak Detection Fluid			
	FINE BUBBLE	Brand B	Brand C	Duration
S55C	○	X3	X3	24 hours
A1050P	○	○	△ ₁₂₀	120 hours
C2801P	△ ₃	△ ₃	△ ₃	120 hours
SUS304	○	○	○	120 hours

Key: ○: Almost no changes at the end of the test

△: Discolored or slightly corroded

x: Corroded

* Numbers next to the icon indicate when (in terms of hours) changes to the metal were visually observed.

Immersion Corrosion Test

The metal samples were immersed in the leak detection fluids at 30°C and inspected for changes.

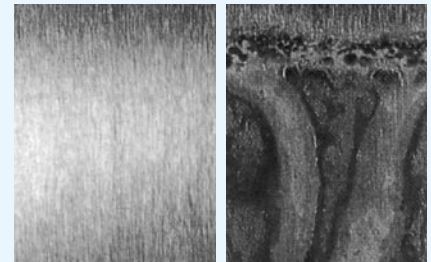

FINE BUBBLE

Brand B

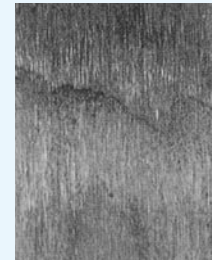

Brand C

S55C samples after 24 hours of immersion in the leak detection fluids

The contents of the description are reference, and are subject to change without notice.



Technical Data

V-Lok Tube Fittings PERFORMANCE CONFIRMATION TEST RESULTS

CERTIFICATE **V-Lok** Tube Fittings



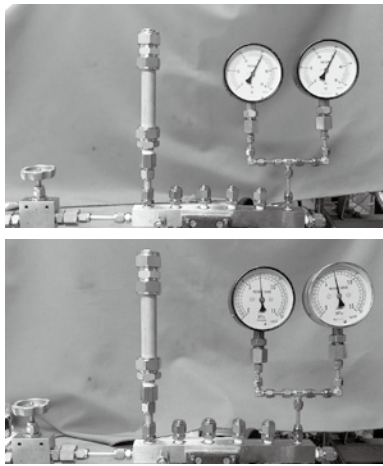
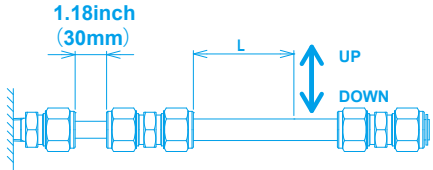
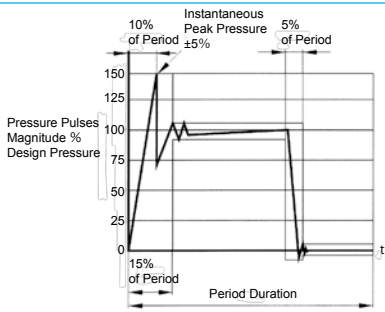

REMARKS Special Materials
Oil-free Products

1. V-Lok PERFORMANCE CONFIRMATION TEST RESULTS (1/3)

Test Items	Test Conditions & Landscape		Results																	
Tightness Test	<table border="1"> <thead> <tr> <th>Test Fluid</th> <th>Nominal Dia. inch(mm)</th> <th>Test Pres. (MPa)</th> </tr> </thead> <tbody> <tr> <td rowspan="3">H₂O</td> <td>1/8(3.2)</td> <td>45</td> </tr> <tr> <td>1/2(12.7)</td> <td>45</td> </tr> <tr> <td>1(25.4)</td> <td>30</td> </tr> <tr> <td rowspan="3">Air</td> <td>1/8(3.2)</td> <td>7</td> </tr> <tr> <td>1/2(12.7)</td> <td>7</td> </tr> <tr> <td>1(25.4)</td> <td>7</td> </tr> </tbody> </table>	Test Fluid	Nominal Dia. inch(mm)	Test Pres. (MPa)	H ₂ O	1/8(3.2)	45	1/2(12.7)	45	1(25.4)	30	Air	1/8(3.2)	7	1/2(12.7)	7	1(25.4)	7		good (No Leakage)
	Test Fluid	Nominal Dia. inch(mm)	Test Pres. (MPa)																	
H ₂ O	1/8(3.2)	45																		
	1/2(12.7)	45																		
	1(25.4)	30																		
Air	1/8(3.2)	7																		
	1/2(12.7)	7																		
	1(25.4)	7																		
Retaining Period: 5 minutes																				
Vibration (Fatigue) Test	<table border="1"> <thead> <tr> <th>Test Fluid</th> <th>Nominal Dia. inch(mm)</th> <th>Test Pres. (MPa)</th> </tr> </thead> <tbody> <tr> <td rowspan="3">Oil</td> <td>1/8(3.2)</td> <td>30</td> </tr> <tr> <td>1/2(12.7)</td> <td>30</td> </tr> <tr> <td>1(25.4)</td> <td>20</td> </tr> </tbody> </table>	Test Fluid	Nominal Dia. inch(mm)	Test Pres. (MPa)	Oil	1/8(3.2)	30	1/2(12.7)	30	1(25.4)	20		good (No Leakage)							
	Test Fluid	Nominal Dia. inch(mm)	Test Pres. (MPa)																	
Oil	1/8(3.2)	30																		
	1/2(12.7)	30																		
	1(25.4)	20																		
<p>Number of Cycle: 10⁷ cycles</p> <p>Amplitude (One side): 0.066 inch (1.68mm)</p> <p>Frequency: 20Hz</p>																				
Pressure Pulsation Test	<table border="1"> <thead> <tr> <th>Test Fluid</th> <th>Nominal Dia. inch(mm)</th> <th>Test Pres. (MPa)</th> </tr> </thead> <tbody> <tr> <td rowspan="3">Oil</td> <td>1/8(3.2)</td> <td>45</td> </tr> <tr> <td>1/2(12.7)</td> <td>45</td> </tr> <tr> <td>1(25.4)</td> <td>30</td> </tr> </tbody> </table>	Test Fluid	Nominal Dia. inch(mm)	Test Pres. (MPa)	Oil	1/8(3.2)	45	1/2(12.7)	45	1(25.4)	30		good (No Leakage)							
	Test Fluid	Nominal Dia. inch(mm)	Test Pres. (MPa)																	
Oil	1/8(3.2)	45																		
	1/2(12.7)	45																		
	1(25.4)	30																		
<p>Number of Cycle: 5×10⁵ Cycles</p> <p>Frequency: 30 - 100 cycles per minute</p> <p>※ Putting into effect with the Vibration (Fatigue)Test.</p>																				
																				

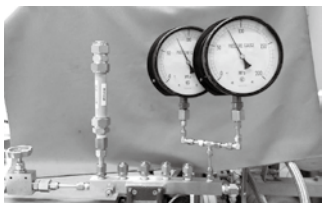
※ Please refer to the test report for details about each test.

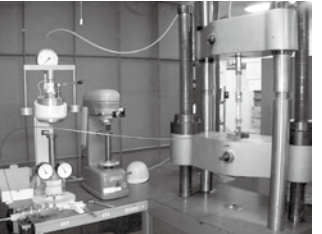
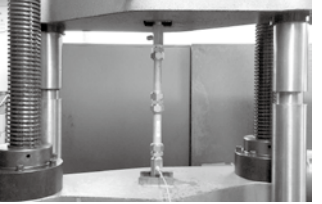
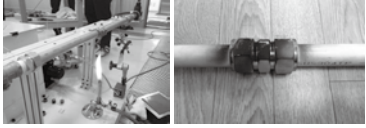
1. V-Lok PERFORMANCE CONFIRMATION TEST RESULTS (2/3)

Test Items	Test Conditions & Landscape		Results																		
Burst Pressure Test	<table border="1"> <thead> <tr> <th>Test Fluid</th> <th>Nominal Dia. inch(mm)</th> <th>Test Pres. (MPa)</th> </tr> </thead> <tbody> <tr> <td rowspan="3">H₂O</td> <td>1/8(3.2)</td> <td>45</td> </tr> <tr> <td>1/2(12.7)</td> <td>45</td> </tr> <tr> <td>1(25.4)</td> <td>30</td> </tr> </tbody> </table>	Test Fluid	Nominal Dia. inch(mm)	Test Pres. (MPa)	H ₂ O	1/8(3.2)	45	1/2(12.7)	45	1(25.4)	30	 	good (No Leakage)								
	Test Fluid	Nominal Dia. inch(mm)	Test Pres. (MPa)																		
H ₂ O	1/8(3.2)	45																			
	1/2(12.7)	45																			
	1(25.4)	30																			
Retaining Period: 5 minutes																					
Pull-out Test	<table border="1"> <thead> <tr> <th>Test Fluid</th> <th>Nominal Dia. inch(mm)</th> <th>Test Pres. (MPa)</th> </tr> </thead> <tbody> <tr> <td rowspan="3">H₂O</td> <td>1/8(3.2)</td> <td>30</td> </tr> <tr> <td>1/2(12.7)</td> <td>30</td> </tr> <tr> <td>1(25.4)</td> <td>20</td> </tr> </tbody> </table>	Test Fluid	Nominal Dia. inch(mm)	Test Pres. (MPa)	H ₂ O	1/8(3.2)	30	1/2(12.7)	30	1(25.4)	20	 	good (No Leakage, No Damage, No Displacement of Fittings and Pipes)								
	Test Fluid	Nominal Dia. inch(mm)	Test Pres. (MPa)																		
H ₂ O	1/8(3.2)	30																			
	1/2(12.7)	30																			
	1(25.4)	20																			
Axial Load: 15,202N Retaining Period: 5 minutes																					
Fire Endurance Test	<p>① Fire Test with ISO19921: 2005(E) Retaining Period: 5 minutes ISO19922: 2005(E) Test Period: 30 minutes Test Temperature: 80°C Test Pressure: 500~1000KPa ※ Confirming no destruction during Fire Endurance Test.</p>	<p>② Tightness Test</p> <table border="1"> <thead> <tr> <th>Test Fluid</th> <th>Nominal Dia. inch(mm)</th> <th>Test Pres. (MPa)</th> </tr> </thead> <tbody> <tr> <td rowspan="3">H₂O</td> <td>1/8(3.2)</td> <td>45</td> </tr> <tr> <td>1/2(12.7)</td> <td>45</td> </tr> <tr> <td>1(25.4)</td> <td>30</td> </tr> <tr> <td rowspan="3">Air</td> <td>1/8(3.2)</td> <td>7</td> </tr> <tr> <td>1/2(12.7)</td> <td>7</td> </tr> <tr> <td>1(25.4)</td> <td>7</td> </tr> </tbody> </table>	Test Fluid	Nominal Dia. inch(mm)	Test Pres. (MPa)	H ₂ O	1/8(3.2)	45	1/2(12.7)	45	1(25.4)	30	Air	1/8(3.2)	7	1/2(12.7)	7	1(25.4)	7	 	good (No Leakage)
	Test Fluid	Nominal Dia. inch(mm)	Test Pres. (MPa)																		
H ₂ O	1/8(3.2)	45																			
	1/2(12.7)	45																			
	1(25.4)	30																			
Air	1/8(3.2)	7																			
	1/2(12.7)	7																			
	1(25.4)	7																			
<p>※ Please refer to the test report for details about each test.</p>																					

1. V-Lok PERFORMANCE CONFIRMATION TEST RESULTS (3/3)

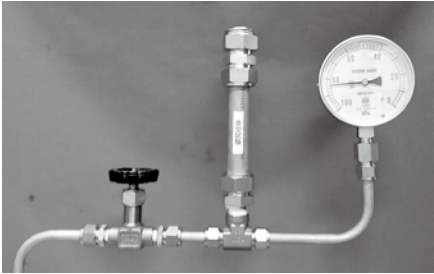
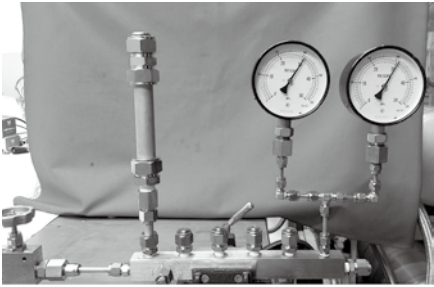
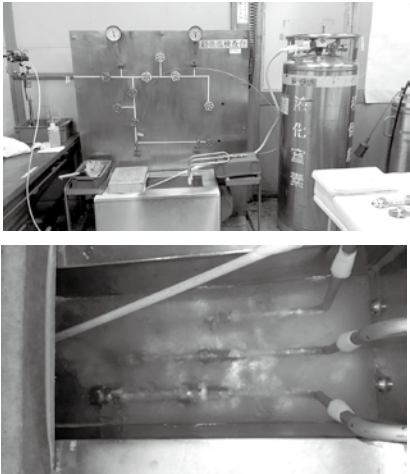
Test Items	Test Conditions & Landscape		Results																	
Vacuum Test	<table border="1"> <thead> <tr> <th>Test Fluid</th> <th>Nominal Dia. inch(mm)</th> <th>Test Pres. (kPa abs)</th> </tr> </thead> <tbody> <tr> <td rowspan="3">H₂O</td> <td>1/8(3.2)</td> <td>17</td> </tr> <tr> <td>1/2(12.7)</td> <td>17</td> </tr> <tr> <td>1(25.4)</td> <td>17</td> </tr> </tbody> </table>	Test Fluid	Nominal Dia. inch(mm)	Test Pres. (kPa abs)	H ₂ O	1/8(3.2)	17	1/2(12.7)	17	1(25.4)	17		good (No Leakage)							
	Test Fluid	Nominal Dia. inch(mm)	Test Pres. (kPa abs)																	
H ₂ O	1/8(3.2)	17																		
	1/2(12.7)	17																		
	1(25.4)	17																		
Retaining Period: 5 minutes																				
Repeated Assembly Test	<table border="1"> <thead> <tr> <th>Test Fluid</th> <th>Nominal Dia. inch(mm)</th> <th>Test Pres. (MPa)</th> </tr> </thead> <tbody> <tr> <td rowspan="3">H₂O</td> <td>1/8(3.2)</td> <td>45</td> </tr> <tr> <td>1/2(12.7)</td> <td>45</td> </tr> <tr> <td>1(25.4)</td> <td>30</td> </tr> <tr> <td rowspan="3">Air</td> <td>1/8(3.2)</td> <td>7</td> </tr> <tr> <td>1/2(12.7)</td> <td>7</td> </tr> <tr> <td>1(25.4)</td> <td>7</td> </tr> </tbody> </table>	Test Fluid	Nominal Dia. inch(mm)	Test Pres. (MPa)	H ₂ O	1/8(3.2)	45	1/2(12.7)	45	1(25.4)	30	Air	1/8(3.2)	7	1/2(12.7)	7	1(25.4)	7		good (No Leakage)
	Test Fluid	Nominal Dia. inch(mm)	Test Pres. (MPa)																	
	H ₂ O	1/8(3.2)	45																	
		1/2(12.7)	45																	
		1(25.4)	30																	
	Air	1/8(3.2)	7																	
1/2(12.7)		7																		
1(25.4)		7																		
Reassemble Times: 10 Times																				
Retaining Period: 5 minutes																				
Low Temperature Test	<table border="1"> <thead> <tr> <th>Test Fluid</th> <th>Nominal Dia. inch(mm)</th> <th>Test Pres. (MPa)</th> </tr> </thead> <tbody> <tr> <td rowspan="3">He</td> <td>1/8(3.2)</td> <td>7</td> </tr> <tr> <td>1/2(12.7)</td> <td>7</td> </tr> <tr> <td>1(25.4)</td> <td>7</td> </tr> </tbody> </table>	Test Fluid	Nominal Dia. inch(mm)	Test Pres. (MPa)	He	1/8(3.2)	7	1/2(12.7)	7	1(25.4)	7		good (No Leakage)							
	Test Fluid	Nominal Dia. inch(mm)	Test Pres. (MPa)																	
	He	1/8(3.2)	7																	
		1/2(12.7)	7																	
1(25.4)		7																		
By keeping in liquid nitrogen																				
Test Temperature: -196°C																				
Retaining Period: 10 minutes																				

※ Please refer to the test report for details about each test.

2.CERTIFICATE V-Lok Fittings

V-Lok Fitting has acquired NK(NIPPON KAIJI KYOKAI) TYPE APPROVAL CERTIFICATE.

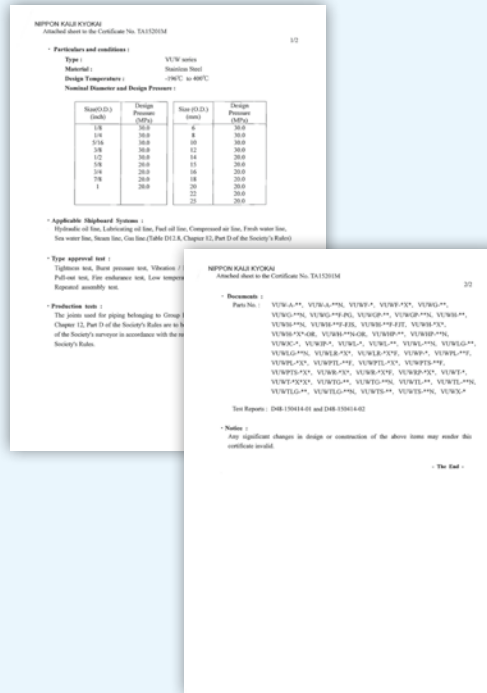
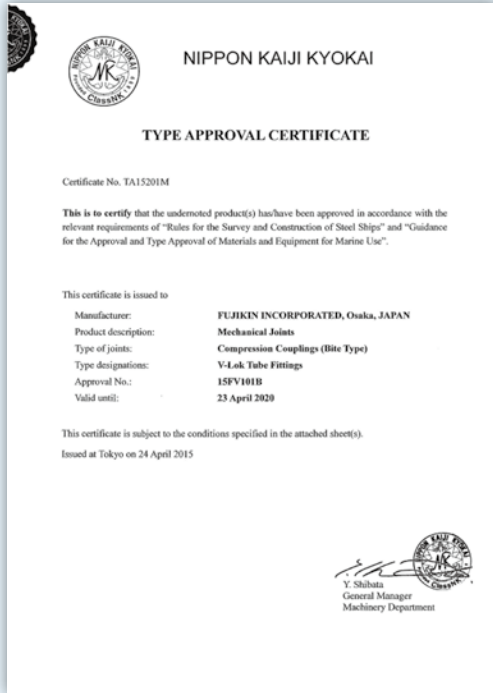

V-Lok Fitting has acquired DNV-GL CERTIFICATE COMPLIANCE OF ASTM F1387 & CERTIFICATE FOR ABS TYPE APPROVAL.



CERTIFICATE COMPLIANCE OF ASTM F1387 (DNV-GL)

CERTIFICATE FOR ABS TYPE APPROVAL.

CERTIFICATE FOR BV TYPE APPROVAL

Page 1 / 3

BUREAU VERITAS
Marine & Offshore Division
This certificate is not valid unless countersigned and signed by the authorized signatory of the Bureau Veritas Group.

Certificate number: 443373A BV
File number: ACM 135276651
Product code: 21204

TYPE APPROVAL CERTIFICATE

This certificate is issued to:
FUJIKIN INCORPORATED
Osaka - JAPAN
for the type of product:
SCREW COUPLINGS
V-Lok V200 series

Requirements:
- Bureau Veritas Rules for the Classification of Steel Ships

This certificate is issued to attest that BUREAU VERITAS has controlled the relevant approval procedures for the product identified above which may be used in compliance with the relevant regulatory requirements set out above.

This certificate will expire on: 05 May 2021

For BUREAU VERITAS,
At: KORE, on 03 Jun 2016,
Yusuf Hameed



The electronic version is available at: <http://www.veritas.com/content/dam/veritas/Products/Type%20Approval%20Certificate.pdf>
BV Mail Act 03/03/2016 10:14

Page 2 / 3
Certificate number: 443373A BV

THE SCHEDULE OF APPROVAL

1. PRODUCT DESCRIPTION
1.1 V-Lok series

1.2 Approval data

Material	Design Pressure (MPa)	Temperature (°C)	Code
V-Lok 8	10.0	150	1
V-Lok 9	10.0	150	1
V-Lok 10	10.0	150	1
V-Lok 11	10.0	150	1
V-Lok 12	10.0	150	1
V-Lok 13	10.0	150	1
V-Lok 14	10.0	150	1
V-Lok 15	10.0	150	1
V-Lok 16	10.0	150	1
V-Lok 17	10.0	150	1
V-Lok 18	10.0	150	1
V-Lok 19	10.0	150	1
V-Lok 20	10.0	150	1
V-Lok 21	10.0	150	1
V-Lok 22	10.0	150	1
V-Lok 23	10.0	150	1
V-Lok 24	10.0	150	1
V-Lok 25	10.0	150	1
V-Lok 26	10.0	150	1
V-Lok 27	10.0	150	1
V-Lok 28	10.0	150	1
V-Lok 29	10.0	150	1
V-Lok 30	10.0	150	1
V-Lok 31	10.0	150	1
V-Lok 32	10.0	150	1
V-Lok 33	10.0	150	1
V-Lok 34	10.0	150	1
V-Lok 35	10.0	150	1
V-Lok 36	10.0	150	1
V-Lok 37	10.0	150	1
V-Lok 38	10.0	150	1
V-Lok 39	10.0	150	1
V-Lok 40	10.0	150	1
V-Lok 41	10.0	150	1
V-Lok 42	10.0	150	1
V-Lok 43	10.0	150	1
V-Lok 44	10.0	150	1
V-Lok 45	10.0	150	1
V-Lok 46	10.0	150	1
V-Lok 47	10.0	150	1
V-Lok 48	10.0	150	1
V-Lok 49	10.0	150	1
V-Lok 50	10.0	150	1

1.3 Approval data

1.4 Approval data

Page 3 / 3
Certificate number: 443373A BV

2.1 Approval data

2.2 Approval data

2.3 Approval data

2.4 Approval data

2.5 Approval data

2.6 Approval data

2.7 Approval data

2.8 Approval data

2.9 Approval data

2.10 Approval data

2.11 Approval data

2.12 Approval data

2.13 Approval data

2.14 Approval data

2.15 Approval data

2.16 Approval data

2.17 Approval data

2.18 Approval data

2.19 Approval data

2.20 Approval data

2.21 Approval data

2.22 Approval data

2.23 Approval data

2.24 Approval data

2.25 Approval data

2.26 Approval data

2.27 Approval data

2.28 Approval data

2.29 Approval data

2.30 Approval data

2.31 Approval data

2.32 Approval data

2.33 Approval data

2.34 Approval data

2.35 Approval data

2.36 Approval data

2.37 Approval data

2.38 Approval data

2.39 Approval data

2.40 Approval data

2.41 Approval data

2.42 Approval data

2.43 Approval data

2.44 Approval data

2.45 Approval data

2.46 Approval data

2.47 Approval data

2.48 Approval data

2.49 Approval data

2.50 Approval data

2.51 Approval data

2.52 Approval data

2.53 Approval data

2.54 Approval data

2.55 Approval data

2.56 Approval data

2.57 Approval data

2.58 Approval data

2.59 Approval data

2.60 Approval data

2.61 Approval data

2.62 Approval data

2.63 Approval data

2.64 Approval data

2.65 Approval data

2.66 Approval data

2.67 Approval data

2.68 Approval data

2.69 Approval data

2.70 Approval data

2.71 Approval data

2.72 Approval data

2.73 Approval data

2.74 Approval data

2.75 Approval data

2.76 Approval data

2.77 Approval data

2.78 Approval data

2.79 Approval data

2.80 Approval data

2.81 Approval data

2.82 Approval data

2.83 Approval data

2.84 Approval data

2.85 Approval data

2.86 Approval data

2.87 Approval data

2.88 Approval data

2.89 Approval data

2.90 Approval data

2.91 Approval data

2.92 Approval data

2.93 Approval data

2.94 Approval data

2.95 Approval data

2.96 Approval data

2.97 Approval data

2.98 Approval data

2.99 Approval data

2.100 Approval data

Lloyd's Register Type Approval Certificate

Lloyd's Register

Type Approval Certificate

This is to certify that the (underlined product) has been tested with satisfactory results in accordance with the relevant requirements of the Lloyd's Register Type Approval System.

This certificate is issued to:

PRODUCER Fujikin Incorporated
PLACE OF PRODUCTION Fujikin Incorporated, Osaka Plant, Kashiwara 100-01, Enryo-cho, Kashiwara, Osaka, Japan
DESCRIPTION Stainless steel compression type mechanical tube fittings
TYPE V-Lok series mechanical tube fittings
APPLICATION Hydraulic & pneumatic fluid, gas, lubricating oil, fuel oil and instrument control system
STANDARD Lloyd's Register Rules and Regulations for Classification of Ships Part 5, Chapter 12 - January 2016
RATINGS Nominal Diameter: from 1/8" to 1" (from 3mm to 25 mm)
Design Pressure: from 32.4 MPa to 79.3 MPa (depending on Nominal Diameter)

PERFORMANCE TEST

- Vibration test
- Pressure pulsation test
- Tightness test
- Pull-out test
- Vacuum test
- Repeated assembly test
- Burst pressure test

Certificate No. 16/1002
Issue Date 23 May 2016
Expiry Date 22 May 2021
Sheet 1 of 2

N. Nagamine
Yokohama Technical Support Office
Lloyd's Register Group Limited

Lloyd's Register Group Limited, 71 Fincham Street, London EC3M 4BS

Lloyd's Register

OTHER CONDITIONS

- The fittings are to be installed in accordance with the manufacturer's instructions.
- Attention is drawn to Section 3.6 of IMO MSC/Circular#51 - Guidelines on Engine-Room Oil Fuel Systems which describes that compression couplings require careful attention to tightening procedures and torques to avoid leaks or damage to the pipe when subjected to overtightening and they should not be used in the fuel supply line of the (oil engine) injection pumps and spill system.

"This Certificate is not valid for equipment, the design, ratings or operating parameters of which have been varied from the specimens tested. The manufacturer should notify Lloyd's Register Group Limited of any modification or changes to the equipment in order to obtain a valid certificate."

The Design Approval Document No. 16/3012 and its supplementary Type Approval Terms and Conditions form part of this Certificate.

Certificate No. 16/1002
Issue Date 23 May 2016
Expiry Date 22 May 2021
Sheet 2 of 2

N. Nagamine
Yokohama Technical Support Office
Lloyd's Register Group Limited

Lloyd's Register Group Limited, 71 Fincham Street, London EC3M 4BS

3.REMARKS

3-1. Special materials(Tantalum, Titanium, Hastelloy, Monel) are available. Please contact **Fujikin** .

3-2. When needing for perfect oil-free products, please inform **Fujikin** with use conditions beforehand.

Index

INDEX

	P
APDM-VUBV-115	119
APDM-VUBV-915	119
APDM-VUBV-920P	112
APDM-VUBVS-920P	112
APR-VUBV-115	118
APR-VUBV-915	118
APR-VUBV-920P	111
APR-VUBVS-920P	111
AR2000	184
MINUCON	181
PDS	141
PDW	101, 102
PDWF	89
PDWG	91, 92
PDWGP	93
PDWH	87
PDWHP	88
PDWJC	100
PDWJP	100
PDWL	94, 95
PDWP	90
PDWT	96
PDWTG	97
PDWTL	99
PDWTS	98
PDWVP	143, 144
SR100	182
SR100E	183
SR100M	184

	P
UJB	83
UJN	84
UJS	83
VUBF-76P	163
VUBF-96P	163
VUBFD-76P	163
VUBFD-96P	163
VUBFH-96P	165
VUBFN-74MP	167
VUBFN-94MP	167
VUBV-115	116, 117
VUBV-915	116
VUBV-020P	110
VUBV-141P	125
VUBV-168P	125
VUBV-920P	109
VUBV-941P	125
VUBV-968P	125
VUBVS-020P	110
VUBVS-920P	109
VUBVST-920P	110
VUBVT-920P	110
VUBVT-141P	125
VUBVT-168P	125
VUBVT-941P	125
VUBVT-968P	125
VUCL-141	178
VUCL-941	178
VUH-141P	133
VUH-168P	134

INDEX

	P
VUH-941P	133
VUH-968P	134
VUHGB-141DN	159
VUK-01P.....	171
VUK-11P.....	170
VUK-31P.....	171
VUK-91P.....	170
VUH-134P	137
VUH-934P	137
VUP-120.....	128
VUP-920.....	128
VURF-041L.....	175
VURF-341L.....	175
VUT-141D	150
VUT-141L	151, 152
VUT-141LV	154, 155
VUT-141V	153
VUTW-141.....	147
VUTW-141L	148, 149
VUW	15, 16, 75
VUW-A	71, 72, 73, 74
VUWF.....	17, 18, 19, 75
VUWG.....	24, 25, 26, 27, 28
VUW-GA	67, 68, 69, 70
VUWGP	61
VUWH.....	34, 35, 36, 37, 38, 39, 40, 41, 42
VUWHP	62, 63

	P
VUW-IN	16
VUWJC	65
VUWJP	66
VUWL	23, 45, 46, 47, 48
VUWLG	50, 51
VUWLR	49
VUWP	60
VUW-PC	32, 33
VUWPL	76, 79
VUWPTL	77, 80
VUWPTS	77, 80
VUWR	29, 30, 31, 43, 44
VUWRF	44
VUWRP	61
VUWT	20, 21, 22, 75
VUWTG	58, 59
VUWTL	52, 53
VUWTLG	54, 55
VUWTS	56, 57
VUWX	64

memo

Fittings

- V-Lok Tube Fittings - Stainless Steel
- PDW Tube Fittings - Brass

V-Lok Tube Fittings - Stainless Steel



PDW Tube Fittings - Brass



Valves

- Ball Valves
- 3-Pieces Ball Valves
- Trunnion Ball Valves
- Plug Valves
- Union-Bonnet Needle Valves
- Integral-Bonnet Needle Stop Valves
- Brass Needle Stop Valves
- Instrument Manifolds / Gauge Valves
- Bellows Valves
- Toggle Valves
- Relief Valves
- Check Valves

Ball Valves



3-Pieces Ball Valves



Trunnion Ball Valves



Plug Valves



Union-Bonnet Needle Valves



Integral-Bonnet Needle Stop Valves



Brass Needle Stop Valves



Instrument Manifolds / Gauge Valves



Bellows Valves



Toggle Valves



Relief Valves



Check Valves



Other Related Products

Automatic Flow Control Valve Series

- Diaphragm Type - Micro Control Valve - MINDICOR Series
- Electric Valve - 20-100 Series
- Electric Valve - 40-100 Series
- Electric Valve - 40-100 Series
- Electric Valve - 40-100 Series

Others

- FINE BUBBLE - Leak Detection Fluid

Automatic Flow Control Valve Series







FINE BUBBLE Leak Detection Fluid



Technical Data

- V-Lok Tube Fittings - Stainless Steel
- PDW Tube Fittings - Brass
- Ball Valves
- 3-Pieces Ball Valves
- Trunnion Ball Valves
- Plug Valves
- Union-Bonnet Needle Valves
- Integral-Bonnet Needle Stop Valves
- Brass Needle Stop Valves
- Instrument Manifolds / Gauge Valves
- Bellows Valves
- Toggle Valves
- Relief Valves
- Check Valves



Fujikin Carp Group



The Year 2013 Prime Minister's Prize
The 5th Monodzukuri Nippon Grand Award
Overseas Operation "Excellence Prize"

URL <http://www.fujikin.co.jp/> E-mail info@fujikin.co.jp